



GASTRONOMY,

SERVICE,

HOSPITALITY

& MORE.

pujadas[®]
A VOLLRATH[®] COMPANY



Ctra. de Castanyet, 132 - P.O.Box 121
17430 Santa Coloma de Farners
(GIRONA) - SPAIN

Ventas en España

Tel. 972 84 32 01
Fax 972 84 35 27
info@pujadas.es

Export Department

Tel. +34 972 84 32 01
Fax +34 972 84 35 27
info@pujadas.es

www.pujadas.es
info@pujadas.es

ÍNDICE / INDEX / TABLE / INDEX

COCINA / KITCHEN / CUISINE / KÜCHE



1 BATERÍA DE COCINA / COOKWARE / BATTERIE DE CUISINE / KOCHBEDARF

1.1	INOX-PRO	20
1.2	TOP LINE	28
1.3	VIOLET COLLECTION	30
1.4	COOL•LINE	32
1.5	IDEA	34
1.6	DAILY	36
1.7	ALU-PRO	37
1.8	BLACK SERIES	41
1.9	BLACK FORGED	42
1.10	MULTIMETAL	43

3 HORNO Y RUSTIDERAS / OVEN AND ROAST PAN / FOUR ET PLAQUES À RÔTIR / OFEN- UND BRATFORMEN

3.1	RUSTIDERAS / ROAST PANS / PLAQUES À RÔTIR / BRÄTER	68
3.2	BANDEJAS HORNO GASTRONORM / GASTRONORM SHEET PANS / PLAQUES FOUR GASTRONORME / GASTRONORM OFENBLECHE	70
3.3	BANDEJAS PASTELERÍA / PASTRY TRAYS / PLAQUES À PÂTISSERIE / PÂTISSERIETABLETT	72
3.4	REJILLAS / GRIDS / GRILLES / ROST	74
3.5	BANDEJAS ESPECIALES / SPECIAL BAKING SHEET / PLAQUE FOUR SPÉCIALE / SPEZIALBLECHE	75
3.6	BANDEJAS PARA PIZZA / PIZZA BAKING SHEETS / PLAQUES À PIZZA / PIZZABLECHE	77
3.7	ACCESORIOS HORNO / OVEN ACCESSORIES / ACCESSOIRES FOUR / OFENACCESSORIES	78

2 SARTENES / FRY PANS / POÊLES / PFANNEN

2.1	ACERO INOXIDABLE / ST/STEEL / ACIER INOXYDABLE / EDELSTAHL	50
2.2	ALUMINIO / ALUMINIUM / ALUMINIUM / ALUMINIUM	53
2.3	MULTIMETAL / MULTI-PLY / MULTI-METAL / MULTIMETALL	57
2.4	ALUMINIO FUNDICIÓN / CAST ALUMINIUM / FONTE D'ALUMINIUM / ALUMINIUMGUSS	58
2.5	ACERO / STEEL / ACIER / ROSTFREIER STAHL	61
2.6	PAELLERA / SPANISH PAELLA PAN / PLAT À PAELLA / PAELLAPFANNE	64

4 UTENSILIOS DE COCINA / KITCHEN UTENSILS / USTENSILES DE CUISINE / KÜCHENUTENSILIEN

4.1	UTENSILIOS DE COCINA / KITCHEN UTENSILS / USTENSILES DE CUISINE / KÜCHENUTENSILIEN	82 110
4.2	VIOLET COLLECTION	101
4.3	PROCESADORES MANUALES DE ALIMENTOS / MANUAL FOOD PROCESSORS / APPAREILS MANUELS DE TRANSFORMATION DES ALIMENTS / HANDLICHEN SCHNEIDEMASCHINEN GEEIGNET FÜR	121
4.4	TABLAS DE CORTE / CUTTING BOARDS / PLANCHES À DÉCOUPER / SCHNEIDBRETTER	138
4.5	ELEMENTOS DE MEDIDA / MEASURING UTENSILS / USTENSILES DE MESURE / MESSUTENSILIEN	141
4.6	MANOPLA / MITT / GAN / HANDSCHUHE	146
4.7	ALFOMBRAS CAUCHO / NATURAL RUBBER MATS / TAPIS EN CAOUTCHOUC / KAUTSCHUKMATTEN	147

TRANSPORTE Y ALMACENAMIENTO / TRANSPORT AND STORAGE / TRANSPORT ET STOCKAGE / TRANSPORT UND LAGERUNG



5 CUBETAS GASTRONORM / GASTRONORM CONTAINERS / BACS GASTRONORME / GASTRONORM BEHÄLTER

5.1	INOX 18/10 / 18/10 ST/STEEL / INOX 18/10 / EDELSTAHL 18/10	156
5.2	CUBETAS GN SP3 / SP3 GN PANS / BACS GN SP3 / GASTRONORM BEHÄLTER SP3 /	159
5.3	COMPLEMENTOS GASTRONORM / GASTRONORM ACCESSORIES / ACCESSOIRES GASTRONORME / GASTRONORM ASSESSOIRES	163
5.4	CON FONDO DIFUSOR / WITH SANDWICH BOTTOM / AVEC FOND THERMO-DIFFUSEUR / MIT SANDWICHBODEN	165
5.5	POLICARBONATO / POLYCARBONATE / POLYCARBONATE / POLYCARBONAT	166
5.6	SIN BISFENOL-A / BISPHENOL-A FREE / SANS BISPHÉNOL-A / OHNE BISFENOL-A	168
5.7	POLIPROPILENO / POLYPROPYLENE / POLYPROPYLÈNE / POLYPROPYLEN	170
5.8	VIOLET COLLECTION	172

6 CESTAS PARA VAJILLA / DISHWASHER RACKS / CASIERS À VAISSELLE / SPÜLMASCHINENKÖRBE

6.1	CESTAS BASE Y SUPLEMENTOS / RACKS AND EXTENDERS / PANIERS BASE ET RÉHAUSSE / BASISKÖRBE UND ERWEITERUNGEN	180
6.2	COMPLEMENTOS / COMPLEMENTS / COMPLÈMENTS / ZUBEHÖR	186
6.3	CESTAS PARA PLATOS / PLATE RACKS / CASIERS ASSIETTES / TELLERSPÜLKÖRBE	188
6.4	CESTAS SIGNATURE / SIGNATURE RACKS / CASIERS SIGNATURE / SPÜLKÖRBE SIGNATURE	192

7 CARROS / TROLLEYS / CHARIOTS / SERVIERWAGEN

7.1	CARROS DE SERVICIO ALUMINIO / ALUMINIUM SERVING TROLLES / CHARIOTS DE SERVICE EN ALUMINIUM / SERVICEWAGEN AUS ALUMINIUM	200
7.2	CARROS DE SERVICIO ACERO INOXIDABLE / ST/STEEL SERVING TROLLEYS / CHARIOTS DE SERVICE EN ACIER INOXYDABLE / SERVIERWAGEN AUS EDELSTAHL	201
7.3	CARROS GUÍAS EN ACERO INOXIDABLE / ST/STEEL RAIL TROLLEYS / CHARIOTS À GLISSIÈRES EN ACIER INOXYDABLE / SERVIERWAGEN MIT EINSCHÜBEN AUS EDELSTAHL	204
7.4	CARROS ESPECIALES / SPECIAL TROLLEYS / CHARIOTS SPÉCIAUX / SPEZIALWAGEN	210



8 ESTANTERÍAS / SHELVING / ÉTAGÈRES / REGALE

8.1	COMPONENTES ESTANTERÍA / SHELVING PARTS / COMPONENTS ÉTAGÈRES / REGAL KOMPONENTEN	221
8.2	KIT ESTANTERÍA / SHELVING KITS / KITS ÉTAGÈRES / REGAL SETS	225

9 HELADERÍA Y PASTELERÍA / ICE-CREAM UTENSILS & PASTRY / USTENSILES À GLACE ET PÂTISSERIE / ZUBEHÖR FÜR EISCREME UND PATISSERIE

9.1	HELADERÍA / ICE-CREAM UTENSILS / USTENSILES POUR GLACE / ZUBEHÖR FÜR EISCREME	238
9.2	UTENSILIOS DE PASTELERÍA / PASTRY UTENSILS / USTENSILES DE PÂTISSERIE / PATISSERIEZUBEHÖR	242
9.3	MOLDES ANTIADHERENTES / NON-STICK MOULDS / MOULES ANTI-ADHÉSIFS / ANTIHAFT BACKFORMEN	255
9.4	CORTAPASTAS / PASTRY CUTTER / DÉCOUPOIRS / TEIGSCHNEIDER	259
9.5	MOLDES ACERO INOXIDABLE / ST/STEEL PASTRY MOULDS / MOULES EN ACIER INOX / BACKFORMEN ROSTFREIER STAHL	260
9.6	MANGAS Y BOQUILLAS / BAGS AND TUBES / POCHES ET DOUILLES / SPRITZBEUTEL UND TÜLLEN	263
9.7	MOLDES SILICONA / SILICONE MOULDS / MOULES SILICONE / SILIKONBACKFORMEN	269
9.8	MOLDES FLEXIPAN / FLEXIPAN MOULDS / MOULES FLEXIPAN / FLEXIPANBACKFORMEN	274



10 MAQUINARIA / EQUIPMENT / EQUIPEMENT / KÜCHENASCHINEN

10.1	COCCIÓN / COOKING / COUSSION / KÜCHENMACHINEN	284
10.2	TOSTADORAS Y GRILL DE CONTACTO / TOASTEURS & CONTACT GRILLS / TOASTER ET GRILL DE CONTACT / TOASTER - KONTACKGRILL	298
10.3	PROCESADORES DE ALIMENTOS / FOOD PROCESSORS / ROBOTS MULTIFONCTION / LEBENSMITTELMASCHINE	305
10.4	MAQUINARIA MANTENEDORA DE TEMPERATURA / FOOD WARMING EQUIPMENT / APPAREILS DE MAINTEN DE TEMPEÉRATURE / WARMHALTEMASCHINEN	323
10.5	MAQUINARIA HELADERÍA / ICE-CREAM MACHINES / TURBINES À GLACE / EISMASCHINEN	344

11 MELAMINA Y PRESENTACIÓN / MELAMINE & PRESENTATION / MÉLAMINE ET PRÉSENTATION / MELAMIN UND PRÄSENTATION

360



12 BUFFET Y ACCESORIOS / BUFFET & ACCESSORIES / BUFFET ET ACCESSOIRES / BUFFET UND ZUBEHÖR

12.1	COOL -LINE COLLECTION	406
12.2	SUPER SHAPES CUBETAS PRESENTACIÓN BUFFET / BUFFET PRESENTATION STEAM TABLE PANS / BACS PRÉSENTATION BUFFET / BUFFET PRÄSENTATION DAMPFBEHEIZTE WANNEN	412
12.3	MIRAMAR® COOKWARE BATERÍA DE COCINA PARA PRESENTACIÓN / DISPLAY COOKWARE / BATTERIE DE CUISINE-PRÉSENTATION / PRÄSENTATIONS-KOCHGESCHIRR	416
12.4	CUBIC	422
12.5	PRESENTACIÓN Y EXPOSITORES / DISPLAY STANDS & DISPLAY BASKETS / PRÉSENTOIRS ET PRÉSENTOIRS CORBEILLES / PRÄSENTATIONSSTÄNDER DISPLAY-KÖRBE	448
12.6	CHAFINGS Y DISPENSADORES / CHAFERS & DISPENSERS / CHAFERS ET DISTRIBUTEURS / CHAFERS & SPENDER	456

12.7	ESTACIONES CONTORNEADAS PARA BANQUETES / CONTOURED BUFFET STATIONS / STATIONS POUR BUFFET ARRONDIES / GEWELLTE BÜFFETSTATIONEN	465
12.8	BOLS DOBLE PARED / DOUBLE WALL BOWLS / BOLS DOUBLE PAROI / DOPPELWANDIGE SCHALEN	466
12.9	BANDEJAS DE SERVICIO / SERVING TRAYS / PLATEAUX / SERVIERTABLETTS	470
12.10	UTENSILIOS DE SERVICIO / SERVING TOOLS / USTENSILES DE SERVICE BUFFET / SERVIERBESTECK	472
12.11	SEÑALIZACIÓN / SIGNS / SIGNALISATION / MARKIERUNG	482

13 SERVICIO DE MESA / TABLE SERVICE / ARTS DE TABLE / TAFELSERVICE

13.1	MINIATURAS HIERRO FUNDIDO / CAST IRON MINIATURES / MINIATURES FONTE ÉMAILLÉE / MINIATUREN GUSSEISEN	486
13.2	PRESENTACIÓN BUFFET / BUFFET PRESENTATION / PRÉSENTATION BUFFET / BUFFET-PRÄSENTATION	489
13.3	SERVICIO DE MESA / TABLE SERVICE / SERVICE DE TABLE / TISCHSERVICE	502

15 Quick Service Restaurant (QSR) COLECTIVIDADES / INSTITUTIONS / COLLECTIVITÉS / GEMEINSCHAFTSVERPFLEGUNG

15.1	LIDSAVERS DISPENSADOR DE TAPAS / LID DISPENSER / DISTRIBUTEUR DE COUVERCLE / DECKELSPENDER	534
15.2	AUTOSERVICIO / SELF-SERVICE / SERVICE DE QUALITÉ / SELFSERVICE	540
15.3	HOSPITALES Y COLECTIVIDADES / HOSPITALS AND INSTITUTIONS / HÔPITAUX ET COLLECTIVITÉS / KRANKENHÄUSER UND GEMEINSCHAFTSVERPFLEGUNG	544
15.4	DELIVERY BAGS	546



14 BAR Y CAFETERÍA / BAR & COFFEE / BAR ET CAFÉTÉRIA / BAR UND CAFETERIA

14.1	BAR	512
14.2	TÉ Y CAFETERÍA / TEA & COFFEE SERVICE / THÉ ET CAFÉTÉRIA / TEE- UND KAFFEESERVICE	524
14.3	SERVICIO DE BEBIDAS / BEVERAGE SERVICE SERVICE À BOISSONS / GETRÄNKE-SERVIC	528

	RECAMBIOS / SPARE PARTS / PIÈCES DE RECHANGE / ERSATZTEILE	552
--	---	-----

	ÍNDICE / INDEX / TABLE / INDEX	563
--	---	-----

NACIMOS EN/ WE BEGAN IN/ NOUS
SOMMES NÉS EN/ WIR BEGANNEN IM

1921

CERCA DE BARCELONA/ NEAR BARCELONA/
À CÔTÉ DE BARCELONE/ NAHE BARCELONA

SOMOS UNA EMPRESA FUNDADA SOBRE VALORES FAMILIARES/
WE ARE A COMPANY FOUNDED ON FAMILY VALUES/
NOUS SOMMES UNE ENTREPRISE FONDÉE SUR DES VALEURS FAMILIALES/
WIR SIND EIN AUF FAMILIENWERTE GEGRÜNDETES UNTERNEHMEN

PLANTILLA DE MÁS DE/ WORKFORCE OF MORE THAN/
EFFECTIFS DE PLUS DE / BELEGSCHAFT VON MEHR ALS

1.500

TRABAJADORES/
WORKERS/
EMPLOYÉS/
ARBEITERN

A NIVEL MUNDIAL/ WORLDWIDE/ AU NIVEAU INTERNATIONAL/ WELTWEIT

DISPONEMOS DE UNAS INSTALACIONES DE MÁS DE/ WE HAVE FACILITIES OF MORE THAN/
ON DISPOSE DES INSTALLATIONS DE PLUS/ WIR HABEN ANLAGEN VON MEHR ALS

25.000m²

EN ESPAÑA/ IN SPAIN/ EN ESPAGNE/ IN SPANIEN

VENDEMOS EN MÁS DE 100 PAÍSES Y DISPONEMOS DE INSTALACIONES EN USA, MEXICO, EUROPA Y ASIA/
WE SELL IN MORE THAN 100 COUNTRIES AND HAVE FACILITIES IN THE USA, MEXICO, EUROPE AND ASIA/
NOUS VENDONS DANS PLUS DE 100 PAYS ET DISPOSONS D'INSTALLATIONS AUX ÉTATS UNIS, LE MEXIQUE, EN EUROPE ET EN ASIE/
WIR VERTREIBEN IN MEHR ALS 100 LÄNDERN UND HABEN ANLAGEN IN DEN USA, MEXIKO, EUROPA UND ASIEN



WISCONSIN (USA) NEW YORK (USA) SANTA COLOMA DE FARNERS (SPAIN) XI'AN (CHINA) SHANGHAI (CHINA) GUADALAJARA (MEXICO) CANCÚN (MEXICO)

FABRICANDO Y OFRECIENDO SOLUCIONES GLOBALES EN TODOS LOS SECTORES DE LA RESTAURACIÓN/
MANUFACTURING AND OFFERING GLOBAL SOLUTIONS IN ALL SECTORS OF THE RESTORATION/
FABRICANT ET PROPOSANT DES SOLUTIONS GLOBALES DANS TOUS LES SECTEURS DE LA RESTAURATION/
WIR STELLEN GLOBALE LÖSUNGEN IN ALLEN BEREICHEN DER GASTSTÄTTENGEWERBE HER UND BIETEN DIESE AN

COMBINAMOS/ WE COMBINE/
NOUS COMBINONS/ WIR KOMBINIEREN

LA EXPERIENCIA/
EXPERIENCE/
L'EXPÉRIENCE/
ERFAHRUNG

+

LA PASIÓN/
PASSION/
LA PASSION/
PASSION

LA TECNOLOGÍA/
TECHNOLOGY/
LA TECHNOLOGIE/
TECHNOLOGIE

+

LA INNOVACIÓN/
INNOVATION/
L'INNOVATION/
INNOVATION

PARA MEJORAR Y PERFECCIONAR NUESTROS PRODUCTOS/ TO IMPROVE AND PERFECT
OUR PRODUCTS/ POUR AMÉLIORER ET PERFECTIONNER NOS PRODUITS/ ZUR VERBESSERUNG
UND PERFEKTIONIERUNG UNSERER PRODUKTE

Y CONTAMOS CON VARIAS PATENTES REGISTRADAS/ AND WE HAVE A NUMBER OF
REGISTERED PATENTS/ ET NOUS AVONS DÉPOSÉ PLUSIEURS BREVETS/
UND WIR VERFÜGEN ÜBER MEHRERE ANGEMELDETE PATENTE

EXCLUSIVE

PATENT

PENDING

SOMOS LÍDERES DE MERCADO EN EL CANAL HORECA EN ESPAÑA Y UNA DE
LAS MÁS IMPORTANTES EMPRESAS A NIVEL EUROPEO/
WE ARE MARKET LEADERS IN THE HORECA CHANNEL IN SPAIN AND ONE OF THE MOST IMPORTANT
COMPANIES IN EUROPE/
NOUS SOMMES LEADERS DU MARCHÉ DANS LE CANAL HORECA EN ESPAGNE ET L'UNE
DES PLUS IMPORTANTES ENTREPRISES D'EUROPE/
WIR SIND MARKTFÜHRER IM SPANISCHEN HORECA-KANAL UND EINES
DER WICHTIGSTEN UNTERNEHMEN IN EUROPA

Y DESDE 2015 SOMOS PARTE DEL GRUPO/
AND FROM 2015 WE HAVE FORMED PART OF A GROUP/
ET DEPUIS 2015 NOUS FAISONS PARTIE DU GROUPE/
UND SEIT 2015 SIND WIR TEIL DER GRUPPE



COMPAÑÍA PIONERA Y LÍDER MUNDIAL EN TODO TIPO DE NEGOCIOS/
PIONEERING COMPANY LEADING THE WORLD IN ALL TYPES OF BUSINESS/
SOCIÉTÉ PIONNIÈRE ET LEADER MONDIALE DANS TOUS TYPES D'ACTIVITÉS/
PIONIER UND WELTWEITER MARKTFÜHRER IN GESCHÄFTEN ALLER ART



HOTELERÍA/
HOTELS/
HÔTELLERIE/
HOTELLERIE



RESTAURACIÓN/
RESTAURANTS/
RESTAURATION/
GASTSTÄTTENGEWERBE



RES. ORGANIZADA/
RES. CHAINS/
RES. ORGANISÉE/
GASTRONOMIEKETTEN/



COLECTIVIDADES/
INSTITUTIONS/
COLLECTIVITÉS/
GEMEINSCHAFTS-
VERPFLEGUNG



BAR Y CAFETERÍA/
BARS AND CAFÉS/
BAR ET CAFÉTERIA/
BAR UND CAFETERIA



CATERING Y EVENTOS/
CATERING AND EVENTS/
CATERING ET ÉVÈNEMENTS/
CATERING UND
VERANSTALTUNGEN

FORMADA POR UN GRAN EQUIPO DE EXPERTOS Y MÁS DE/
FORMED BY A WIDE TEAM OF EXPERTS AND MORE THAN/
COMPOSÉE D'UNE GRANDE ÉQUIPE D'EXPERTS ET DE PLUS DE/
BESTEHEND AUS EINEM GROSSEN EXPERTENTEAM UND MEHR ALS

100 + 150 = 250

PUJADAS

VOLLRATH

AÑOS/ YEARS/
ANS/ JAHRE

DE EXPERIENCIA/ OF EXPERIENCE/
D'EXPÉRIENCE/ ERFAHRUNG

CON SOPORTE DE VENTAS, SERVICIO, Y ALMACENES EN/
WITH SALES SUPPORT, SERVICE AND WAREHOUSING IN/
AVEC SUPPORT DE VENTES, SERVICE, ET ENTREPÔTS À/
MIT VERTRIEBS-, SERVICE- UND LAGER-SUPPORT IN

ESTADOS UNIDOS/
THE UNITED STATES/
ÉTATS-UNIS/
USA

MÉXICO
MEXICO/
MEXIQUE/
MEXIKO

pujadas
A VOLLRATH COMPANY
EUROPA/
EUROPE/

CHINA/
CHINE

Y OFRECIENDO PRODUCTOS DE LA MÁXIMA CALIDAD, COMO CORSAIR/
AND OFFERING THE HIGHEST QUALITY PRODUCTS SUCH AS CORSAIR/
ET OFFRANT DES PRODUITS DE QUALITÉ SUPÉRIEURE, COMM CORSAIR/
UND WIR BIETEN PRODUKTE ERSTKLASSIGER QUALITÄT, WIE CORSAIR

JUNTOS DESARROLLAMOS PRODUCTOS QUE PIENSAN EN LA EFICIENCIA ENERGÉTICA,
LA DURABILIDAD Y EL CONTROL DE LA MERMA ALIMENTARIA/
TOGETHER WE DEVELOP PRODUCTS DESIGNED FOR ENERGY EFFICIENCY,
DURABILITY AND TO REDUCE FOOD WASTE/
ENSEMBLE NOUS DÉVELOPPONS DES PRODUITS QUI TIENNENT COMPTE DE L'EFFICACITÉ ÉNERGÉTIQUE,
DE LA DURABILITÉ ET DU CONTRÔLE DU GASPILLAGE ALIMENTAIRE/
GEMEINSAM ENTWICKELN WIR PRODUKTE MIT HAUPTAUGENMERK AUF ENERGIEEFFIZIENZ,
HALTBARKEIT UND KONTROLLE DES NÄHRWERTVERLUSTE

OFRECEMOS/ WE OFFER/ NOUS OFFRONS/ WIR BIETEN



**SOLUCIONES GLOBALES E INNOVADORAS/
GLOBAL AND INNOVATIVE SOLUTIONS/
DES SOLUTIONS GLOBALES ET INNOVANTES/
GLOBALE UND INNOVATIVE LÖSUNGEN**

PARA TODO TIPO DE NECESIDADES / FOR ALL NEEDS/ POUR TOUS
TYPES DE BESOINS/ FÜR BEDÜRFNISSE ALLER ART

- * Estamos homologados y referenciados en las principales cadenas hoteleras y de restauración/
- * We are approved and referenced in the main hotel and restaurant chains/
- * Nous sommes homologués et référencés dans les principales chaînes hôtelières et de restauration/
- * Wir sind in den wichtigsten Hotel- und Restaurantketten anerkannt und referenziert

MÁS DE/ MORE THAN/ PLUS DE/ MEHR ALS

2.000

**CLIENTES/
CUSTOMERS/
CLIENTS/
KUNDEN**

EN EL MUNDO YA CONFÍAN EN NOSOTROS PARA EQUIPAR SUS COCINAS Y SALAS/
AROUND THE WORLD WHO TRUST US TO EQUIP THEIR KITCHENS AND DINING ROOMS/
NOUS FONT DÉJÀ CONFIANCE POUR ÉQUIPER LEURS CUISINES ET SALLES/
IN DER GANZEN WELT SETZEN BEI DER AUSSTATTUNG IHRER KÜCHEN UND GASTRÄUME IHR VERTRAUEN IN UNS

SOMOS UNA EMPRESA ENERGÉTICAMENTE/ WE ARE AN ENERGY EFFICIENT/
NOUS SOMMES UNE ENTREPRISE ÉNERGÉTIQUEMENT/ WIR SIND EIN ENERGIEEFFIZIENTES

**EFICIENTE/ COMPANY/
EFFICACE/ UNTERNEHMEN**



**LA SOSTENIBILIDAD/
SUSTAINABILITY/
LA DURABILITÉ/
NACHHALTIGKEIT**

ES UNA PRIORIDAD/ IS A PRIORITY/
EST UNE PRIORITÉ/ IST UNSERE PRIORITÄT

APOSTAMOS POR LA ENERGÍA/ WE ARE COMMITTED TO/
NOUS MISONNONS SUR L'ÉNERGIE/ WIR SETZEN AUF

100%

**RENOVABLE/
RENEWABLE ENERGY/
RENOUVELABLE/
ERNEUERBARE ENERGIE**

UTILIZAMOS ILUMINACIÓN/ WE USE/
NOUS UTILISONS L'ÉCLAIRAGE/ WIR SETZEN

**LED/ LED LIGHTING/
LED-LEUCHTEN**

EN TODA LA EMPRESA/ THROUGHOUT THE COMPANY/
DANS TOUTE L'ENTREPRISE/ IM GANZEN UNTERNEHMEN EIN

NUESTROS PROCESOS ESTÁN AUDITADOS POR PROFESIONALES EN/
OUR PROCESSES ARE AUDITED BY PROFESSIONALS FOR/
NOS PROCESSUS SONT AUDITÉS PAR DES PROFESSIONNELS DE/
UNSERE VERFAHREN WERDEN GEPRÜFT VON FACHLEUTEN FÜR

GESTIÓN DE RESIDUOS Y RECICLAJE/ WASTE MANAGEMENT AND RECYCLING/ GESTION DES DÉCHETS ET RECYCLAGE/ ABFALLMANAGEMENT UND RECYCLING

DISPONEMOS DE TRATAMIENTO Y/ WE HAVE OUR OWN/
NOUS DISPOSONS DE TRAITEMENT ET/ WIR VERFÜGEN ÜBER EINE EIGENE



DEPURACIÓN DE AGUAS/ WATER TREATMENT/ DÉPURATION DES EAUX/ KLÄRUNG VON ABWASSER

PROPIAS/ PLANT/ PROPRES

APLICAMOS LOS PROCESOS PRODUCTIVOS MÁS EFICIENTES Y/ WE APPLY THE MOST EFFICIENT
AND ECOLOGIC/ NOUS APPLIQUONS LES PROCESSUS PRODUCTIFS LES PLUS EFFICACES ET/
WIR SETZEN DIE EFFIZIENTESTEN UND

ECOLÓGICOS/ PRODUCTION PROCESSES/ ÉCOLOGIQUES/ ÖKOLOGISCHSTEN PRODUKTIONSVERFAHREN EIN

NUESTRA EMPRESA ADOPTA LOS SISTEMAS DE CALIDAD MAS AVANZADOS Y RECONOCIDOS INTERNACIONALMENTE/
OUR COMPANY HAS ADOPTED THE MOST ADVANCED AND INTERNATIONALLY RECOGNISED QUALITY SYSTEMS/
NOTRE ENTREPRISE ADOPTE LES SYSTÈMES DE QUALITÉ LES PLUS AVANCÉS ET INTERNATIONALEMENT RECONNUS/
UNSER UNTERNEHMEN WENDET MODERNSTE UND INTERNATIONAL ANERKANNTEN QUALITÄTSSYSTEME AN

CONTAMOS CON LAS CERTIFICACIONES DE REFERENCIA A NIVEL MUNDIAL/
WE HAVE BEEN AWARDED CERTIFICATIONS RECOGNISED AT A WORLDWIDE LEVEL/
NOUS POSSÉDONS LES CERTIFICATIONS DE RÉFÉRENCE AU NIVEAU MONDIAL/
WIR VERFÜGEN ÜBER DIE WELTWEIT RENOMMIERTESTEN ZERTIFIKATE



DAILY



Batería de cocina /
Cookware /
Batterie de cuisine /
Kochbedarf

P. 36

GREY SOUL



Melamina /
Melamine /
Mélamine /
Melamin

P. 364

BLACK FORGED



Batería de cocina /
Cookware /
Batterie de cuisine /
Kochbedarf

P. 42



Melamina /
Melamine /
Mélamine /
Melamin

P. 365

WATER



Placa de inducción wok /
Wok induction cooker /
Plaque à induction wok /
Induktionskochfeld wok

P. 287

COOL • LINE



Cubeta GN antiadherente con fondo difusor /
Non-stick sandwich bottom GN container /
Bac GN anti-adhésive avec fond thermo-diffuseur /
GN Behälter Antihaft mit Sandwichboden

P. 406



Melamina /
Melamine /
Mélamine /
Melamin

P. 370

WOOD

BLACK FORGED SOFT TOUCH



Sartén aluminio forjado /
Forged aluminium frying pan /
Poêle en aluminium revêtu /
Schmiedeaalu-Pfanne

P. 60



Escurridera de malla /
Mesh conical colander /
Passoire à maille /
Maschensieb

P. 114



Horno calentador de cinta /
Conveyor heating oven /
Four chauffant à bande /
Förderband-Aufwärmofen

P. 299

GOLDEN



Melamina /
Melamine /
Mélamine /
Melamin

P. 367



Reparto de alimentos /
Food delivery backpack /
Dos de livraison d'aliments /
Lebensmittel-Auslieferung

P. 546



Soportes presentación /
Display stands /
Support présentation /
Halierung Präsentation

P. 450



Llaunas presentación /
Tin plates display /
Plateaux inox présentation /
Präsentationstabletts

P. 489



Utensilios de servicio /
Serving tools /
Ustensiles de service buffet /
/ Servierbesteck

P. 477



Cubiteras /
Wine buckets /
Seaux à champagne /
Kühler

P. 512

PLANET COLORS



Lechera /
Creamer /
Crèmière /
Milchkanne

P. 524



Mangas desechables color verde /
Green disposable pastry bags /
Poches jetables vertes /
Einweg-Spritzbeutel grün

P. 264

GN CLASSIC. COLORS



GN CLASSIC. COLORS
Melamina /
Melamine /
Mélamine /
Melamin

P. 394



**BATERÍA DE COCINA /
COOKWARE /
BATTERIE DE CUISINE /
KOCHBEDARF**

1.1	INOX-PRO	20
1.2	TOP LINE	28
1.3	VIOLET COLLECTION	30
1.4	COOL•LINE	32
1.5	IDEA	34
1.6	DAILY	36
1.7	ALU-PRO	37
1.8	BLACK SERIES	41
1.9	BLACK FORGED	42
1.10	MULTIMETAL	43

PROFESIONAL / PROFESSIONAL /
PROFESSIONNEL / PROFESSIONELL

ACERO INOXIDABLE /
STAINLESS STEEL /
ACIER INOX /
ROSTFREIER STAHL

	INOX-PRO	TOP LINE	VIOLET COLLECTION	COOL • LINE	IDEA
REF / ITEM / CODE / ART.NR.					
COMPATIBLE CON / COMPATIBLE WITH / COMPATIBLE AVEC / GEEIGNET FÜR					
PRECIO / PRICE / PRIX / PREIS	€€€€	€€€€	€€	€€€	€€€
GARANTÍA AÑOS / WARRANTY YEARS / GARANTIE ANNÉES / GARANTIE JAHRE	5	5	1	4	3
CERTIFICACIÓN / CERTIFICATION / CERTIFICATION / ZERTIFIKATION					
ASAS / HANDLES / ANSES / GRIFFE	VARILLA / WIRE / FILS / DRAHT	AISLANTES / INSULATION / ISOLANTES / ISOLIERUNG	TUBULAR / TUBULAR / TUBULAIRE / TUBULÄR	FUNDICIÓN / CAST / FONTE / GUSSEISEN	DISEÑO / DESIGN / DESIGN / DESIGN
RESTAURANTE / RESTAURANT / RESTAURANT / RESTAURANT	TODO TIPO / ANY KIND / TOUST YPOS / ALLE TYPEN	GASTRONÓMICO / GASTRONOMIC / GASTRONOMIQUE / GASTRONOMIE	MEDIO / MEDIUM / MOYEN / MITTEL	GOURMET	MODERNA / MODERN / MODERNE / MODERN
MEDIDAS Ø / MEASURES Ø / MESURES Ø / MASSE Ø	12-60	12-60	20-32	16-32	12-32



ALUMINIO /
ALUMINIUM /
ALUMINIUM /
ALUMINIUM

MULTIMETAL /
MULTI-PLY /
MULTI-METAL /
MULTIMETALL

DAILY

ALU-PRO

BLACK SERIES

BLACK FORGED

MULTIMETAL



€

€

€€

€

€€€€€

1

1

2

2

5

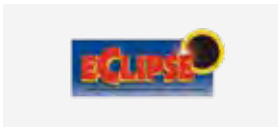
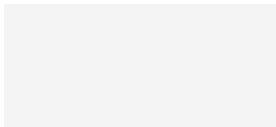
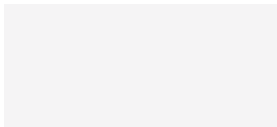

TUBULAR /
TUBULAR /
TUBULAIRE /
TUBULÄR

TUBULAR /
TUBULAR /
TUBULAIRE /
TUBULÄR

INTEGRADO /
INTEGRATED /
INTÉGRÉ /
INTEGRIERT

INTEGRADO /
INTEGRATED /
INTEGRÉ /
INTEGRIERT

TUBULAR /
TUBULAR /
TUBULAIRE /
TUBULÄR

TRADICIONAL /
TRADITIONAL /
TRADITIONNEL /
TRADITIONELL

TRADICIONAL /
TRADITIONAL /
TRADITIONNEL /
TRADITIONELL

TRADICIONAL Y
PRESENTACIÓN /
TRADITIONAL AND
PRESENTATION /
TRADITIONNEL ET
PRESENTATION /
TRADITIONELL UND
PRÄSENTATION

TRADICIONAL /
TRADITIONAL /
TRADITIONNEL /
TRADITIONELL

GASTRONÓMICO /
GASTRONOMIC /
GASTRONOMIQUE /
GASTRONOMIE

14-28

16-60

16-40

16-28

16-36

INOX-PRO



Diseñada para ofrecer el mayor rendimiento en la cocina profesional /
Specially designed to achieve the best performance in the professional cooking /
Conçue pour offrir le plus haut rendement dans la cuisine professionnelle /
Spezielles Design für die Beste Performanz in der Professionellen Küche

Cuerpo en acero inoxidable 18/10 /
Cookware body made of 18/10 stainless steel /
Corps en acier inoxydable 18/10 /
Kochkörper aus Edelstahl 18/10



SEGURA: ASAS SOLDADAS POR APORTACIÓN DE MATERIALES /
SAFETY : WELDED HANDLES BY BUILD-UP PROCESS /
SÉCURITÉ : SOUDURES DES ANSES PAR RÉSTANCE /
SICHERHEIT: ANGESCHWEISSTE GRIFFE FÜR DIE RESISTENZ



SOLIDA Y ROBUSTA: ASAS DE VARILLAS
MATIZADA
EN INOX ULTRARESISTENTES, 500 KG /

SOLID AND ROBUST: ST/STEEL WIRE HANDLE
ULTRA-RESISTANT, 500KG /

SOLIDE ET ROBUSTE : ANSES EN FIL INOX
ULTRA-RÉSISTANTES, 500KG /

SOLIDE UND ROBUST: GRIFFE AUS
EDELSTAHL DRAHT, ULTRA RESISTENT,
500KG

EFICIENTE: TAPAS DISEÑADAS PARA EL AHORRO DE ENERGÍA /
EFFICIENT: LIDS DESIGNED TO SAVE ENERGY /
EFFICIENT : COUVERCLES CONÇUS POUR ÉCONOMISER DE L'ÉNERGIE /
EFFIZIENT: ENERGIESPARENDES DECKELDESIGN

ÚNICA: IDENTIFICACIÓN DE ORIGEN Y TIPO FUENTE DE CALOR /
UNIQUE: ORIGIN IDENTIFICATION AND TYPE OF COOKING SYSTEM /
UNIQUE : IDENTIFICATION DE L'ORIGINE ET TYPE DE SYSTEME DE CUISSON /
UNIKAT: HERKUNFTSIDENFIERZUNG UND TYP DES KOCHSYSTEMS



INDUC



GAS



VITRO



ELECTR





GARANTÍA: CONTROL DE TODOS LOS PROCESOS DE FABRICACIÓN /
WARRANTY: CONTROL OF ALL PRODUCTION PROCESSES /
GARANTIE : CONTRÔLE DE TOUS LES PROCESSUS DE PRODUCTION /
GARANTIE: KONTROLLE ALLER FABRIKATIONSPROZESSE

CALIDAD: PULIDO SATINADO INTERIOR Y EXTERIOR
UNIFORME EN TODOS LOS MODELOS /

QUALITY: INNER AND OUTER SIDES OF ALL MODELS WITH
UNIFORM SATIN POLISHING /

QUALITÉ : POLISSAGE SATINÉ UNIFORME À L'INTÉRIEUR ET
L'EXTÉRIEUR DE TOUS LES MODÈLES /

QUALITÄT: SATINIERTE POLIERUNG INNEN UND AUSSEN
EINHEITLICH FÜR ALLE MODELLE

RADIOS INTERIORES DISEÑADOS PARA UNA LIMPIEZA FÁCIL Y RÁPIDA /
RADIUS SPECIALLY DESIGNED FOR EASY AND FAST CLEANING /
RAYONS PERMETTANT UN ENTRETIEN FACILE ET RAPIDE /
INNEN-RADIUS DESIGNT FÜR EINFACHE UND SCHNELLE REINIGUNG



CONTROL: SOLDADURA ARTESANAL E INSPECCIÓN EN CADA UNIDAD /
CONTROL: HANDCRAFTED WELDING AND CHECKING EVERY UNIT /
CONTRÔLE : SOUDURE ARTISANALE ET VERIFICATION DE CHAQUE UNITÉ /
KONTROLLE: HANDANGESCHWEISST UND ÜBERPRÜFUNG JEDER EINHEIT

INDUCCIÓN: FONDO SANDWICH TÉCNICO
(INOX - ALU - INOX) /

INDUCTION: TECHNICAL SANDWICH
BASE (STAINLESS STEEL - ALUMINIUM -
STAINLESS STEEL) /

INDUCTION : FOND SANDWICH
TECHNIQUE (INOX - ALU - INOX) /

INDUKTION: TECH-SANDWICHBODEN
(INOX - ALU - INOX)

EFICACIA / EFFICACY /
EFFICACITÉ / EFFIZIENZ

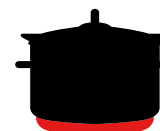

FRÍO / COLD / FROID / KÄLTE

CALIENTE / WARM / CHAUD / HITZE

Las baterías de cocina se venden sin tapa.
The cookware sold without lids.
Les batteries de cuisine sont-elles vendues sans couvercle.
Das Kochgeschirr wird ohne Deckel verkauft.

P218 Olla recta sin tapa / Stock pot without lid / Marmite traiteur sans couvercle / Hoher Kochtopf ohne Deckel

CLASS
INDUCTION NSF



REF	Ø cm	H cm	Lts	
P218.016	16	16,0	3,00	1
P218.018	18	18,0	4,50	1
P218.020	20	20,0	6,20	1
P218.024	24	24,0	10,00	1
P218.028	28	28,0	16,50	1
P218.030	30	30,0	21,20	1
P218.032	32	32,0	24,00	1
P218.035	35	35,0	33,60	1
P218.040	40	40,0	50,00	1
P218.045	45	45,0	72,00	1
P218.050	50	50,0	98,00	1
P218.060	60	55,0	155,00	1

P217 Cacerola baja sin tapa / Casserole without lid / Faitout sans couvercle / Flache Kasserolle ohne Deckel

CLASS
INDUCTION NSF



REF	Ø cm	H cm	Lts	
P217.016	16	7,5	1,50	1
P217.018	18	8,0	2,00	1
P217.020	20	8,0	2,50	1
P217.024	24	9,50	4,30	1
P217.028	28	11,0	6,70	1
P217.030	30	12,0	8,40	1
P217.032	32	12,5	10,00	1
P217.035	35	14,0	13,60	1
P217.040	40	15,5	19,50	1
P217.045	45	17,0	27,00	1
P217.050	50	20,0	39,00	1
P217.060	60	23,0	65,00	1

P216 Cacerola alta sin tapa / Sauce pot without lid / Braisière sans couvercle / Hohe Kasserolle ohne Deckel

CLASS
INDUCTION NSF



REF	Ø cm	H cm	Lts	
P216.016	16	11,0	2,10	1
P216.018	18	12,0	3,00	1
P216.020	20	13,0	4,00	1
P216.024	24	14,0	6,30	1
P216.028	28	17,5	10,20	1
P216.030	30	18,0	12,70	1
P216.032	32	19,0	15,20	1
P216.035	35	21,0	20,20	1
P216.040	40	25,0	31,40	1
P216.045	45	28,0	44,50	1
P216.050	50	30,0	59,00	1
P216.060	60	35,0	99,00	1

P205 Paellera sin tapa / Paella pan without lid / Plat à paella sans couvercle / Paellapfanne ohne Deckel

CLASS
INDUCTION NSF



REF	Ø cm	H cm	Lts	
P205.020	20	6,0	1,90	1
P205.024	24	6,0	2,70	1
P205.028	28	6,0	3,70	1
P205.030	30	6,0	4,30	1
P205.032	32	6,0	4,70	1
P205.035	35	7,0	6,70	1
P205.040	40	8,0	10,00	1
P205.045	45	8,5	12,00	1
P205.050	50	9,0	17,50	1
P205.060	60	10,0	28,00	1

P209 Tapa / Lid / Couvercle / Deckel



REF	Ø cm		📦
P209.014	14		1
P209.016	16		1
P209.018	18		1
P209.020	20		1
P209.022	22		1
P209.024	24		1
P209.028	28		1
P209.030	30		1
P209.032	32		1
P209.035	35		1
P209.040	40		1
P209.045	45		1
P209.050	50		1
P209.060	60		1

P202 Cazo recto alto / Deep saucepan /
Casserole haute / Hohe Stielkasserolle

CLASS
INDUCTION

NSF



REF	Ø cm	H cm	Lts	📦
P202.016	16	11,0	2,10	1
P202.018	18	12,0	3,00	1
P202.020	20	13,0	4,00	1
P202.024	24	14,0	6,30	1
P202.028	28	17,5	10,20	1
P202.032	32*	19,0	15,20	1

* Con contraasa / With counterhandle / Avec contre anse / Mit Zusatzgriff

P2001 Cazo con picos laterales /
Saucepan with side spouts /
Casserole avec becs verseurs /
Stielkasserolle mit Ausgüssen

CLASS
INDUCTION



REF	Ø cm	H cm	Lts	📦
P200.116	16	7,5	1,50	1
P200.120	20	10,0	3,10	1

P201 Cazo recto bajo / Saucepan /
Casserole / Stielkasserolle

CLASS
INDUCTION

NSF



REF	Ø cm	H cm	Lts	📦
P201.016	16	7,5	1,50	1
P201.018	18	8,0	2,00	1
P201.020	20	8,0	2,50	1
P201.024	24	9,5	4,30	1
P201.028	28	11,0	6,70	1
P201.032	32*	12,50	10,00	1

* Con contraasa / With counterhandle / Avec contre anse / Mit Zusatzgriff

P200 Cazo tipo francés /
French style saucepan /
Casserole forme française /
Französische Kasserolle

CLASS
INDUCTION

NSF



REF	Ø cm	H cm	Lts	📦
P200.012	12	7,0	0,70	1
P200.014	14	7,0	1,00	1
P200.016	16	7,5	1,50	1
P200.018	18	9,0	2,30	1
P200.020	20	10,0	3,10	1
P200.022	22	11,0	4,20	1
P200.024	24	12,0	5,40	1
P200.028	28	14,0	8,60	1

P214 Cazo cónico /
Conical sauté pan /
Sauteuse evasée /
Konische Stielkasserolle

CLASS
INDUCTION

NSF



REF	Ø cm	H cm	Lts	📦
P214.016	16	6,0	1,00	1
P214.018	18	6,0	1,20	1
P214.020	20	6,5	1,60	1
P214.022	22	7,0	2,10	1
P214.024	24	7,5	2,70	1

P2003 Cazo bombeado / Rounded saucepan / Casserole bombée / Kugelige Stielkasserolle mit Schüttrand

CLASS
INDUCTION



REF	Ø cm	H cm	Lts	
P200.320	20	7,5	1,80	1
P200.324	24	8,5	3,00	1

P203 Baño maría / Bain marie / Bain-marie / Wasserbad

CLASS
INDUCTION

NSF



REF	Ø cm	H cm	Lts	
P203.016	16	16,0	3,00	1
P203.018	18	18,0	4,50	1
P203.020	20	20,0	6,20	1
P203.024	24	24,0	10,00	1

Con fondo termodifusor tipo sandwich
With diffusing bottom sandwich type
Avec fond thermo diffuseur type sandwich
Mit Thermodiffusionsboden Typ Sandwich

P204 Sautex / Sauté pan / Sauteuse / Sauteuse

CLASS
INDUCTION

NSF



REF	Ø cm	H cm	Lts	
P204.020	20	6,0	1,90	1
P204.024	24	6,0	2,70	1
P204.028	28	6,0	3,70	1
P204.030	30	6,0	4,30	1
P204.032	32	6,0	4,70	1
P204.035	35	7,0	6,70	1
P204.040*	40	8,0	10,00	1

* Con contraasa / With counterhandle / Avec contre anse / Mit Zusatzgriff

VER PRODUCTOS EN / SEE PRODUCTS ON / VOIR PRODUITS EN PAGE / SIEHE PRODUKTE IN



P. 50

P240 Conjunto cuscusera bombeada, con tapa /
Conical couscous set with lid /
Couscoussier bombée avec couvercle /
Konisches Couscoustopfset mit Deckel

CLASS
INDUCTION



REF		Ø cm	H cm	Lts	
P240.040	A	40	20,0	20,00	1
	B	32	32,0	24,00	
P240.050	A	50	25,0	40,00	1
	B	40	40,0	50,00	

P242 Conjunto cuscusera forma recta /
Straight couscous set /
Couscoussier forme droite /
Couscoustopfset gerade Form

CLASS
INDUCTION



REF		Ø cm	H cm	Lts	
P242.024	A	24	14,0	6,30	1
	B	24	24,0	10,00	
P242.028	A	28	17,5	10,00	1
	B	28	28,0	16,50	
P242.032	A	32	19,0	15,00	1
	B	32	32,0	24,00	
P242.035	A	35	21,0	20,00	1
	B	35	35,0	33,60	

Con tapa / With lid / Avec couvercle / Mit Deckel

P241

Parte superior de cuscusera bombeada /
Top for couscous set conical shape /
Dessus seul pour couscoussier forme bombée /
Oberteil vom konischen Couscoustopfset



REF	Ø cm	H cm	Lts	
P241.040	40	20,0	20,00	1
P241.050	50	25,0	40,00	1

Ø agujeros / holes / trous / Löcher 4 mm
Sin tapa / Without lid / Sans couvercle / Ohne Deckel

P243

Parte superior de vaporera y cuscusera /
Top for steam pot and couscous set straight shape /
Dessus seul pour couscoussier forme droite et cuit vapeur /
Oberteil Dampfgarer und Couscoustopf



REF	Ø cm	H cm	Lts	
P243.024	24	14,0	6,30	1
P243.028	28	17,5	10,00	1
P243.032	32	19,0	15,00	1
P243.035	35	21,0	20,00	1

Ø agujeros / holes / trous / Löcher 3,25 mm
Sin tapa / Without lid / Sans couvercle / Ohne Deckel

P244 Conjunto vaporera / Steam pot /
Cuit vapeur / Dampfgarset

CLASS
INDUCTION



REF	Ø cm	H cm	Lts	📦	
P244.020	A	20	13,0	4,00	1
	B	20	13,0	4,00	
P244.024	A	24	14,0	6,30	1
	B	24	14,0	6,30	
P244.028	A	28	17,5	10,00	1
	B	28	17,5	10,00	
P244.032	A	32	19,0	15,00	1
	B	32	19,0	15,00	
P244.035	A	35	21,0	20,00	1
	B	35	21,0	20,00	

Con tapa / With lid / Avec couvercle / Mit Deckel

P224 Colapasta / Pasta colander /
Cuit-pâtes / Nudelsieb



REF	H cm	📦
P224.023	A 23,0	1
P224.026	B 26,0	1

A Utilizable para la ref. 216 - Ø 35 cm
A It fits ref. 216 - Ø 35 cm
A Utilisable pour la ref. 216 - Ø 35 cm
A Benutzbar für Art.Nr. 216 - Ø 35 cm

B Utilizable para la ref. 216 - Ø 40 cm
B It fits ref. 216 - Ø 40 cm
B Utilisable pour la ref. 216 - Ø 40 cm
B Benutzbar für Art.Nr. 216 - Ø 40 cm

P223 Conjunto cacerola + 4 colapastas /
Casserole set + 4 pasta colander /
Ensemble braisière + 4 cuit-pâtes /
Kasserolleset + 4 Nudelsiebe

CLASS
INDUCTION



REF	Ø cm	H cm	Lts	📦
P223.035	35	21,0	20,20	1
P223.040	40	25,0	31,40	1

Datos relativos a la cacerola 216.
Casserole data 216.
Caractéristiques afférentes au braisière 216.
Entsprechende Eigenschaften der Kasserolle 216.

Sin tapa / Without lid / Sans couvercle / Ohne Deckel

P248 Olla con grifo y tapa /
Stock pot with tap and lid /
Marmite traiteur avec robinet et couvercle /
Topf mit Ablaufahn und Deckel

CLASS
INDUCTION



REF	Ø cm	H cm	Lts	📦
P248.028	28	28,0	16,50	1
P248.032	32	32,0	24,00	1
P248.035	35	35,0	33,60	1
P248.040	40	40,0	50,00	1
P248.045	45	45,0	72,00	1



TOP LINE



La batería más exclusiva para la alta cocina /
 The most exclusive cookware lead to high cuisine /
 La plus exclusive batterie pour la haute cuisine /
 Exklusivster Kochbedarf für die Gehobene Küche

Cuerpo en acero inoxidable 18/10 /
 Cookware body made of 18/10 stainless steel /
 Corps en acier inoxydable 18/10 /
 Kochbedarf aus Edelstahl 18/10



FACILIDAD: ETIQUETAS IDENTIFICATIVAS DE FÁCIL EXTRACCIÓN /
 EASY: IDENTIFICATION STICKER EASY TO REMOVE /
 FACILE : ETIQUETTES IDENTIFICATRICES FACILES À ENLEVER /
 EINFACH: IDENTIFIZIERUNGSETIKETTEN LEICHT ZU ENTFERNEN

EFICIENTE: TAPAS DISEÑADAS PARA EL AHORRO DE ENERGÍA /
 EFFICIENT: LIDS DESIGNED TO SAVE ENERGY /
 EFFICIENT : COUVERCLES CONÇUS POUR ÉCONOMISER DE L'ÉNERGIE /
 EFFIZIENZ: ENERGIESPARENDES DECKELDESIGN

AISLANTE: ASAS DE INOX RESISTENTES AL CALOR /
 INSULATING: ST/STEEL HEAT RESISTANT HANDLES /
 ISOLANT : ANSES EN ACIER INOXYDABLE RÉSISTANTES À LA CHALEUR /
 ISOLIERUNG: HITZEBSTÄNDIGE GRIFFE AUS EDELSTAHL

VERTIDO FÁCIL /
 EASY POURING /
 VERCEMENT FACILE /
 SCHÜTTTRAND

ESTÉTICA: ACABADO SATINADO /
 AESTHETICS: SATIN FINISH /
 ESTHÉTIQUE : FINITION SATINÉE /
 ÄSTHETIK: SATINIERTER AUSFÜHRUNG

CALIDAD: SATINADO UNIFORME EN TODOS LOS MODELOS /
 QUALITY: UNIFORM SATIN POLISHING IN ALL MODELS /
 QUALITÉ : POLISSAGE SATINÉ UNIFORME SUR TOUS LES MODÈLES /
 QUALITÄT: EINHEITLICH MATT GLÄNZEND FÜR ALLE MODELLE

CONTROL: SOLDADURA ARTESANAL E INSPECCIÓN EN CADA UNIDAD /
 CONTROL: HANDCRAFTED WELDING AND CHECKING EVERY UNIT /
 CONTRÔLE: SOUDURE ARTISANALE ET VERIFICATION DE CHAQUE UNITÉ /
 KONTROLLE: HANDANGESCHWEISST UND ÜBERPRÜFUNG JEDER EINHEIT

INDUCCIÓN: FONDO SANDWICH TÉCNICO (INOX - ALU - INOX) /
 INDUCTION: TECHNICAL SANDWICH BASE (STAINLESS STEEL - ALUMINIUM - STAINLESS STEEL) /
 INDUCTION : FOND SANDWICH TECHNIQUE (INOX - ALU - INOX) /
 INDUKTION: TECH-SANDWICHBODEN (INOX - ALU - INOX)



INDUC



GAS



VITRO



ELECTR



EFICACIA / EFFICACY / EFFICACITÉ / EFFIZIENZ

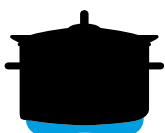

FRÍO / COLD / FROID / KÄLTE

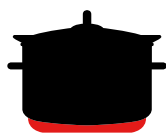

CALIENTE / WARM / CHAUD / HITZE

EFICIENCIA / EFFICACY / EFFICACITÉ / EFFIZIENZ

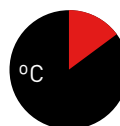

ACERO / INOX-ST/STEEL / EDELSTAHL



ALUMINIO / ALUMINIUM / ALUMINIUM

P2901 Olla recta sin tapa / Stock pot without lid / Marmite traiteur sans couvercle / Hoher Kochtopf ohne DeckelCLASS
INDUCTION

NSF



REF	Ø cm	H cm	Lts	
P290.120	20	20,0	6,20	1
P290.124	24	24,0	10,00	1
P290.128	28	28,0	16,50	1
P290.130	30	30,0	21,20	1
P290.132	32	32,0	24,00	1
P290.135	35	35,0	33,60	1
P290.140	40	40,0	50,00	1
P290.145	45	45,0	72,00	1
P290.150	50	50,0	98,00	1

P2911 Cacerola baja sin tapa / Casserole without lid / Faitout sans couvercle / Flache Kasserolle ohne DeckelCLASS
INDUCTION

NSF



REF	Ø cm	H cm	Lts	
P291.120	20	8,0	2,50	1
P291.124	24	9,5	4,30	1
P291.128	28	11,0	6,70	1
P291.130	30	12,0	8,40	1
P291.132	32	12,5	10,00	1
P291.135	35	14,0	13,60	1
P291.140	40	15,5	19,50	1
P291.145	45	17,0	27,00	1
P291.150	50	20,0	39,00	1
P291.160	60	23,0	65,00	1

P2921 Cacerola alta sin tapa / Sauce pot without lid / Braisière sans couvercle / Hohe Kasserolle ohne DeckelCLASS
INDUCTION

NSF



REF	Ø cm	H cm	Lts	
P292.120	20	13,0	4,00	1
P292.124	24	14,0	6,30	1
P292.128	28	17,5	10,20	1
P292.130	30	18,0	12,70	1
P292.132	32	19,0	15,20	1
P292.135	35	21,0	20,20	1
P292.140	40	25,0	31,40	1
P292.145	45	28,0	44,50	1
P292.150	50	30,0	59,00	1
P292.160	60	35,0	99,00	1

P2931 Paellera sin tapa / Paella pan without lid / Plat à paella sans couvercle / Paellapfanne ohne DeckelCLASS
INDUCTION

NSF



REF	Ø cm	H cm	Lts	
P293.132	32	6,0	4,70	1
P293.135	35	7,0	6,70	1
P293.140	40	8,0	10,00	1

P299 Tapa / Lid / Couvercle / Deckel

REF	Ø cm	
P299.020	20	1
P299.024	24	1
P299.028	28	1
P299.030	30	1
P299.032	32	1
P299.035	35	1
P299.040	40	1
P299.045	45	1
P299.050	50	1
P299.060	60	1



EXCLUSIVE

**INOX - ST/STEEL
EDELSTAHL
18/10**

VIOLET COLLECTION

Batería de cocina fabricada en acero inoxidable especialmente diseñada para evitar la contaminación cruzada de alérgenos.

Cookware made of stainless steel especially designed to avoid crosscontamination of allergens.

Batterie de cuisine en acier inoxydable, spécialement conçue pour éviter la contamination croisée aux allergènes.

Kochgeschirr in Edelstahl hergestellt, speziell für die Vermeidung von Kreuzkontaminationen mit Allergenen ausgelegt.

**Cacerola alta sin tapa /
Sauce pot without lid /
Braising pan without cover /
Hohe Kasserolle ohne Deckel**

P4106



REF	Ø cm	H cm	Lts	
P410.624	24	14,0	6,20	1
P410.632	32	19,0	15,00	1

**Cacerola baja sin tapa /
Casserole without lid /
Faitout sans couvercle /
Flache Kasserolle ohne Deckel**

P4107



REF	Ø cm	H cm	Lts	
P410.724	24	9,5	4,20	1
P410.732	32	12,5	10,00	1

P4109 Tapa / Lid / Couvercle / Deckel



REF	Ø cm	
P410.920	20	1
P410.924	24	1
P410.932	32	1

**P4100 Cazo recto / Saucepan /
Casserole / Hohe Kasserolle**



REF	Ø cm	H cm	Lts	
P410.020	20	10,0	3,00	1

ANTIALÉRGICO / ALLERGEN-FREE / ANTI ALLERGIQUE / ANTI ALLERGIE



PREPARE Y SIRVA COMIDAS QUE NO CONTENGAN ALÉRGENOS /
PREPARE AND SERVE ALLERGEN-FREE FOODS /
PREPAREZ ET SERVEZ DES PLATS SANS ALLERGÈNES /
MAHLZEITEN ZUBEREITEN UND SERVIEREN OHNE ALLERGENE

ENCONTRARÁS MÁS ARTÍCULOS DE ESTA GAMA EN /
PLEASE FIND MORE ITEMS FOR THIS RANGE IN /
VEUILLEZ TROUVEZ PLUS ARTICLES DE CETTE GAMME À /
BITTE FINDEN SIE MEHR ARTIKELS DIESES BEREICHS IN
P. 104

COOL • LINE

Cuerpo en acero inoxidable 18/10 /
 Cookware body made of 18/10 Stainless Steel /
 Corps en acier inoxydable 18/10 /
 Kochbedarf aus Edelstahl 18/10



ASAS ERGONÓMICAS FABRICADAS EN ACERO INOXIDABLE DE FUNDICIÓN /
 ERGONOMIC HANDLES MADE OF CAST ST/STEEL
 ANSES EN FONTE D'ACIER INOXYDABLE, ERGONOMIQUES /
 GRIFFE AUS GUSSEDELSTAHL HERGESTELLT. ABSOLUT ERGONOMISCH



PULIDO BRILLANTE /
 MIRROR POLISHING /
 POLISSAGE BRILLANT /
 GLÄNZEND POLIERT



TAPA CON DISEÑO ESPECIAL PARA APOYO EN ASA LATERAL /
 SPECIAL LID DESIGNED TO HOLD ON THE SIDE HANDLE /
 COUVERCLE SPÉCIAL, CONÇU POUR REPOSER SUR LA POIGNÉE /
 SPEZIELLES DECKELDESIGN ZUM HALTEN IM SEITENGRIF

FONDO TERMO DIFUSOR TÉCNICO /
 TECH SANDWICH BASE /
 FOND THERMO-DIFFUSEUR TECHNIQUE /
 TECH-THERMODIFFUSIONSBODEN

P4906 Cacerola alta con tapa / Sauce pot with lid / Braisière avec couvercle / Hohe Kasserolle mit Deckel



REF	Ø cm	H cm	Lts	
P490.616	16	11,0	2,00	1
P490.620	20	13,0	3,70	1
P490.624	24	14,0	5,80	1
P490.628	28	17,5	9,50	1

P4907 Cacerola baja con tapa / Casserole with lid / Faitout avec couvercle / Flache Kasserolle mit Deckel



REF	Ø cm	H cm	Lts	
P490.716	16	7,5	1,50	1
P490.720	20	8,0	2,50	1
P490.724	24	9,5	3,90	1
P490.728	28	11,0	5,80	1
P490.732	32	12,5	8,90	1

P4900 Cazo recto / Saucepan / Casserole / Gerade Stielkasserolle



REF	Ø cm	H cm	Lts	
P490.014	14	7,0	1,00	1
P490.016	16	7,5	1,50	1
P490.018	18	9,0	2,10	1
P490.020	20	10,0	3,00	1

COOL • LINE COLORS

BATERIA /
COOKWARE /
BATTERIE

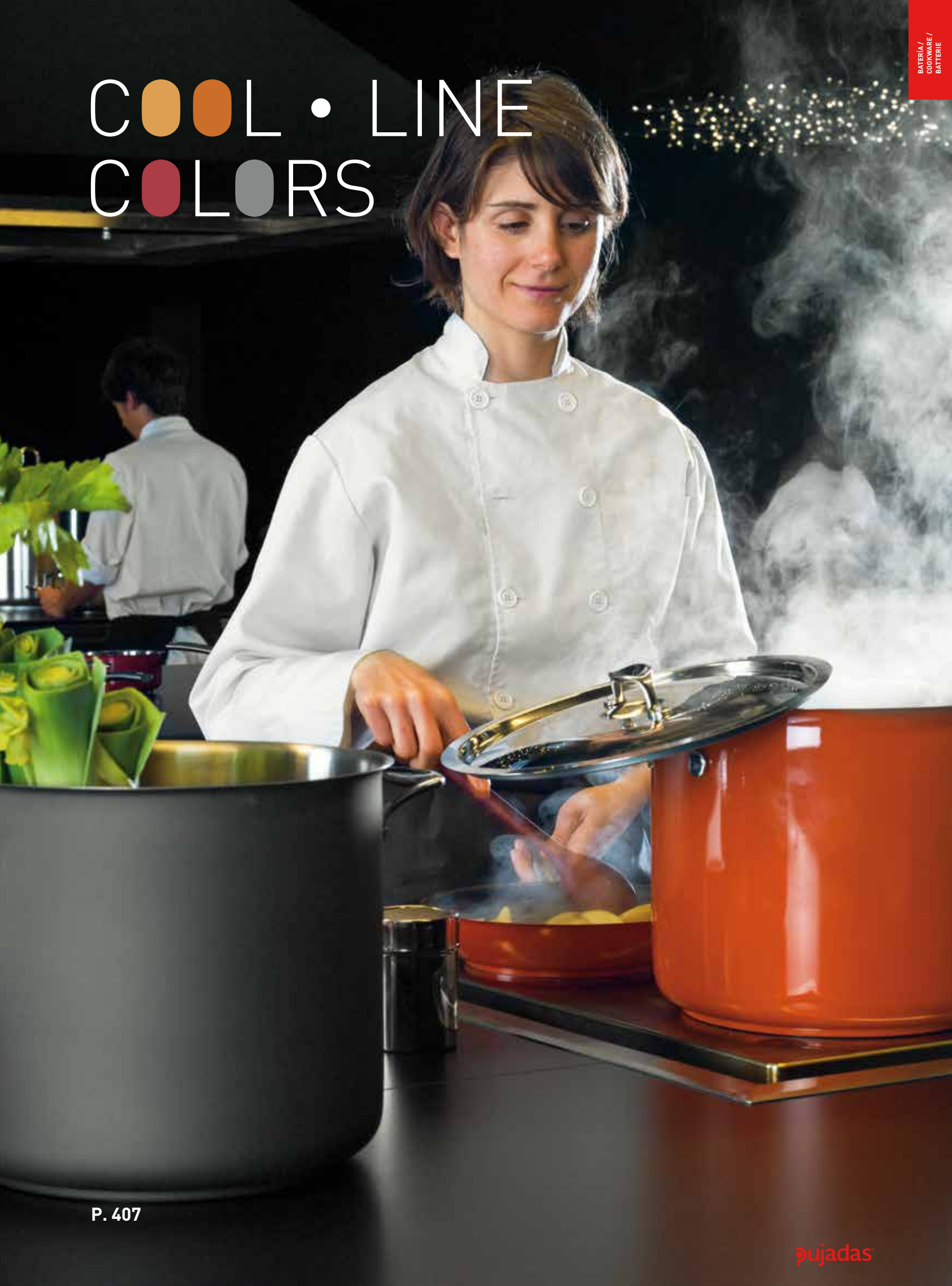

IDEA COOKWARE

Muchas veces lo más importante es la idea /
 So often, the most important point is the idea /
 Très souvent, le plus important c'est l'idée /
 Oftmals ist die Idee das Wichtigste



INDUCTION

LOS CONCURSANTES DE
 CONTESTANTS
 LES CONCURRENTS DE
 DIE KANDIDATEN

**MASTERCHEF
 IDEA**
 COCINAN CON
 COOK WITH
 CUISINENT AVEC
 KOCHEN MIT

ASAS EN ACERO INOXIDABLE /
 STAINLESS STEEL HANDLES /
 ANSES EN ACIER INOXYDABLE /
 GRIFFE AUS EDELSTAHL



ACERO INOXIDABLE PULIDO BRILLANTE /
 STAINLESS STEEL MIRROR FINISHED /
 ACIER INOXYDABLE POLISSAGE /
 GLÄNZEND POLIERTER EDELSTAHL

FONDO DIFUSOR ENCAPSULADO ALL OVER /
 ALL OVER ENCAPSULATED SANDWICH BASE /
 FOND THERMODIFFUSSEUR ENCAPSULÉ ALL OVER /
 ALL OVER VERKAPSELTER THERMODIFFUSIONSODEN

ALL OVER TECHNOLOGY

Es el nombre que recibe el proceso tecnológico que aplicamos para realizar la soldadura del fondo difusor, que permite rellenar todo el interior del fondo con una espesa capa de aluminio, sin dejar cavidades vacías y permitiendo una difusión del calor más rápida y uniforme hasta los bordes del recipiente.

Its name derives from the technological process that we apply to perform the welding of the heat diffusing base, which allows the entire inside of the base to be filled with a thick layer of aluminium, without leaving empty cavities and which allows a faster and more uniform heat diffusion right to the edges of the vessel.

C'est le nom du processus technologique que nous appliquons pour la soudure du fond diffuseur, qui permet de remplir tout l'intérieur du fond d'une couche épaisse d'aluminium, sans laisser de cavités vides et permettant une diffusion de la chaleur plus rapide et uniforme jusqu'aux bords du récipient.

Das ist die Bezeichnung des technologischen Prozesses, den wir anwenden, um das Verschweißen des Diffusionsbodens durchzuführen. Damit wird ermöglicht, den kompletten Bodenkern mit einer dicken Aluminiumschicht auszufüllen, ohne dass dabei Hohlräume entstehen, wodurch eine schnelle und gleichmäßige Wärmeverteilung bis hin zum Topfrand sichergestellt wird.

INOX / ST/STEEL
 ROSTFREIER STAHL

ALUMINIO / ALUMINIUM

INOX MAGNÉTICO /
 MAGNETIC ST/STEEL /
 INOX MAGNÉTIQUE /
 MAGNETISCHER EDELSTAHL

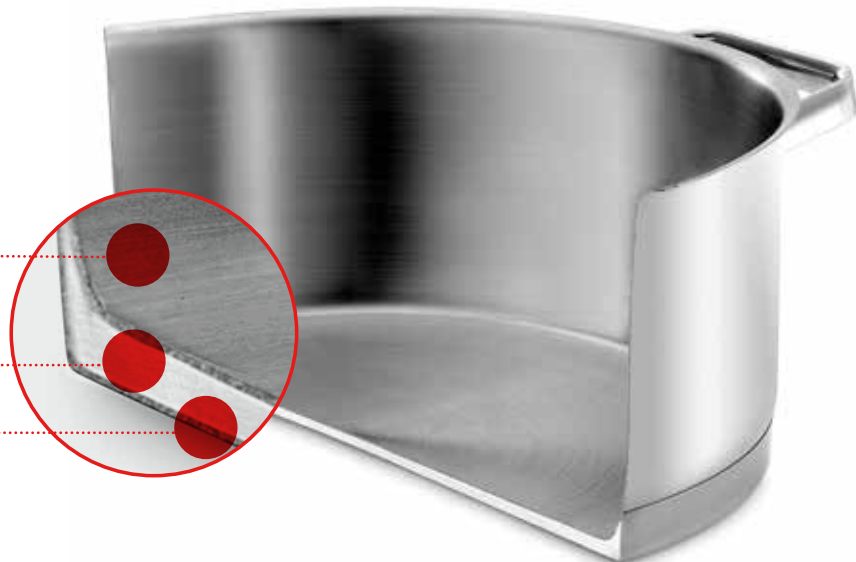

P458 Olla con tapa / Stock pot with lid / Marmite traiteur avec couvercle / Kochtopf mit Deckel



REF	Ø cm	H cm	Lts	
P458.024	24	20,0	9,00	1
P458.028	28	24,0	14,50	1

P456 Cacerola alta con tapa / Sauce pot with lid / Braisière avec couvercle / Hohe Kasserolle mit Deckel



REF	Ø cm	H cm	Lts	
P456.016	16	11,0	2,00	1
P456.020	20	13,0	4,00	1
P456.024	24	14,0	8,50	1
P456.028	28	16,0	12,50	1
P456.032	32	19,0	15,20	1

P457 Cacerola baja con tapa / Casserole with lid / Faitout avec couvercle / Flache Kasserolle mit Deckel



REF	Ø cm	H cm	Lts	
P457.016	16	7,5	1,50	1
P457.020	20	8,0	2,50	1
P457.024	24	9,5	4,30	1
P457.028	28	11,0	6,70	1

P454 Cazo recto / Saucepan / Casserole / Gerade Stielkasserolle



REF	Ø cm	H cm	Lts	
P454.012	12	7,0	0,70	1
P454.014	14	7,0	1,00	1
P454.016	16	7,5	1,50	1
P454.018	18	9,0	2,30	1

DAILY

INOX - ST/STEEL
EDELSTAHL
18/10



TAPA PLANA /
FLAT LID /
COUVERCLE PLAIN /
FLACHEM DECKEL

ASAS TUBULARES RESISTENTES AL CALOR /
HEAT-RESISTANT TUBULAR HANDLES /
ANSES TUBULAIRES RÉSITANTES À LA CHALEUR /
HITZBESTÄNDIGEN ROHRGRIFFEN

FONDO TERMO DIFUSOR ENCAPSULADO /
ENCAPSULATED SANDWICH BASE /
FOND THERMO-DIFFUSEUR ENCAPSULÉ /
KAPSELFÖRMIGER THERMODIFFUSIONSUNTERBODEN

P2706 Cacerola alta con tapa / Sauce pot with lid / Braisière avec couvercle / Hohe Kasserolle mit Deckel



REF	Ø cm	H cm	Lts	
P270.620	20	13,0	4,00	1
P270.624	24	14,0	6,00	1
P270.628	28	16,0	9,50	1

P2707 Cacerola baja con tapa / Casserole pot with lid / Faitout avec couvercle / Flache Kasserolle mit Deckel



REF	Ø cm	H cm	Lts	
P270.716	16	7,5	1,50	1
P270.720	20	8,0	2,50	1
P270.724	24	9,5	4,00	1
P270.728	28	11,0	6,50	1

P2701 Cazo recto / Saucepan / Casserole / Kasserolle



REF	Ø cm	H cm	Lts	
P270.114	14	7,0	1,00	1
P270.116	16	7,5	1,50	1
P270.118	18	9,0	2,00	1

ALU-PRO



Excelente conductividad térmica y alta eficiencia en la difusión del calor /

Excellent thermo conductivity and exceptional efficiency on heat distribution /

Excellente conductivité thermique et haute efficacité en diffusion de la chaleur /

Exzellente Wärmeleitung und hohe Effizienz der Hitzeverteilung



GAS



VITRO



ELECTR

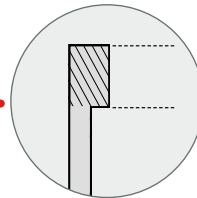
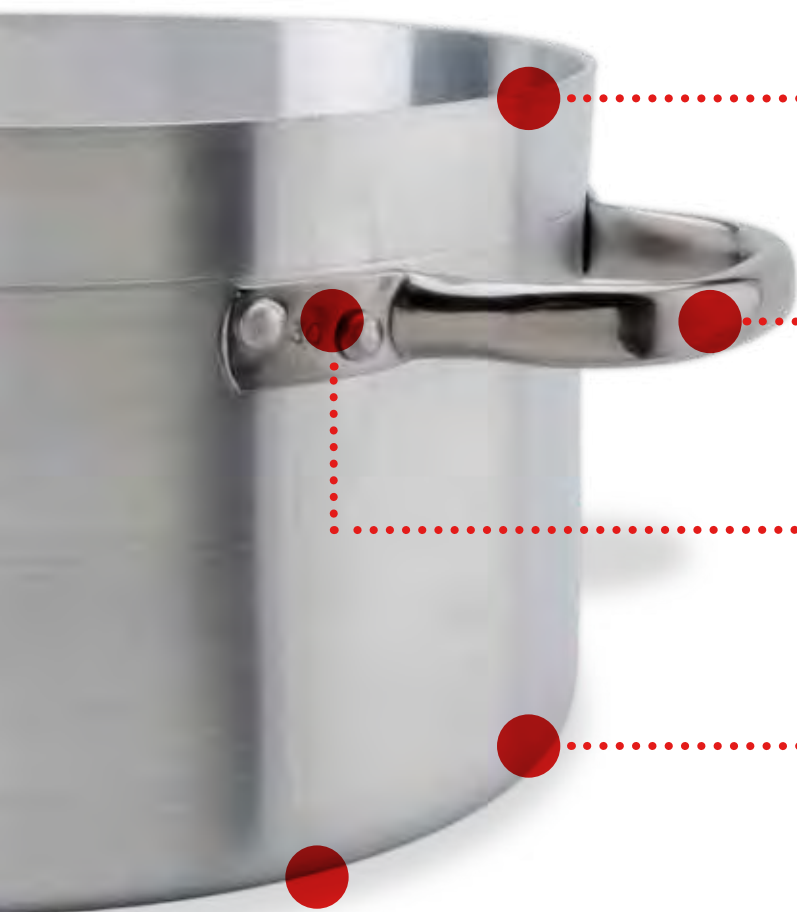

BORDES REFORZADOS /
REINFORCED RIMS /
BORDS RENFORCÉS /
VERSTÄRKTKE RÄNDER

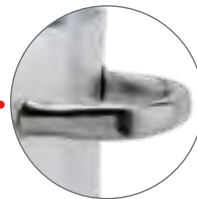

ASAS ERGONÓMICAS /
ERGONOMIC HANDLES /
ANSES ERGONOMIQUES /
ERGONOMISCHE GRIFFE



REMACHE DE ALTA RESISTENCIA /
EXTREMELY STRONG RIVETED HANDLES /
POIGNÉES RIVETÉES DE HAUTE RÉSTANCE /
EXTREM STARKE VERNIETUNG

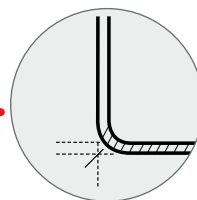

FONDO REFORZADO /
REINFORCED BASE /
FOND RENFORCÉ /
VERSTÄRKTER BODEN

BATERÍA DE ALUMINIO PURO 99,5% EXTRA FUERTE /
PURE 99,5% EXTRA STRENGTH ALUMINIUM COOKWARE /
BATTERIE DE CUISINE EN ALUMINIUM PUR À 99,5% EXTRA FORT /
KOBEDARF AUS 99,5% EXTRA STARKEN ALUMINIUM

Las baterías de cocina se venden sin tapa.

The cookware sold without lids.

Les batteries de cuisine sont-elles vendues sans couvercle.

Das Kochgeschirr wird ohne Deckel verkauft.

P1181 Olla sin tapa / Stock pot without lid / Marmite traiteur sans couvercle / Kochtopf ohne Deckel



REF	Ø cm	H cm	Lts	
P118.125	25	25,0	12,00	1
P118.127	27	27,0	15,00	1
P118.130	30	30,0	21,20	1
P118.132	32	32,0	25,50	1
P118.135	35	35,0	33,60	1
P118.140	40	40,0	50,00	1
P118.145	45	45,0	72,00	1
P118.150	50	50,0	98,00	1
P118.160	60	60,0	155,00	1

P1171 Cacerola baja sin tapa / Casserole without lid / Faitout sans couvercle / Flache Kasserolle ohne Deckel



REF	Ø cm	H cm	Lts	
P117.125	25	10,0	5,00	1
P117.127	27	11,0	6,00	1
P117.130	30	12,0	8,50	1
P117.132	32	13,0	10,00	1
P117.135	35	14,0	13,00	1
P117.138	38	15,0	17,00	1
P117.140	40	16,0	20,00	1
P117.145	45	18,0	28,00	1
P117.150	50	21,0	41,00	1
P117.160	60	25,0	70,00	1

P1161 Cacerola alta sin tapa / Sauce pot without lid / Braisière sans couvercle / Hohe Kasserolle ohne Deckel



REF	Ø cm	H cm	Lts	
P116.125	25	15,0	7,30	1
P116.130	30	18,0	12,70	1
P116.135	35	21,0	20,20	1
P116.140	40	25,0	31,40	1
P116.145	45	28,0	44,50	1
P116.150	50	31,0	60,80	1
P116.160	60	37,0	104,60	1

P115 Paellera sin tapa / Paella pan without lid / Plat à paella sans couvercle / Paellapfanne ohne Deckel



REF	Ø cm	H cm	Lts	
P115.020	20	5,5	1,75	1
P115.024	24	6,0	2,75	1
P115.028	28	6,0	3,75	1
P115.032	32	7,0	5,60	1
P115.040	40	8,0	10,00	1
P115.050	50	8,0	15,50	1
P115.060	60	10,0	28,00	1

P112 Tapa / Lid / Couvercle / Deckel



REF	Ø cm	
P112.020	20	1
P112.025	25	1
P112.027	27	1
P112.030	30	1
P112.032	32	1
P112.035	35	1
P112.038	38	1
P112.040	40	1
P112.045	45	1
P112.050	50	1
P112.060	60	1

P106 Sautex / Sauté pan / Sauteuse / Sauteuse



REF	Ø cm	H cm	Lts	
P106.020	20	5,5	1,75	1
P106.024	24	6,0	2,75	1
P106.028	28	6,0	3,75	1
P106.032	32	7,0	5,60	1
P106.040	40	8,0	10,00	1

P103 Cazo bombeado / Rounded saucepan / Casserole bombée / Kugelige Stielkasserolle mit Schüttrand



REF	Ø cm	H cm	Lts	
P103.016	16	8,0	1,00	1
P103.020	20	10,5	2,50	1
P103.022	22	11,0	3,00	1
P103.024	24	12,0	4,00	1

P104 Cazo recto / Saucepan / Casserole / Gerade Kasserolle



REF	Ø cm	H cm	Lts	
P104.018	18	9,0	2,00	1
P104.020	20	10,0	3,00	1
P104.022	22	11,0	4,00	1
P104.024	24	12,0	5,00	1

VER PRODUCTOS EN / SEE PRODUCTS ON / VOIR PRODUITS EN PAGE / SIEHE PRODUKTE IN

SARTÉN ALUMINIO ANTIATHERENTE /
ALUMINIUM NON-STICK FRY PAN /
POËL ANTI-ADHÉSIVE /
ALUMINIUM ANTIHAFT BRATPFANNE



P. 54



BLACK SERIES

FABRICADA EN ALUMINIO DE FUNDICIÓN DE GRAN RESISTENCIA A LA DEFORMACIÓN Y CON EXCELENTES PRESTACIONES TÉRMICAS /

MANUFACTURED FROM CAST ALUMINIUM OFFERING HIGH DEFORMATION RESISTANCE AND EXCELLENT THERMAL PROPERTIES /

FABRIQUÉE EN FONTE D'ALUMINIUM TRÈS RÉSISTANTE À LA DÉFORMATION ET DOTÉE D'EXCELLENTE PERFORMANCES TECHNIQUES /

AUS ALUGUSS VON HOHER FORMBESTÄNDIGKEIT UND MIT AUSGEZEICHNETER WÄRMELEITFÄHIGKEIT

ANTIADHERENTE DE ALTA RESISTENCIA /

HIGHLY RESISTANT NON-STICK SURFACE /

ANTIADHÉSIF TRÈS RÉSISTANT /

ANTIHAFTBESCHICHTUNG VON HOHER BESTÄNDIGKEIT



EXTERIOR: PINTURA NEGRA RESISTENTE A ALTAS TEMPERATURAS /

EXTERIOR: BLACK, HIGH TEMPERATURE RESISTANT PAINT /

EXTÉRIEUR : PEINTURE NOIRE RÉSISTANTE AUX TEMPÉRATURES ÉLEVÉES /

AUSSEN: HOCHTEMPERATURBESTÄNDIGE SCHWARZE LACKIERUNG



P141 Cazuela baja sin tapa / Shallow casserole without lid / Cocotte sans couvercle / Flache Kasserolle ohne Deckel



REF	Ø cm	H cm	
P141.016*	16	5,0	1
P141.020*	20	5,5	1
P141.024	24	5,8	1
P141.028	28	7,5	1
P141.032	32	8,0	1
P141.036	36	8,5	1
P141.040	40	10,0	1

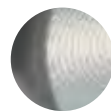

Fondo torneado /
Ground base /
Fond dressé /
Gedrechselter Unterboden

P141.016
P141.020

IDEA!

***MINI-SIZE**

Ideal para presentación.
Ideal for food presentation.
Idéal pour présentation.
Ideal für die Präsentation.

P151 Cazuela alta sin tapa / Deep casserole without lid / Braisière sans couvercle / Hohe Kasserolle ohne Deckel



REF	Ø cm	H cm	
P151.012*	12	8,5	1
P151.014*	14	8,5	1
P151.016*	16	8,0	1
P151.020	20	9,0	1
P151.024	24	10,0	1
P151.028	28	12,0	1
P151.032	32	14,0	1



Fondo torneado /
Ground base /
Fond dressé /
Gedrechselter Unterboden

P151.012
P151.014
P151.016

IDEA!

***MINI-SIZE**

Ideal para presentación.
Ideal for food presentation.
Idéal pour présentation.
Ideal für die Präsentation.

BLACK FORGED



TAPA DE CRISTAL /
GLASS LID /
COUVERCLE EN VERRE /
GLASDECKEL

ALUMINIO FORJADO CON ANTIADHERENTE EN SU INTERIOR,
I PINTURA RESISTENTE A ALTAS TEMPERATURAS EN EL EXTERIOR /

CAST ALUMINIUM WITH A NON-STICK INTERIOR SURFACE AND WITH HIGH
TEMPERATURE RESISTANT PAINT ON THE OUTSIDE /

ALUMINIUM AVEC REVÊTEMENT ANTIADHÉSIF À L'INTÉRIEUR, ET
PEINTURE RÉSIDANTE AUX TEMPÉRATURES ÉLEVÉES À L'EXTÉRIEUR /

SCHMIEDEALUMINIUM MIT ANTIHAFTBESCHICHTUNG INNEN UND
HOCHTEMPERATURBESTÄNDIGER LACKIERUNG AUSSEN

FULL INDUCTION

CHAPA DE ACERO INOXIDABLE FERRÍTICO
QUE CUBRE LA TOTALIDAD DEL FONDO /

FERRITIC STAINLESS STEEL SHEET THAT
COVERS THE WHOLE OF THE BASE /

PLAQUE EN ACIER INOXYDABLE FERRITIQUE
QUI COUVRE TOUT LE FOND /

SCHICHT AUS FERRITISCHEM EDELSTAHL
DECKT DEN KOMPLETTEN BODEN AB



FONDO DIFUSOR COMPLETO QUE PERMITE UN EXCELENTE
RENDIMIENTO EN COCINAS DE INDUCCIÓN

FULL HEAT-DIFFUSING BASE WHICH OFFERS EXCELLENT
PERFORMANCE ON INDUCTION HOBS /

FOND DIFFUSEUR COMPLET OFFRANT UNE HAUTE PERFORMANCE
SUR LES CUISINIÈRES A INDUCTION /

KOMPLETTER WÄRMELEITBODEN FÜR EINE AUSGEZEICHNETE
LEISTUNG AUF INDUKTIONS-KOCHFELDERN

P170

Cacerola alta con tapa / Saucepot with lid / Braisière avec
couvercle / Hohe Kasserolle mit Deckel



REF	Ø cm	H cm	Lts	
P170.020	20	8,5	2,50	1
P170.024	24	9,0	4,00	1
P170.028	28	12,5	7,50	1

P171

Cacerola baja con tapa / Casserole with lid / Faitout avec
couvercle / Flache Kasserolle mit Deckel



REF	Ø cm	H cm	Lts	
P171.024	24	7,5	3,00	1
P171.028	28	7,5	4,50	1

P173 Cazo / Saupan / Casserole / Kasserolle



REF	Ø cm	H cm	Lts	
P173.016	16	8,4	1,50	1

VER PRODUCTOS EN / SEE PRODUCTS ON /
VOIR PRODUITS EN PAGE / SIEHE PRODUKTE IN



SARTÉN / FRY PAN / POÊLE / BRATPFANNE

Mango baquelita / Bakelite handle /
Queue en bakélite / Bakelitestiel

P. 60

MULTIMETAL



Aporta todas las ventajas del aluminio y del acero inoxidable en una sola pieza /

It gets all advantages of the aluminium and the st/steel just in one /

Apporte tous les avantages de l'aluminium et de l'acier inoxydable en une seule pièce /

Bietet alle Vorteile von Aluminium und Edelstahl in einem Einzigen Stück

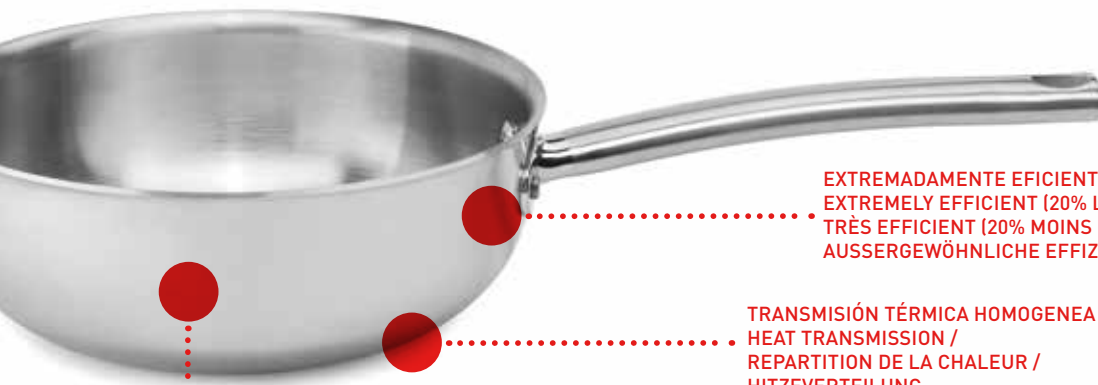

**EXTREMADAMENTE EFICIENTE (20% MENOS TIEMPO Y ENERGÍA) /
EXTREMELY EFFICIENT (20% LESS TIME AND ENERGY) /
TRÈS EFFICIENT (20% MOINS DE TEMPS ET D'ÉNERGIE) /
AUSSERGEWÖHNLICHE EFFIZIENZ (20% WENIGER ZEIT UND ENERGIE).**

**TRANSMISIÓN TÉRMICA HOMOGÉNEA /
HEAT TRANSMISSION /
REPARTITION DE LA CHALEUR /
HITZVERTEILUNG**

**PULIDO BRILLANTE / BRIGHT POLISHED /
POLISSAGE BRILLANT / GLÄNZEND POLIERT**



INOX - ST/STEEL
ROSTFREIER STAHL

MULTIMETAL

P234 Cazo bombeado / Rounded saucepan / Casserole bombée / Kugelige Stielkasserolle mit Schüttrand



REF	Ø cm	H cm	Lts	
P234.020	20	7,5	1,80	1
P234.024	24	8,5	3,00	1

VER PRODUCTOS EN / SEE PRODUCTS ON / VOIR PRODUITS EN PAGE / SIEHE PRODUKTE IN

MULTIMETAL

Woks



P. 57



2.1 ACERO INOXIDABLE / ST/STEEL / ACIER INOXYDABLE / EDELSTAHL

INOX PRO	50
IDEA	52

2.2 ALUMINIO / ALUMINIUM / ALUMINIUM / ALUMINIUM

ALU PRO INDUCTION	53
ALU PRO NO INDUCTION	54

2.3 MULTIMETAL / MULTI-PLY / MULTI-METAL / MULTIMETALL

57

2.4 ALUMINIO FUNDICIÓN / CAST ALUMINIUM / FONTE D'ALUMINIUM / ALUMINIUMGUSS

BLACK PRO	58
BLACK SOFT TOUCH	60
BLACK FIRST	60

2.5 ACERO / STEEL / ACIER / ROSTFREIER STAHL

STEEL PRO	61
STEEL CLASSIC	63

2.6 PAELLERA / SPANISH PAELLA PAN / PLAT À PAELLA / PAELLAPFANNE

64

MANGOS HANDLES MANCHES STIELE

ERGOS

MAYOR ERGONOMÍA
MORE ERGONOMIC
PLUS ERGONOMIQUE
ERGONOMISCHER



TUBULAR
TUBULAR
TUBULAIRE
RUNDGEFORMT

ESPAÑOL

Los mangos **ERGOS** de Pujadas se caracterizan por estar fabricados en tubo de acero inoxidable. Gracias a un proceso de allanado, lo convierte en un mango ergonómico y aislante del calor.

Estos mangos se presentan con dos agujeros en los dos extremos interiores, para asegurar que ninguna gota de agua quede dentro en el proceso de lavado y ésta salga en forma de vapor durante el calentamiento de la sartén.

ENGLISH

Pujadas **ERGOS** handles are characterized by being made from stainless steel tubing. Thanks to a flattening process, the tubing becomes an ergonomic and heat insulating handle.

These handles are made with two holes at the two innermost end, to ensure that no water from the washing process remains inside and comes out in the form of steam when the pan is heated.

FRANÇAIS

Les manches **ERGOS** de Pujadas se caractérisent par leur fabrication à partir d'un tube en acier inoxydable. Le processus d'aplanissement obtient un manche ergonomique doté d'une isolation thermique.

Ces manches sont présentés avec deux trous aux deux extrémités intérieures, pour qu'aucune goutte d'eau ne reste à l'intérieur pendant le processus de lavage et que celle-ci sorte sous forme de vapeur lors du chauffage de la poêle.

DEUTSCH

Die Pujadas **ERGOS** Stiele sind aus rostfreiem Edelstahl gefertigt und zeichnen sich durch eine runde Form aus. Mithilfe eines speziellen Fertigungsprozesses erhalten wir ergonomisch geformte, hitzeisolierte Stiele.

Diese Stiele sind mit zwei Öffnungen an den beiden inneren Enden ausgestattet, um sicherzustellen, dass kein Tropfen Wasser vom Spülvorgang zurückbleibt und bei Erhitzen der Pfanne verdampfen kann.

HÉRCULES

MAYOR SUJECIÓN
GREATER STRENGTH
MEILLEURE PRISE
BESSERER HALT

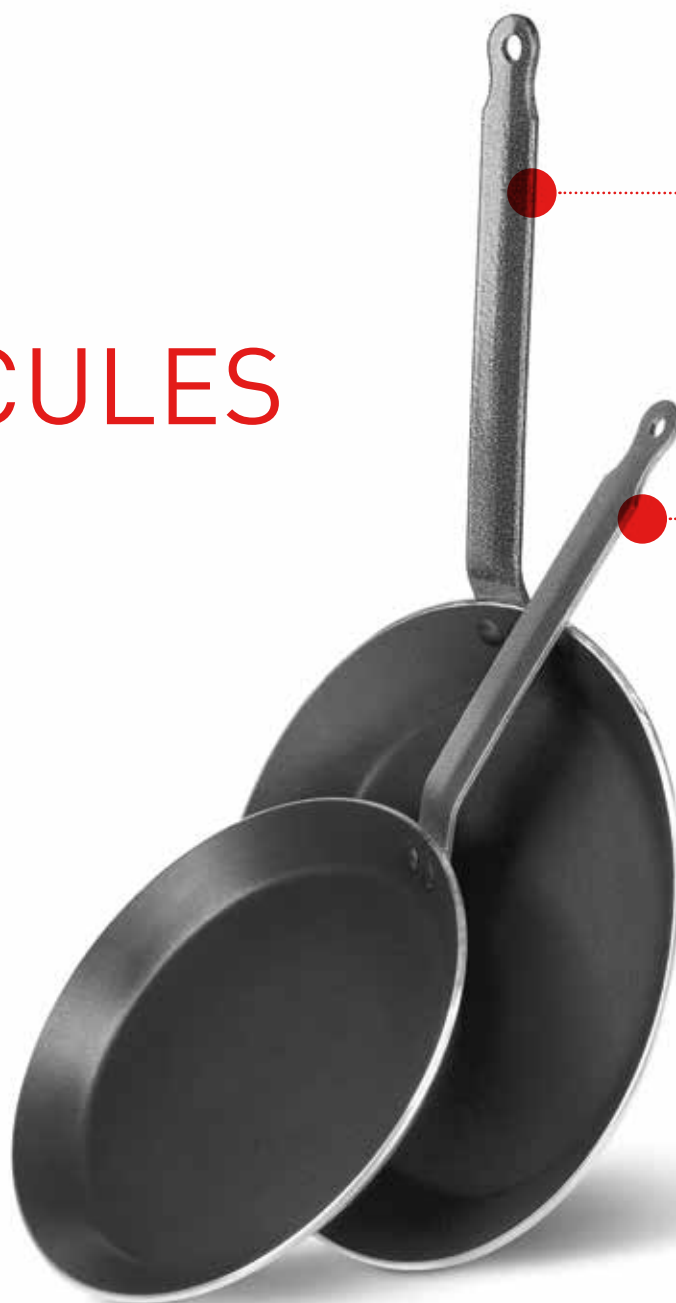

CANAL INTERIOR
INTERIOR CHANNEL
CANAL INTÉRIEUR
INNERER KANAL

BORDES PULIDOS
SMOOTHED EDGES
BORDS POLIS
GLATTE RÄNDER

ESPAÑOL

Los mangos **HÉRCULES** son aquellos fabricados en chapa plana de hierro recubiertos con una pintura protectora resistente a altas temperaturas, que evita una rápida oxidación. Esta chapa se presenta con los bordes pulidos y con una ligera canal en medio para una mejor sujeción.

FRANÇAIS

Les manches **HÉRCULES** sont fabriqués en plaque de fer plate et recouverts d'une peinture protectrice résistante aux températures élevées, qui évite une oxydation rapide. Cette plaque est dotée de bords polis et d'un léger canal au milieu pour une meilleure prise.



ENGLISH

HÉRCULES handles are made of flat iron sheet coated with a high temperature resistant protective paint, which prevents rapid oxidation. The handles have smoothed edges and a slight channel in the centre for increased strength.

DEUTSCH

Die **HÉRCULES** Stiele werden aus einem flachen Eisenblech gefertigt, das von einer hochtemperaturbeständigen Schutzlackierung, die ein schnelles Verrosten verhindert, umhüllt ist. Dieses Eisenblech weist glatte Ränder und einen kleinen Kanal in der Mitte für einen besseren Halt auf.

GUÍA DE SELECCIÓN SARTENES / FRY PANS SELECTION GUIDE /
GUIDE DE SÉLECTION POÊLES / AUSWAHLÜBERSICHT BRATPFANNEN

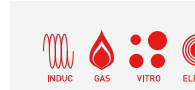













	ACERO INOXIDABLE / STAINLESS STEEL / ACIER INOXYDABLE / ROSTFREIER STAHL			ALUMINIO / ALUMINIUM / ALUMINIUM / ALUMINIUM	
	INOX PRO	INOX CERAMIC	IDEA	ALU PRO INDUCTION	ALU PRO
REF / ITEM / CODE / ART.NR.					
COMPATIBLE CON / COMPATIBLE WITH / COMPATIBLE AVEC / GEEIGNET FÜR					
PRECIO / PRICE / PRIX / PREIS	€€	€€	€€	€	€
ESPESOR / THICKNESS / EPAISSEUR / DICKE	0,8 mm	0,8 mm	0,7 mm	4 mm	4,5 mm
ANTIADHERENTE / COATING / REVÊTEMENT / ANTIHAFTBESCHICHTUNG					
MANGO / HANDLE / QUEUE / GRIFF	INOXIDABLE / ST/STEEL / INOXYDABLE / ROSTFREI	INOXIDABLE / ST/STEEL / INOXYDABLE / ROSTFREI	INOXIDABLE / ST/STEEL / INOXYDABLE / ROSTFREI	INOXIDABLE / ST/STEEL / INOXYDABLE / ROSTFREI	INOXIDABLE / ST/STEEL / INOXYDABLE / ROSTFREI
RECOMENDADA / RECOMMENDED / RECOMMANDÉE / EMPFEHLUNG	ALTA RESISTENCIA A LA ABRASIÓN / HIGH RESISTANCE TO ABRASION / HAUTE RÉSIDENCE À L'ABRASION / HOHE RESISTENZ GEGEN VERSCHLEISS	ALTA RESISTENCIA A LA ABRASIÓN / HIGH RESISTANCE TO ABRASION / HAUTE RÉSIDENCE À L'ABRASION / HOHE RESISTENZ GEGEN VERSCHLEISS	RESISTENCIA PROFESIONAL / PROFESSIONAL STRENGTH / DURETÉ PROFESSIONNEL / PROFESSIONNELLE RESISTENZ	ALTA RESISTENCIA A LA ABRASIÓN / HIGH RESISTANCE TO ABRASION / HAUTE RÉSIDENCE À L'ABRASION / HOHE RESISTENZ GEGEN VERSCHLEISS	COCCIÓN A FUEGO LENTO / SLOW BAKING / CUISSON À FEU LENT / KOCHEN MIT KLEINER FLAMME

INDUCCIÓN /
INDUCTION /
INDUCTION /
INDUKTION

NO INDUCCIÓN /
NO INDUCTION /
NON INDUCTION /
NICHT INDUKTION

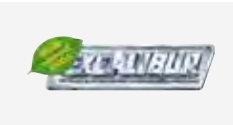
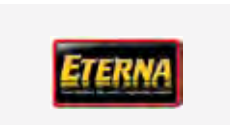
PROFESIONAL / PROFESSIONAL /
PROFESSIONNEL / PROFESSIONELL

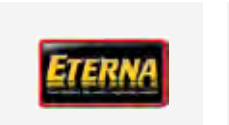
SARTENES /
FRY PANS /
POÊLES

MULTIMETAL / MULTI-PLY / MULTI-METAL / MULTIMETALL	ALUMINIO FUNDICIÓN / CAST ALUMINIUM / FONTE D'ALUMINIUM / ALUMINIUMGUSS			ACERO / STEEL / ACIER / STAHL	
MULTIMETAL	BLACK PRO	BLACK SOFT TOUCH	BLACK FIRST	STEEL PRO	STEEL CLASSIC
					
					
€€€€	€€	€€	€€	€€	€
3,5 mm	4 mm	3 mm	4 mm	2 mm	1,5 mm
					NINGUNO / NONE / AUCUN / KEINE
INOXIDABLE / ST/STEEL / INOXYDABLE / ROSTFREI	INOXIDABLE / ST/STEEL / INOXYDABLE / ROSTFREI	BAQUELITA / BAKELITE / BAKELIT (MAX. TEMP. 160 °C)	MADERA / WOODEN / BOIS / HOLZ	INOXIDABLE / ST/STEEL / INOXYDABLE / ROSTFREI	HIERRO / FLAT IRON / FER / EISEN
HOMOGENEIDAD Y EFICACIA TÉRMICA / HOMOGENEITY AND THERMAL EFFECTIVENESS / HOMOGÉNITÉ ET EFFICACITÉ THERMIQUE / HOMOGENITÄT UND WÄRMEFFIZIENZ	ROBUSTEZ Y BUEN DESGLIZAMIENTO / ROBUSTNESS AND GOOD SLIDING / ROBUSTESSE ET BON GLISSEMENT / ROBUSTHEIT UND GUTES RUTSCHEN	ROBUSTEZ Y EFICIENCIA / ROBUSTNESS AND EFFICIENCY / ROBUSTESSE ET EFFICACITÉ / ROBUSTHEIT UND EFFIZIENZ	ROBUSTEZ Y BUEN DESGLIZAMIENTO / ROBUSTNESS AND GOOD SLIDING / ROBUSTESSE ET BON GLISSEMENT / ROBUSTHEIT UND GUTES RUTSCHEN	ALTAS TEMPERATURAS / HIGH TEMPERATURES HAUTES TEMPERATURES / HOHE TEMPERATUREN	SELLAR, FREIR, DORAR / SEALING, FRYING, BROWNING / CULOTTAGE, FRIRE ET DORER / ANBRATEN, FRITIEREN, ANBRÄUNEN



INOX PRO

INDUCCIÓN / INDUCTION



P220 Sartén antiadherente excalibur "ERGOS" / Non-stick "ERGOS" excalibur fry pan / Poêle anti-adhésive excalibur "ERGOS" / Bratpfanne Antihaft excalibur "ERGOS"



CLASS
INDUCTION

Fondo sandwich
Sandwich bottom
Fond sandwich
Sandwichboden



REF	Ø cm	H cm	
P220.018	18	3,5	1
P220.020	20	3,8	1
P220.022	22	4,2	1
P220.024	24	4,6	1
P220.026	26	5,0	1
P220.028	28	5,5	1
P220.032	32	6,0	1
P220.036	36	6,0	1
P220.040	40	6,5	1

ANTIADHERENTE / NON-STICK COATING /
ANTI-ADHÉSIF / ANTIHAFTBESCHICHTUNG

DETALLE TRATAMIENTO ANTIADHERENTE / NON-STICK COATING TREATMENT / DÉTAIL APPLICATION ANTI-ADHÉSIF / BEHANDLUNG MIT ANTIHAFTBESCHICHTUNG



Para dar rugosidad a la superficie de la pieza se chorrea con elementos abrasivos y con ello se logra un buen anclaje del excalibur.

The surface of the substrate is blasted with an abrasive to roughen it, so other elements in the excalibur process adhere to it better.

Afin de la rendre rugueuse, la surface de la pièce est sablée avec un abrasif; ceci permettra une excellente tenue du procédé excalibur.

Um der Oberfläche eine Rauheit zu geben wird sie mit rauen Elementen bestrahlt. Dies erlaubt einen exzellenten Halt von anderen Elementen im Excalibur Prozess.



La parte más importante del proceso: la pulverización y deposición de las partículas fundidas de una aleación de acero inoxidable, patentada por whitford.

Then, the most important part: white-hot particles of a special stainless steel (whitford's patented alloy) are sprayed onto the roughened surface.

Le processus plus important: des particules d'un acier inoxydable spécial (protégé par brevet par whitford) sont chauffées à blanc et pulvérisées sur la pièce.

Der wichtigste Prozessschritt: Die Pulverisierung und Ablagerung der Schmelzpartikel formt sich zu einer speziellen Legierung (whitford Legierung patentiert).



Las partículas se enfrían, formando parte integral de la superficie con "picos" y "valles" que permiten alojar las capas de antiadherente de forma permanente.

The particles cool and harden, bonded to the surface, forming a series of "peaks and valleys" that provide a permanent base for the non-stick coatings.

Ces particules se refroidissent, forment des crêtes et des vallées constituant une excellente base permanente d'accrochage et de renforcement de l'anti-adhésif.

Die Partikel kühlen sich ab und integrieren sich in der Oberfläche in Form von "Höhen und Tiefen". Dies ermöglicht eine permanente Grundlage für die Antihaftbeschichtung.



Finalmente se aplican varias capas de fluoropolímeros que rellenan los "valles" y cubren los "picos", los cuales protegen el recubrimiento antiadherente.

Several coats of tough fluoropolymers fill the "valleys" and cover the "peaks", held permanently in place by the special stainless steel "peaks".

Des couches d'anti-adhésif très résistant sont appliquées; elles remplissent les vallées, recouvrent juste le haut des crêtes qui les maintiennent fermement en place.

Schliesslich werden unterschiedliche Schichten aus Fluorpolymer über die "Höhen und Tiefen" aufgetragen, um die Antihaftbeschichtung zu schützen.

COOL • LINE COLORS



VER PRODUCTOS EN / SEE PRODUCTS ON /
VOIR PRODUITS EN PAGE / SIEHE PRODUKTE IN
P. 408

INOX PRO INTENSIVE

INDUCCIÓN / INDUCTION

P2208 Sartén antiadherente cerámico / Fry pan with ceramic non-stick coating /
Poêle revêtement anti-adhésif céramique / Bratpfanne keramische Antihftbeschichtung



CLASS
INDUCTION



REF	Ø cm	H cm	
P220.820	20	3,8	1
P220.824	24	4,6	1
P220.828	28	5,5	1
P220.832	32	6,0	1

ANTIADHERENTE /
NON-STICK COATING /
ANTI-ADHÉSIF /
ANTIHAFTBESCHICHTUNG



EXPERT

P213 Sartén "EXPERT" / "EXPERT" fry pan / Poêle "EXPERT" / Bratpfanne "EXPERT"



CLASS
INDUCTION

Fondo sandwich
Sandwich base
Fond sandwich
Sandwichboden



REF	Ø cm	H cm	
P213.018	18	3,5	1
P213.020	20	3,8	1
P213.022	22	4,2	1
P213.024	24	4,6	1
P213.026	26	5,0	1
P213.028	28	5,5	1
P213.032	32	6,0	1
P213.036	36	6,0	1
P213.040	40	6,5	1

P2393 Wok fondo redondo / Round base wok / Wok à fond rond / Wok mit rundem Boden



CLASS
INDUCTION



REF	Ø cm	H cm	Lts	
P239.336	36	10,0	6,00	1

P2392 Wok fondo plano / Flat base wok / Wok à fond plain / Wok mit flachem Boden



CLASS
INDUCTION



REF	Ø cm	H cm	Lts	
P239.236	36	9,0	5,50	1

IDEA

INDUCCIÓN / INDUCTION

P459 Sartén / Fry pan / Poêle / Bratpfanne



IDEA
COLLECTION
P. 34



REF	Ø cm	H cm	
P459.020	20	4,5	1
P459.024	24	5,0	1
P459.028	28	5,5	1

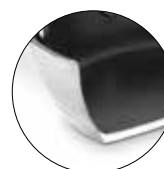

ALL
OVER
TECH





ALU PRO

INDUCCIÓN / INDUCTION

P1289 Sartén antiadherente fondo inducción "HERCULES" / Non-stick induction fry pan "HERCULES" / Poêle anti-adhésive fond induction "HERCULES" / Bratpfanne Antihaft Induktion "HERCULES"



ANTIADHERENTE / NON-STICK COATING /
ANTI-ADHÉSIF / ANTIHAFTBESCHICHTUNG



REF	Ø cm	H cm	
P128.920	20	4,0	12
P128.924	24	4,5	6
P128.928	28	5,0	6
P128.932	32	5,5	6



Fondo chapa inox. inducción
St/Steel sheet induction bottom
Fond plaque inox. induction
Rostfreier Stahlblechunterboden Induktion

P1209 Sartén antiadherente fondo inducción "ERGOS" / Non-stick induction fry pan "ERGOS" / Poêle anti-adhésive fond induction "ERGOS" / Bratpfanne Antihaft Induktion "ERGOS"



ANTIADHERENTE / NON-STICK COATING /
ANTI-ADHÉSIF / ANTIHAFTBESCHICHTUNG



REF	Ø cm	H cm	
P120.920	20	4,0	12
P120.924	24	4,5	6
P120.928	28	5,0	6
P120.932	32	5,5	6



Fondo chapa inox. inducción
St/Steel sheet induction bottom
Fond plaque inox. induction
Rostfreier Stahlblechunterboden Induktion

P1208 Sartén con antiadherente cerámico / Fry pan with ceramic non-stick coating / Poêle à revêtement anti-adhésif céramique / Bratpfanne mit keramischer Antihaftbeschichtung



REF	Ø cm	H cm	
P120.820	20	4,0	12
P120.824	24	4,5	6
P120.828	28	5,0	6
P120.832	32	5,5	6



Fondo chapa inox. inducción
St/Steel sheet induction bottom
Fond plaque inox. induction
Rostfreier Stahlblechunterboden Induktion

ALU PRO

NO INDUCCIÓN / NO INDUCTION



ESPAÑOL

Fabricadas en aluminio con recubrimiento antiadherente, adaptadas a todo tipo de cocinas excepto inducción. No aptas para hornos.

ENGLISH

Made of aluminium with non-stick coating, suitable for any kind of stove except induction and oven.

FRANÇAIS

Fabriquées en aluminium avec revêtement anti-adhésif, recommandées pour tout type de feux, sauf induction. Ne pas utiliser aux fours.

DEUTSCH

Herstellung aus Aluminium mit Antihftbeschichtung, Angepasst an Alle Kocharten Ausschliesslich Induktion und Ofen.

P120 Sartén antiadherente "ERGOS" / Non-stick fry pan "ERGOS" / Poêle anti-adhésive "ERGOS" / Antihft Bratpfanne "ERGOS"



Fácil limpieza / Easy to clean /
Facile à nettoyer / Einfaches Reinigen



Fondo plano
Plain base
Fond plain
Glatter Unterboden

REF	Ø cm	H cm	
P120.018	18	4,0	12
P120.020	20	4,0	12
P120.022	22	4,5	12
P120.024	24	4,5	6
P120.026	26	5,0	6
P120.028	28	5,0	6
P120.032	32	5,5	6
P120.036	36	6,0	6
P120.040	40	6,5	6

P128 Sartén antiadherente "HERCULES" / Non-stick fry pan "HERCULES" / Poêle anti-adhésive "HERCULES" / Antihft Bratpfanne "HERCULES"



Fácil limpieza / Easy to clean /
Facile à nettoyer / Einfaches Reinigen



Fondo plano
Plain base
Fond plain
Glatter Unterboden

REF	Ø cm	H cm	
P128.018	18	4,0	12
P128.020	20	4,0	12
P128.022	22	4,5	12
P128.024	24	4,5	6
P128.026	26	5,0	6
P128.028	28	5,0	6
P128.032	32	5,5	6
P128.036	36	6,0	6
P128.040	40	6,5	6

P128 Sartén antiadherente "HERCULES" mango colores / Non-stick FRY PAN "HERCULES" Coloured handles / Poêle anti-adhésif "HERCULES" Queue à couleurs / Antihft Braffpfanne "HERCULES" farbige Griffe



REF	ROJO/RED/ ROUGE/ROT	AMARILLO/YELLOW/ JAUNE/GELB	AZUL/BLUE/ BLEU/BLAU	VERDE/GREEN/ VERT/GRÜN	Ø cm	H cm	
P128	1	2	3	4	20	4,0	12
P128	1	2	3	4	24	4,5	12
P128	1	2	3	4	28	5,0	12
P128	1	2	3	4	32	5,5	6

- Carnes rojas / Red meat / Viande rouge / Rotes Fleisch
- Carnes blancas y huevos / White meat and eggs / Volaille et oeufs / Weisses Fleisch und Eier
- Pescado / Fish / Poisson / Fisch
- Verdura / Vegetables / Legumes / Gemüse

Ref: P128 + [Color / Colour / Couleur / Farbe] + Ø

ALU PRO SPECIAL

NO INDUCCIÓN / NO INDUCTION

P127 Sartén "ERGOS" expert / Fry pan "ERGOS" expert / Poêle "ERGOS" expert / Bratpfanne "ERGOS" Expert



REF	Ø cm	H cm	
P127.024	24	4,5	1
P127.028	28	5,0	1
P127.032	32	5,5	1
P127.036	36	6,0	1
P127.040	40	6,5	1

P148 Sartén honda "ERGOS" antiadherente / Non-stick sauté pan "ERGOS" / Sauteuse évasée en anti-adhésive "ERGOS" / Antihaft tiefe Bratpfanne "ERGOS"



REF	Ø cm	H cm	
P148.020	20	6,5	1
P148.024	24	7,0	1
P148.028	28	7,5	1
P148.032	32	8,0	1

P124 Paellera antiadherente / Non-stick paella pan / Plat à paella anti-adhésif / Paellapfanne Antihaft



REF	Ø cm	H cm	
P124.020	20	4,0	1
P124.024	24	4,5	1
P124.028	28	5,0	1
P124.032	32	5,5	1
P124.036	36	6,0	1
P124.040	40	6,5	1

Asas de acero inox / St/Steel handle /
Anses en acier inox / Griffe aus rostfreiem Stahl

P125 Sartén pescado "ERGOS" antiadherente / Non-stick FRY pan for fish "ERGOS" / Poêle à poisson "ERGOS" anti-adhésive / Antihaft Fischbratpfanne "ERGOS"



REF	Ø cm	H cm	
P125.038	38 x 26	5,0	1

ALU PRO SPECIAL

NO INDUCCIÓN / NO INDUCTION

Sartén para crêpes "HERCULES" antiadherente /
Non-stick crêpe fry pan "HERCULES" /
Poêle à crêpes "HERCULES" anti-adhésive /
Crêpepfanne "HERCULES" Antihaft

P131



REF	Ø cm	H cm	
P131.022	22	2,5	12
P131.026	26	2,5	12

Sartén para blinis antiadherente /
Non-stick blinis fry pan /
Poêle à blinis anti-adhésive /
Bratpfanne für Blinis Antihaft

P139



IDEA!

Especial para huevo frito /
Specially for fried egg /
Spécialement pour œuf frit /
Speziell für Spiegeleier

REF	Ø cm	H cm	
P139.012	12	2,0	36

V I O L E T

C O L L E C T I O N

NO INDUCCIÓN / NO INDUCTION

ANTIALÉRGICO /
ALLERGEN-FREE /
ANTI ALLERGIQUE /
ANTI ALLERGIE

PREPARE Y SIRVA COMIDAS QUE NO CONTENGAN ALÉRGENOS /
PREPARE AND SERVE ALLERGEN-FREE FOODS /
PREPAREZ ET SERVEZ DES PLATS SANS ALLERGÈNES /
MAHLZEITEN ZUBEREITEN UND SERVIEREN OHNE ALLERGENE

P1201 Sartén antiadherente / Non-stick fry pan /
Poêle anti-adhésive / Antihaft Bratpfanne



EXCLUSIVE



+ VIOLET
COLLECTION
P. 30, 104

REF	Ø cm	H cm	
P120.120	20	4,0	1
P120.124	24	4,5	1
P120.128	28	5,0	1

EASY APOLO

NO INDUCCIÓN / NO INDUCTION

P460 Sartén aluminio antiadherente. Mango baquelita / Aluminium non-stick fry pan. Bakelite handle /
Poêle aluminium anti-adhésive. Queue en bakélite / Aluminiumbratpfanne Antihaft. Bakelitestiel



REF	Ø cm	H cm	
P460.018	18	4,0	12
P460.020	20	4,0	12
P460.022	22	4,0	12
P460.024	24	4,0	12
P460.026	26	4,5	12
P460.028	28	4,5	12
P460.030	30	4,5	12
P460.032	32	5,0	12

MULTIMETAL

INDUCCIÓN / INDUCTION

Aporta todas las ventajas del aluminio y del acero inoxidable en una sola pieza /

It gets all advantages of the aluminium and the st/steel just in one /

Apporte tous les avantages de l'aluminium et de l'acier inoxydable en une seule pièce /

Bietet alle Vorteile von Aluminium und Edelstahl in einem Einzigen Stück



P2390 / P2394 Wok fondo redondo / Round base wok / Wok à fond rond / Wok runder Boden



REF. P239.436*



REF. P239.036

REF	Ø cm	H cm	Lts	
P239.036	36	10,0	6,00	1
P239.436*	36	10,0	6,00	1

*ANTIADHERENTE / NON-STICK COATING /
ANTI-ADHÉSIF / ANTIHAFTBESCHICHTUNG



P2391 / P2395 Wok fondo plano / Flat base wok / Wok à fond plain / Wok ebener Boden



REF. P239.536*



REF. P239.136

REF	Ø cm	H cm	Lts	
P239.136	36	9,0	5,50	1
P239.536*	36	9,0	5,50	1

*ANTIADHERENTE / NON-STICK COATING /
ANTI-ADHÉSIF / ANTIHAFTBESCHICHTUNG



VER PRODUCTOS EN / SEE PRODUCTS ON / VOIR PRODUITS EN PAGE / SIEHE PRODUKTE IN

PLACA DE INDUCCIÓN WOK /
WOK INDUCTION COOKER /
PLAQUE À INDUCTION WOK /
INDUKTIONSKOCHFELD WOK

P. 287



BLACK PRO

INDUCCIÓN / INDUCTION



FABRICADA EN ALUMINIO DE FUNDICIÓN DE GRAN RESISTENCIA A LA DEFORMACIÓN Y CON EXCELENTES PRESTACIONES TÉRMICAS /
MANUFACTURED IN CAST ALUMINIUM WITH EXCELLENT RESISTANCE TO DEFORMATION AND WITH EXCELLENT THERMAL PROPERTIES /
FABRIQUÉE EN FONTE D'ALUMINIUM TRÈS RÉSISTANTE À LA DÉFORMATION ET DOTÉE D'EXCELLENTE PERFORMANCES TECHNIQUES /
AUS ALUGUSS VON HOHER FORMBESTÄNDIGKEIT UND MIT AUSGEZEICHNETER WÄRMELEITFÄHIGKEIT

MANGO TUBULAR DE ACERO INOXIDABLE /
TUBULAR STAINLESS STEEL HANDLE /
MANCHE TUBULAIRE EN ACIER INOXYDABLE /
RUNDGRIFF AUS EDELSTAHL

ANTIADHERENTE ETERNA DE ALTA RESISTENCIA /
HIGHLY RESISTANT ETERNA NON-STICK SURFACE /
ANTIADHESIF PERMANENT TRÈS RESISTANT /
HOCHBESTÄNDIGE PERMANENTE ANTIHAFTBESCHICHTUNG



P1491 Sartén mango inox / Fry pan st/steel handle / Poêle manche inox / Bratpfanne Edelstahlgriff



REF	Ø cm	H cm	
P149.120	20	5,0	4
P149.124	24	5,0	4
P149.128	28	5,0	4
P149.130	30	5,0	4

P1492 Sartén honda mango inox / Deep fry pan st/steel handle / Poêle haute manche inox / Hohe Bratpfanne Edelstahlgriff



REF	Ø cm	H cm	
P149.228	28	7,5	4

P1493 Wok mango inox / Wok st/steel handle /
Wok manche inox / Wok Edelstahlgriff



REF	Ø cm	H cm	
P149.330	30	9,5	4

P1501 Sartén crêpes mango inox / Crêpe fry pan st/steel handle /
Poêle à crêpes manche inox / Crêpepfanne Edelstahlgriff



REF	Ø cm	H cm	
P150.128	28	1,5	4

P1421 Asador grill mango inox / Grill st/steel handle /
Grill manche inox / Grillpfanne Edelstahlgriff



REF	Ø cm	H cm	
P142.100	28 x 28	4,0	1

VER PRODUCTOS EN / SEE PRODUCTS ON / VOIR PRODUITS EN PAGE / SIEHE PRODUKTE IN

CAZUELA /
CASSEROLE /
BRAISIÈRE /
KASSEROLLE

P. 41





BLACK FORGED SOFT TOUCH

INDUCCIÓN / INDUCTION



N

FULL INDUCTION

Fondo inducción completo /
Full induction base /
Fond à induction complet /
Kompletter Induktionsboden

Sartén fabricada en aluminio forjado de alta resistencia que ofrece una gran eficiencia energética gracias a su fondo inducción completo con mango de baquelita soft touch resistente a una temperatura máxima de 160 °C /

Poêle fabriquée en aluminium revêtu très résistant, offrant une grande efficacité énergétique, grâce à son fond à induction complet avec manche en bakélite soft touch résistant à une température maximale de 160°C /

Frying pan manufactured in high-resistance forged aluminium which offers excellent energy efficiency thanks to its full induction base with a soft-touch bakelite handle, resistant to temperatures up to 160 °C /

Pfanne aus Schmiedealuminium von hoher Beständigkeit bietet dank ihres kompletten Induktionsbodens eine hohe Energieeffizienz, mit Bakelit Soft-Touch-Griff beständig bis zu einer Temperatur von maximal 160 °C

P1495 Sartén aluminio forjado / Forged aluminium frying pan / Poêle en aluminium revêtu / Schmiedealu-Pfanne



FULL INDUCTION



REF	Ø cm	H cm	
P149.520	20	5,0	1
P149.524	24	5,5	1
P149.528	28	6,0	1

BLACK FIRST

NO INDUCCIÓN / NO INDUCTION

P150 Sartén crêpes mango baquelita / Crêpe fry pan bakelite handle / Poêle à crêpes manche bakélite / Crêpepfanne mit Bakelitstiel



Aluminio de fundición /
Cast aluminium /
Fonte d'aluminium /
aluminiumGuss



REF	Ø cm	H cm	
P150.028	28	2,0	12



P142 Asador grill mango madera / Grill wooden handle / Grill queue en bois / Grillpfanne mit Holzstiel



Aluminio de fundición /
Cast aluminium /
Fonte d'aluminium /
aluminiumGuss



REF	cm	H cm	
P142.000	29x29	4,3	5



STEEL PRO 1921 SERIES

INDUCCIÓN / INDUCTION



SARTÉN DE ACERO DE FUNDICIÓN LIGERO DE FÁCIL MANEJO /
LIGHT CAST STEEL FRY PAN EASY TO USE /
POÊLE EN FONTE D'ACIER LÉGER, FACILE À MANIPULER /
BRATPFANNE AUS LEICHTEM GUSSEISEN FÜR EINE EINFACHE HANDHABUNG

40%

MENOS DE PESO QUE LAS SARTENES DE HIERRO TRADICIONAL /
LESS WEIGHT THAN TRADITIONAL IRON PANS /
DE POIDS EN MOINS PAR RAPPORT AUX POÊLES EN FER TRADITIONNELLES /
WENIGER GEWICHT ALS DIE TRADITIONELLEN EISENBRATPFANNEN

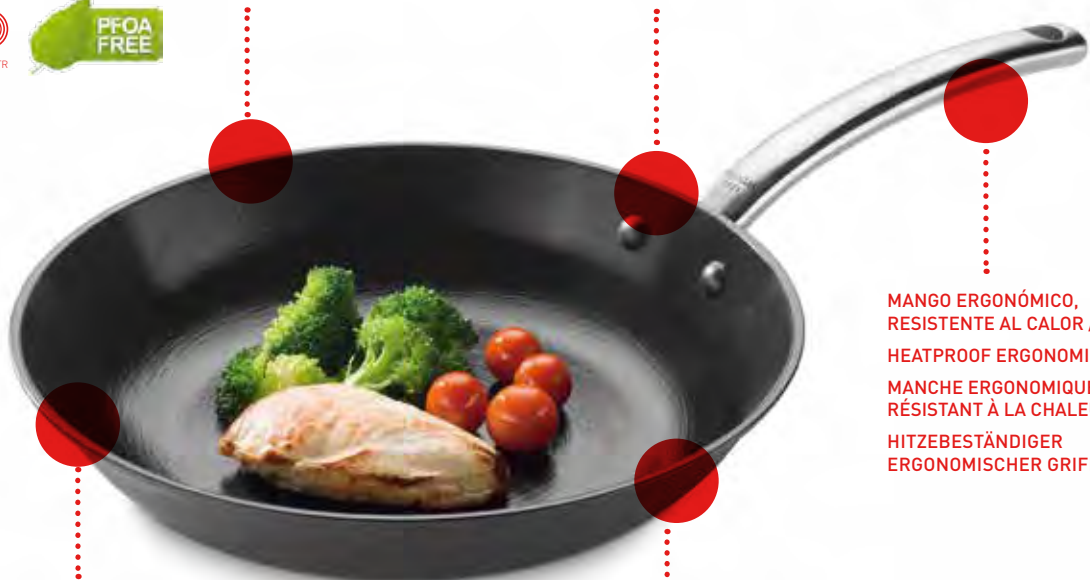

MANGO ERGONÓMICO,
RESISTENTE AL CALOR /
HEATPROOF ERGONOMIC HANDLE /
MANCHE ERGONOMIQUE,
RÉSISTANT À LA CHALEUR /
HITZEBESTÄNDIGER
ERGONOMISCHER GRIFF

EXTRAORDINARIAS PROPIEDADES CALÓRICAS.
EXCELENTE Y HOMOGÉNEA DISTRIBUCIÓN DEL CALOR /

EXTRAORDINARY CALORIC PROPERTIES. EXCELLENT
AND UNIFORM HEAT DISTRIBUTION /

PROPRIÉTÉS CALORIQUES EXTRAORDINAIRES.
EXCELLENT ET HOMOGÈNE DISTRIBUTION DE LA CHALEUR /

AUSSERGEWÖHNLICHE KALORISCHE EIGENSCHAFTEN
EXZELLEENTE UND GLEICHMÄSSIGE HITZEVERTEILUNG

TRES CAPAS DE ANTIADHERENTE DE ÚLTIMA GENERACIÓN, LIBRE DE PFOA /
LAST GENERATION THREE LAYERS NON-STICK COATING. PFOA FREE /
TROIS COUCHE ANTI-ADHÉSIVE DE DENIÈRE GÉNÉRATION. LIVRE DE PFOA /
DREIFACHE ANTIHAFTBESCHICHTUNG DER NEUESTEN GENERATIONEN. PFOA FREI

IDEA!

Para una cocina rápida y sana, permite cocinar carnes, pescados y verduras a fuego alto, usando muy poco aceite /

For a quick and healthy cooking, it enables you to cook meats, fish, vegetables using high heat and very little oil /

Pour une cuisine rapide et saine, permettant de cuisiner les viandes, poissons et légumes à feu vif, en utilisant très peu d'huile /

Für eine schnelle und gesunde Küche, erlaubt Fleisch, Fisch und Gemüse auf hoher Flamme mit wenig Öl zu braten

P169 Sartén / Fry pan / Poêle / Bratpfanne



REF	Ø cm	H cm	
P169.020	20	20	1
P169.024	24	24	1
P169.028	28	28	1
P169.030	30	30	1

ANTIADHERENTE / NON-STICK COATING /
ANTI-ADHÉSIF / ANTIHAFTBESCHICHTUNG



P166 Wok con tapa / Wok with lid / Wok avec couvercle / Wok mit Deckel



REF	Ø cm	H cm	Lts	
P166.032	32	8,0	4,40	1

ANTIADHERENTE / NON-STICK COATING /
ANTI-ADHÉSIF / ANTIHAFTBESCHICHTUNG



Tapa de cristal incluida /
Glass lid included /
Couvercle en verre inclus /
Glasdeckel inklusive



STEEL CLASSIC

INDUCCIÓN / INDUCTION



EXCELENTES PROPIEDADES TÉRMICAS Y
ANTIADHERENTES NATURALES /
EXCELLENT THERMAL AND NATURAL
NONSTICK PROPERTIES /
EXCELLENTE PROPRIÉTÉS THERMIQUES ET
ANTIADHÉSIVES NATURELLES /
AUSGEZEICHNETE WÄRMELEIT- UND
NATÜRLICHE ANTIHAFTFÄHIGKEIT

MANGO HÉRCULES /
HERCULES LONG HANDLE /
MANCHE HERCULES /
HÉRCULES-STIEL

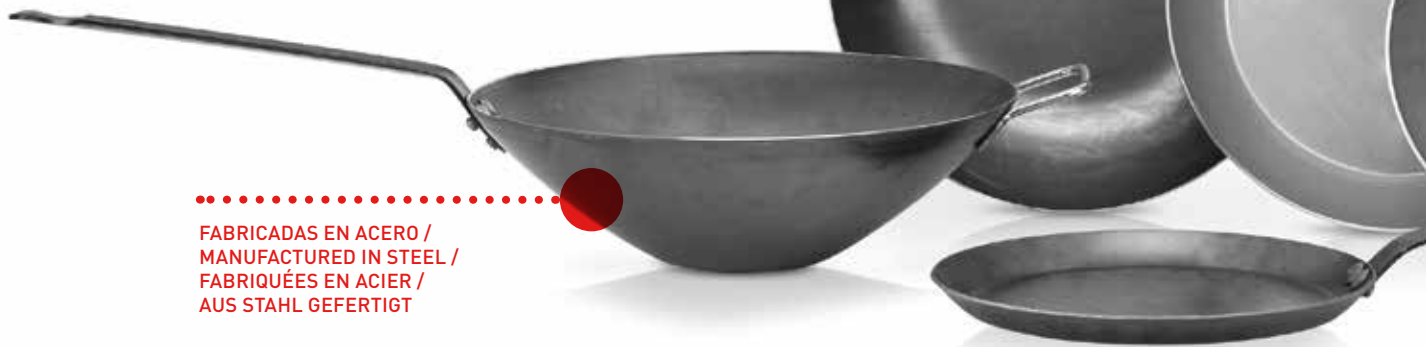

FABRICADAS EN ACERO /
MANUFACTURED IN STEEL /
FABRIQUÉES EN ACIER /
AUS STAHL GEFERTIGT

P1351 Sartén "Lionesa" 1,5 mm / "Lyonnaise" Steel fry pan 1,5 mm / Poêle "Lyonnaise" 1,5 mm / Bratpfanne "Lyoner" 1,5 mm



REF	Ø cm	H cm	
P135.120	20	4,5	1
P135.124	24	5,0	1
P135.128	28	5,5	1
P135.132	32	6,0	1
P135.136	36	6,5	1
P135.140	40	7,0	1

P1353 Wok / Wok / Wok / Wok



REF	Ø cm	H cm	
P135.330	30	9,5	1

P1354 Sartén para crêpes / Crêpe fry pan / Poêle à crêpes / Crêpesbratpfanne



REF	Ø cm	H cm	
P135.424	24	2,0	1

ACERO / STEEL / ACIER / STAHL



INDUCCIÓN / INDUCTION

P994 Paellera valenciana en acero pulido / Black steel spanish paella pan /
Plat à paella tôle acier / Spanische Paellapfanne aus poliertem Stahl



REF	Ø cm	RACIONES / PORTIONS / PORTIONEN	
P994.020	20	1	1
P994.022	22	1	1
P994.024	24	1	1
P994.026	26	2	1
P994.030	30	4	1
P994.032	32	5	1
P994.034	34	6	1
P994.036	36	7	1
P994.038	38	8	1
P994.040	40	9	1
P994.042	42	10	1
P994.046	46	12	1
P994.050	50	14	1
P994.055	55	16	1
P994.065	65	22	1
P994.080	80	40	1
P994.090	90	50	1

ACERO ESMALTADO / ENAMELLED STEEL ACIER ÉMAILLÉ / EMAILLIERTE STAHL

P995 Paellera acero esmaltado / Enamelled steel paella pan /
Plat à paella acier émaillé / Paellapfanne aus emailliertem Stahl



*MINI-SIZE

IDEA!

Ideal para tapas
Recommended for snacks
Recommandé pour tapas
Ideal für Snacks

REF	Ø cm	RACIONES / PORTIONS / PORTIONEN	
P995.010 *	10	-	1
P995.016 *	15	-	1
P995.020	20	2	1
P995.026	26	2	1
P995.030	30	4	1
P995.034	34	6	1
P995.036	36	7	1
P995.038	38	8	1
P995.040	40	9	1
P995.042	42	10	1
P995.050	50	14	1
P995.060	60	19	1

P997 Sartén honda esmaltada con asas / Deep enamelled fry pan with handles /
Poêle haute avec anses / Tiefe Paellapfanne aus emailliertem Stahl mit Griffen



*MINI-SIZE

IDEA!

Ideal para tapas
Recommended for snacks
Recommandé pour tapas
Ideal für Snacks

REF	Ø cm	Lts	
P997.014 *	14	0,40	1
P997.016 *	16	0,50	1
P997.028	28	3,90	1
P997.032	32	5,30	1
P997.036	36	7,80	1
P997.040	40	9,40	1

PAELLEROS / BURNERS

NO INDUCCIÓN / NO INDUCTION

P998 Paellero esmaltado gas / Enamelled gas burner / Brûleur émaillé / Emailierter Gasbrenner



REF	Ø cm	CIRCULOS / CIRCLES / CERCLES / KREIS	Kw	
P998.035	35	2	9,4	1
P998.050	50	2	14,1	1
P998.070	70	3	24,1	1

Válido para gas butano y propano NO para gas ciudad
Valid only for gas butane and propane
Valable uniquement pour gaz butane et propane /
Geeignet nur für Butan- und Propangas

Ref. P998.035
Para paelleras de 20 a 50 cm Ø
For paella pans from Ø 20 to 50 cm
Pour plats à paella de 20 à 50 cm Ø
Für Paellapfannen von 20 bis 50 cm Ø

Ref. P998.050
Para paelleras de 36 a 70 cm Ø
For paella pans from Ø 36 to 70 cm
Pour plats à paella de 36 à 70 cm Ø
Für Paellapfannen von 36 bis 70 cm Ø

Ref. P998.070
Para paelleras de 36 a 90 cm Ø
For paella pans from Ø 36 to 90 cm
Pour plats à paella de 36 à 90 cm Ø
Für Paellapfannen von 36 bis 90 cm Ø

P999 Trípode paellero / Base for burner / Pied pour brûleur / Dreifussständer für Gasbrenner



REF	
P999.000	1

Plegable apto para paelleros de 2 y 3 círculos /
Folding valid for 2 and 3 circles burners /
Pliant valable pour brûleurs de 2 et 3 cercles /
Klappbar geeignet für 2 bis 3 Kreisgasbrenner

VER PRODUCTOS EN / SEE PRODUCTS ON / VOIR PRODUITS EN PAGE / SIEHE PRODUKTE IN

COOKWARE PASSION & MEDITERRANEAN



P. 489





**HORNO Y RUSTIDERAS /
OVEN AND ROAST PAN /
FOUR ET PLAQUES À RÔTIR /
OFEN- UND BRATFORMEN**

3.1	RUSTIDERAS / ROAST PANS / PLAQUES À RÔTIR / BRÄTER	68
3.2	BANDEJAS HORNO GASTRONORM / GASTRONORM SHEET PANS / PLAQUES FOUR GASTRONORME / GASTRONORM OFENBLECHE	70
3.3	BANDEJAS PASTELERÍA / PASTRY TRAYS / PLAQUES À PÂTISSERIE / PATISSERIETABLETT	72
3.4	REJILLAS / GRIDS / GRILLES / ROST	74
3.5	BANDEJAS ESPECIALES / SPECIAL BAKING SHEET / PLAQUE FOUR SPÉCIALE / SPEZIALBLECHE	75
3.6	BANDEJAS PARA PIZZA / PIZZA BAKING SHEETS / PLAQUES À PIZZA / PIZZABLECHE	77
3.7	ACCESORIOS HORNO / OVEN ACCESSORIES / ACCESSOIRES FOUR / OFENACCESSORIES	78

3.1 HORNO Y RUSTIDERAS / OVEN AND ROAST PAN /
FOUR ET PLAQUE À RÔTIR / OFEN UND BRATFORMEN

**RUSTIDERAS /
ROAST PANS /
PLAQUES À RÔTIR /
BRÄTER**



P309 Rustidera asas móviles / Roast pan falling handles /
Plaque à rôtir anses tombantes / Bräter mit beweglichen Griffen

INOX - ST/STEEL
EDELSTAHL
18/10

REF	cm (int)	cm (ext)	H cm	Lts	
P309.035	35 x 27	37,5 x 29,5	5,5	5,20	1
P309.040	40 x 30	43 x 33	6,5	6,50	1
P309.050	50 x 35	54 x 39	7,0	11,00	1
P309.060	60 x 40	64 x 44	9,0	19,00	1



P113 Rustidera asas móviles / Roast pan falling handles /
Plaque à rôtir anses tombantes / Bräter mit beweglichen Griffen

ALUMINIO /
ALUMINIUM



REF	cm	H cm	Lts	
P113.030	30 x 23	5,0	3,00	1
P113.035	35 x 27	5,5	5,00	1
P113.040	40 x 30	6,5	6,30	1
P113.045	45 x 32	6,5	7,60	1
P113.050	50 x 35	7,0	10,80	1
P113.055	55 x 40	8,0	15,50	1
P113.060	60 x 40	9,0	19,00	1
P113.065	65 x 45	10,0	25,70	1
P113.070	70 x 45	10,0	27,70	1



P122 Rustidera antiadherente asas móviles / Non-stick roast pan falling handles /
Plaque à rôtir anti-adhésive anses tombantes / Bräter mit beweglichen Griffen

ALUMINIO /
ALUMINIUM

REF	cm	H cm	Lts	
P122.040	40 x 30	6,5	6,30	1
P122.050	50 x 35	7,0	10,80	1
P122.060	60 x 40	9,0	19,00	1



P114 Rustidera asas fijas / Roast pan fixed handles /
Plaque à rôtir avec poignées fixes / Bräter mit festen Griffen

ALUMINIO /
ALUMINIUM

REF	cm	H cm	Lts	
P114.040	40 x 30	6,5	6,30	1
P114.045	45 x 32	6,5	7,60	1
P114.050	50 x 35	7,0	10,80	1
P114.060	60 x 40	9,0	19,00	1
P114.070	70 x 45	10,0	27,70	1



BLACK ELEGANCE

P1145 Rustidera aluminio presentación antiadherente / Non-stick presentation aluminium roast pan /
Plaque à rôtir anti-adhésive présentation / Bräter Antihaft Aluminiumpräsentation

ALUMINIO /
ALUMINIUM

REF	cm	H cm	Lts	
P114.540	40 x 30	6,5	6,30	1
P114.545	45 x 32	6,5	7,60	1



3.2 HORNO Y RUSTIDERAS / OVEN AND ROAST PAN /
FOUR ET PLAQUE À RÔTIR / OFEN UND BRATFORMEN

**BANDEJAS HORNO GASTRONORM /
GASTRONORM SHEET PANS /
PLAQUES FOUR GASTRONORME /
GASTRONORM OFENBLECHE**



P3180 Bandeja gastronorm / Gastronorm sheet /
Plaque gastronorme / Gastronormtablett

INOX - ST/STEEL
EDELSTAHL
18/10

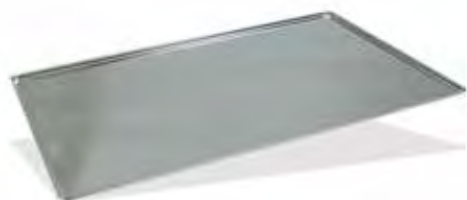

Grosor: 1 mm
Thickness: 1 mm
Épaisseur: 1 mm
Dicke: 1 mm

REF	TIPO / TYPE	mm	H mm	
P318.005	1/1	530 x 325	8,0	1

P3182 Bandeja honda gastronorm /
Deep gastronorm sheet /
Plaque gastronorme fonde /
Tiefes Gastronormtablett

INOX - ST/STEEL
EDELSTAHL
18/10



Grosor: 0,7 mm
Thickness: 0,7 mm
Épaisseur: 0,7 mm
Dicke: 0,7 mm

REF	TIPO / TYPE	mm	H mm	
P318.211	1/1	530 x 325	20,0	1

P1323 Bandeja GN antiadherente /
Non-stick GN pan tray /
Plaque GN anti-adhésive /
Antihaft Tablett GN

ALUMINIO /
ALUMINIUM



Grosor = 3 mm
Thickness = 3 mm
Épaisseur = 3 mm
Dicke: 3 mm

REF	TIPO / TYPE	H mm	Lts	
P132.365	1/1	65,0	7,90	1

P1325 Bandeja multiunidades /
Multi-units tray /
Plaque multi-unités /
Multieinheiten Tablett

ALUMINIO /
ALUMINIUM

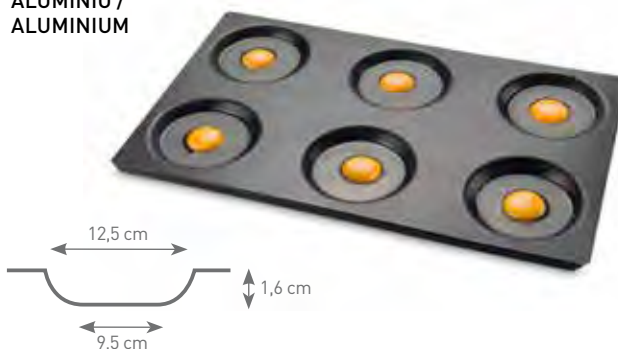

REF	TIPO / TYPE	mm	
P132.560	1/1	530 x 325	1

CUBETAS GASTRONORM / GASTRONORM CONTAINERS / BACS GASTRONORME / GASTRONORM BEHÄLTER

HORNO /
OVEN /
FOUR



**3.3 HORNO Y RUSTIFERAS / OVEN AND ROAST PAN /
FOUR ET PLAQUE À RÔTIR / OFEN UND BRATFORMEN**

**BANDEJAS PASTELERÍA /
PASTRY TRAYS /
PLAQUES À PÂTISSERIE /
PATISSERIETABLETT**



P318 Bandeja pastelería / Baking sheet /
Plaque à pâtisserie / Patisserietablett

INOX - ST/STEEL
EDELSTAHL
18/10



Grosor: 1 mm
Thickness: 1 mm
Epaisseur: 1 mm
Dicke: 1 mm

REF	mm	H mm	
P318.040	400 x 300	12,0	1
P318.060	600 x 400	12,0	1

P779 Bandeja pastelería / Baking sheet /
Plaque à pâtisserie / Patisserietablett

INOX - ST/STEEL
EDELSTAHL
18/10



Grosor: 0,7 mm
Thickness: 0,7 mm
Epaisseur: 0,7 mm
Dicke: 0,7 mm

REF	mm	H mm	
P779.017	255 x 175	10,0	1
P779.021	275 x 210	10,0	1
P779.026	300 x 260	10,0	1
P779.060	600 x 200	10,0	1

P778 Bandeja escuadrada / Tray for confectionery /
Plaque à pâtisserie / Rechteckiges Backblech

INOX - ST/STEEL
EDELSTAHL
18/10



REF	mm	H mm	
P778.040	400 x 300	10,0	1
P778.048	480 x 310	10,0	1
P778.060	600 x 400	10,0	1

**Marcos para bandejas escuadradas /
Rectangle for bakin sheets /
Rectangle pour plaques /
Rahmen für rechteckige Backbleche**

P777

INOX - ST/STEEL
EDELSTAHL
18/10



REF	mm	H mm	
P777.540	395 x 295	50,0	1
P777.548	475 x 305	50,0	1
P777.560	595 x 395	50,0	1

Marcos adaptables a las bandejas escuadradas de la ref. P778, P1232 y P1322
Rectangles that are adptable to the baking sheets of ref. P778, P1232 and P1322
Rectangles pour adapter aux plaques inox des réfs. P778, P1232 et P1322
Rahmen geeignet für rechteckige Backbleche Art.Nr. P778, P1232 und P1322

P123 Bandeja para pastelería /
Tray for confectionery /
Plaque à pâtisserie /
Patisserietablett

ALUMINIO /
ALUMINIUM



REF	mm	H mm	
P123.040	400 x 300	12,0	1
P123.060	600 x 400	12,0	1

P1231 Bandeja perforada para pastelería /
Perforated tray for confectionery /
Plaque à pâtisserie perforée /
Gelochtes Patisserietablett

ALUMINIO /
ALUMINIUM



REF	mm	H mm	
P123.140	400 x 300	12,0	1
P123.160	600 x 400	12,0	1

P1232 Bandeja para pastelería /
Tray for confectionery /
Plaque à pâtisserie /
Patisserietablett

ALUMINIO /
ALUMINIUM



REF	mm	H mm	
P123.240	400 x 300	12,0	1
P123.260	600 x 400	12,0	1

P132 Bandeja pastelería antiadherente /
Non-stick tray for confectionery /
Plaque à pâtisserie anti-adhésive /
Antihaft Patisserietablett

ALUMINIO /
ALUMINIUM



REF	mm	H mm	
P132.040	400 x 300	12,0	1
P132.060	600 x 400	12,0	1

P1321 Bandeja pastelería antiadherente perforada /
Perforated non-stick tray for confectionery /
Plaque à pâtisserie anti-adhésive perforée /
Antihaft Patisserietablett gelocht

ALUMINIO /
ALUMINIUM



REF	mm	H mm	
P132.140	400 x 300	12,0	1
P132.160	600 x 400	12,0	1

P1322 Bandeja pastelería antiadherente /
Non-stick tray for confectionery /
Plaque à pâtisserie anti-adhésive /
Antihaft Patisserietablett

ALUMINIO /
ALUMINIUM



REF	mm	H mm	
P132.240	400 x 300	12,0	1
P132.260	600 x 400	12,0	1

P9091 Rejilla gastronorm acero inox / St/Steel gastronorm grid /
Grille acier inoxydable gastronorm / Rostfreier Gastronormrost



REF	TIPO/ TYPE	mm	N. TRAVESAÑOS / N. CROSS-BARS / N. TRAVERSES / N. QUERSTÄBE	Ø mm TRAVESAÑOS / Ø mm CROSS-BARS / Ø mm TRAVERSES / Ø mm QUERSTÄBE	N. VARILLAS / N. WIRES / N. FILS / N. STÄBE	Ø mm VARILLAS / Ø mm WIRES / Ø mm FILS / Ø mm STÄBE	
P909.121	2/1	650 x 530	3	5	32	2	1
P909.111	1/1	530 x 325	2	5	20	2	1

P9093 Rejilla pastelería acero inox / St/Steel pastry grid /
Grille pâtisserie acier inoxydable / Rostfreier Patisserieirost



REF	mm	N. TRAVESAÑOS / N. CROSS-BARS / N. TRAVERSES / N. QUERSTÄBE	Ø mm TRAVESAÑOS / Ø mm CROSS-BARS / Ø mm TRAVERSES / Ø mm QUERSTÄBE	N. VARILLAS / N. WIRES / N. FILS / N. STÄBE	Ø mm VARILLAS / Ø mm WIRES / Ø mm FILS / Ø mm STÄBE	
P909.340	400 x 300	2	5	22	2	1
P909.360	600 x 400	3	5	29	2	1

P9094 Rejilla pastelería reforzada acero inox / St/Steel reinforced pastry grid /
Grille pâtisserie acier inoxydable renforcée / Rostfreier Patisserieirost verstärkt



REF	mm	N. TRAVESAÑOS / N. CROSS-BARS / N. TRAVERSES / N. QUERSTÄBE	Ø mm TRAVESAÑOS / Ø mm CROSS-BARS / Ø mm TRAVERSES / Ø mm QUERSTÄBE	N. VARILLAS / N. WIRES / N. FILS / N. STÄBE	Ø mm VARILLAS / Ø mm WIRES / Ø mm FILS / Ø mm STÄBE	
P909.460	600 x 400	2	6	24	3	1

P9092 Rejilla gastronorm con Rilsan blanco / White rilsan steel gastronorm grid /
Grille gastronorm en acier et rilsan blanc / Gastronormrost mit weissem Rilsan



OVEN



REF	TIPO/ TYPE	mm	N. TRAVESAÑOS / N. CROSS-BARS / N. TRAVERSES / N. QUERSTÄBE	Ø mm TRAVESAÑOS / Ø mm CROSS-BARS / Ø mm TRAVERSES / Ø mm QUERSTÄBE	N. VARILLAS / N. WIRES / N. FILS / N. STÄBE	Ø mm VARILLAS / Ø mm WIRES / Ø mm FILS / Ø mm STÄBE	
P909.221	2/1	650 x 530	3	5	22	5	1
P909.211	1/1	530 x 325	2	5	13	5	1

VER PRODUCTOS EN / SEE PRODUCTS ON / VOIR PRODUITS EN PAGE / SIEHE PRODUKTE IN

UTENSILIOS PASTELERÍA /
PASTRY UTENSILS /
USTENSILES PÂTISSERIE /
PATISSERIEZUBEHÖR

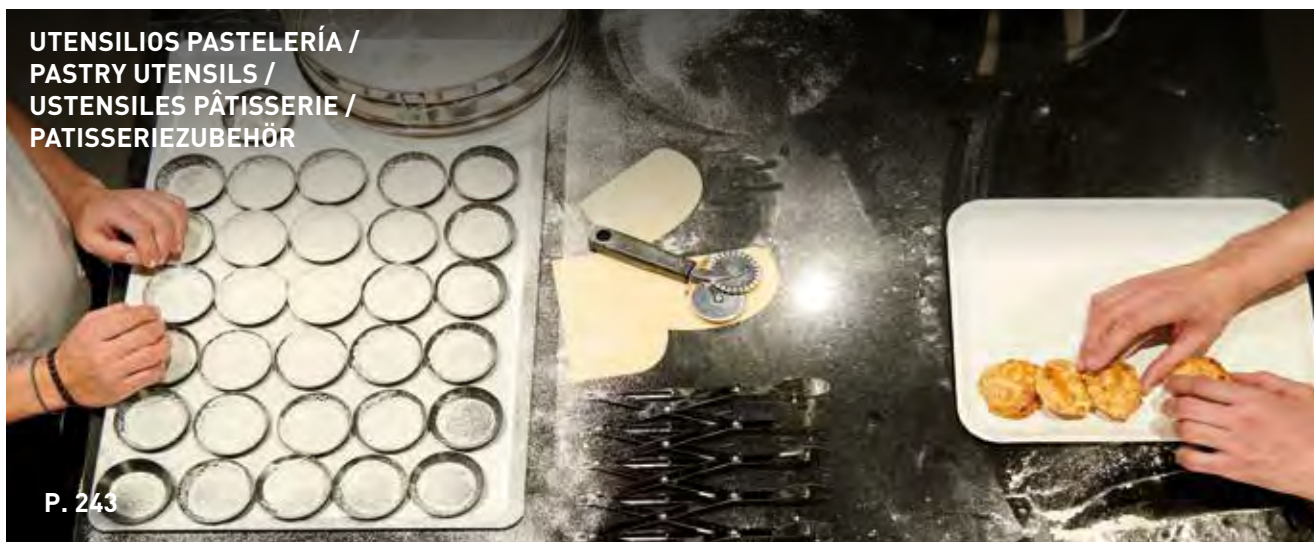

P. 243



BANDEJAS ESPECIALES / SPECIAL BAKING SHEET / PLAQUE FOUR SPÉCIALE / SPEZIALBLECHE



HORNO /
OVEN /
FOUR

P152 Rustidera / Roast pan / Plaque à rôtir / Bräter



Aluminio fundición /
Cast aluminium /
Fonte d'aluminium /
AluminiumGuss



*MINI-SIZE

IDEA!

Ideal para presentación
Ideal for food presentation
Idéal pour présentation
Ideal für die Präsentation

REF	Ø cm	H cm	
P152.025*	25 x 20	6,5	1
P152.030	30 x 22	7,0	1
P152.035	35 x 25	7,5	1

P153025 Parrilla plana con asas / Hot-plate with handles / Grill plat avec poignées / Flache Bratplatte mit Griffen



Aluminio fundición /
Cast aluminium /
Fonte d'aluminium /
AluminiumGuss



REF	Ø cm	H cm	
P153.025	25 x 25	2,0	1

P153034 Parrilla plana con asas / Hot-plate with handles / Grill plat avec poignées / Flache Bratplatte mit Griffen



Aluminio fundición /
Cast aluminium /
Fonte d'aluminium /
AluminiumGuss



REF	Ø cm	H cm	
P153.034	34 x 26	2,5	1

P153050 Parrilla plana con asas / Hot-plate with handles / Grill plat avec poignées / Flache Bratplatte mit Griffen



Aluminio fundición /
Cast aluminium /
Fonte d'aluminium /
AluminiumGuss



REF	Ø cm	H cm	
P153.050	50 x 30	2,5	1

3.5 HORNO Y RUSTIDERAS / OVEN AND ROAST PAN /
FOUR ET PLAQUE À RÔTIR / OFEN UND BRATFORMEN

**BANDEJAS HORNO ESPECIALES /
SPECIAL OVEN TRAY /
PLAQUES DE FOUR SPÉCIALES /
SPEZIAL-OFENBLECHE**



9002 Bandeja pastelería / Baking sheet / Plaque à pâtisserie / Patisserietablett

ALUMINIO /
ALUMINIUM



9002

5223

5303

5220

REF	mm	H mm	
9002	451 x 654	2,5	1
5223	381 x 533	2,5	1
5303	451 x 327	2,5	1
5220	241 x 330	2,5	1
5228	241 x 165	2,5	1



5220 / 5228
Ideal para presentación.
Ideal for food presentation.
Idéal pour présentation.
Ideal für die Präsentation.

VER PRODUCTOS EN / SEE PRODUCTS ON / VOIR PRODUITS EN PAGE / SIEHE PRODUKTE IN

**LLAUNA BANDEJA PRESENTACIÓN /
SHEET PAN PRESENTATION /
PLATEAU PRÉSENTATION /
BLECH PRÄSENTATIONS-TABLETT**



P. 489

**BANDEJAS PARA PIZZA /
PIZZA BAKING SHEETS /
PLAQUES À PIZZA /
PIZZABLECHE**

P705 Molde hondo pizza antiadherente / Non-stick deep pizza mould /
Moule haute pizza anti-adhésif / Tiefes Antihaft Pizzablech



REF	Ø cm	H cm	
P705.024	24	2,5	6
P705.028	28	2,5	6
P705.032	32	2,5	6

P736 Molde pizza antiadherente perforado /
Perforated non-stick pizza mould /
Moule à pizza anti-adhésif perforé /
Gelochtes Antihaft Pizzablech

Ø 8 mm
agujeros / holes /
trous / löcher



REF	Ø cm	H cm	
P736.030	30	1,3	6
P736.034	34	1,3	6

P929 Base pizza aluminio /
Aluminium pizza pan /
Plaque à pizza aluminium /
Aluminium Pizzablech



REF	Ø cm	
P929.025	25	1
P929.028	28	1
P929.030	30	1
P929.036	36	1
P929.040	40	1

P949 Base rejilla aluminio antiadherente para pizza /
Non-stick aluminium pizza screen /
Base maillée aluminium anti-adhésive pour pizza /
Antihaft Pizzagitter Aluminium



REF	Ø cm	
P949.025	25,5	1
P949.030	30,5	1
P949.035	35,5	1
P949.040	40,0	1

P963 Base rejilla aluminio para pizza /
Aluminium pizza screen /
Base maillée aluminium pour pizza /
Pizzagitter Aluminium



REF	Ø cm	
P963.025	25,0	1
P963.030	30,5	1
P963.035	35,5	1
P963.040	40,0	1

3.7 HORNO Y RUSTIDERAS / OVEN AND ROAST PAN / FOUR ET PLAQUE À RÔTIR / OFEN UND BRATFORMEN

ACCESORIOS HORNO / OVEN ACCESSORIES / ACCESSOIRES FOUR / OFENACCESSORIES

P977 Soporte para bases pizza 15 niveles /
Pizza pan rack 15 levels /
Support pour plaques à pizza 15 niveaux /
Ständer für Pizzableche 15 Ebenen



REF	cm	H cm	
P977.015	30,5 x 30,5	70,0	1

Recomendado para Ref. P929 hasta Ø36 cm
Suitable for item Code P929 up to Ø36 cm
Recommandé pour Réf. P929 jusqu'au Ø36 cm
Empfohlen für Ref. P929 bis Ø36 cm

P972 Papel siliconado /
Siliconized baking release papers /
Papier siliconé anti-adhésif /
Backpapier aus Silikon



REF	mm	UNIDADES / UNIT	
P972.060	600 x 400	500	1
P972.053	530 x 325	500	1

Caja de 500 unidades. Siliconado por las dos caras. Múltiples usos.
Gramaje 41 gr/m2. Resistente a la grasa. Color blanco.
Set of 500 units both sides siliconized. Multiple uses.
Grammage 41 gr/m2. Greaseproof. Bleached.
Boîte de 500 unités. Deux faces siliconées. Multiples utilisations.
Gramage 41 gr/m2. Résistant à la graisse. Couleur blanc.
Kiste mit 500 Stück. Beidseitig mit Silikon. Mehrfacher Gebrauch.
Gewicht 41 gr/m2. Resistent gegen Fett. Weiss.

P833 Tapete de silicona / non-stick silicone mat /
Toile de cuisson / Silikonmatte



- 40 °C
 + 260 °C

REF	mm	
P833.001	520 x 315	1
P833.002	585 x 385	1
P833.003	400 x 300	1

P607 Pinza fuente horno / roast pan tong /
Pince pour plaque à rôtir / Ofenblechzange



REF	L cm	
P607.000	19	1

P948 Pala pizza de aluminio / aluminium pizza peel /
Pelle à enfourner en aluminium / Aluminium Pizzaschaufel



REF	PALA / PEEL / PELLE / SCHAUFEL CM	L cm	
P948.066	31 x 35	66	1
P948.090	31 x 35	90	1
P948.132	31 x 35	132	1
P948.163	31 x 35	163	1



HORNO /
OVEN /
FOUR



pujadas

UTENSILIOS DE COCINA / KITCHEN UTENSILS / USTENSILES DE CUISINE / KÜCHENUTENSILIEN

4.1	UTENSILIOS DE COCINA / KITCHEN UTENSILS / USTENSILES DE CUISINE / KÜCHENUTENSILIEN	82, 110
------------	---	---------

4.2	VIOLET COLLECTION	101
------------	-------------------	-----

4.3	PROCESADORES MANUALES DE ALIMENTOS / MANUAL FOOD PROCESSORS / APPAREILS MANUELS DE TRANSFORMATION DES ALIMENTS / HANDLICHEN SCHNEIDEMASCHINEN GEEIGNET FÜR	121
------------	---	-----

4.4	TABLAS DE CORTE / CUTTING BOARDS / PLANCHES À DÉCOUPER / SCHNEIDBRETTER	138
------------	--	-----

4.5	ELEMENTOS DE MEDIDA / MEASURING UTENSILS / USTENSILES DE MESURE / MESSUTENSILIEN	141
------------	---	-----

4.6	MANOPLA / MITT / GAN / HANDSCHUHE	146
------------	-----------------------------------	-----

4.7	ALFOMBRAS CAUCHO / NATURAL RUBBER MATS / TAPIS EN CAOUTCHOUC / KAUSCHUKMATTEN	147
------------	--	-----

**Cacillo monobloc /
One piece ladle /
Louche monobloc /
P3011 Monoblock Schöpflöffel**

Capacidad marcada en el mango /
Capacity marked on the handle /
Capacité marqué à la queue /
Volumenangabe am Griff markiert



REF	Ø cm	L cm	Lts	
P301.165	6,5	31	0,07	12
P301.108	8	32	0,13	12
P301.109	9	33	0,20	12
P301.110	10	37	0,25	6
P301.112	12	42	0,45	6
P301.114	14	43	0,75	6
P301.116	16	45	1,00	6
P301.118	18	48	1,50	6

**Cacillo monobloc económico /
Economical one piece ladle /
Louche monobloc économique /
P3012 Monoblock Schöpflöffel ökonomisch**

Capacidad marcada en el mango /
Capacity marked on the handle /
Capacité marqué à la queue /
Volumenangabe am Griff markiert



REF	Ø cm	L cm	Lts	
P301.206	6	27	0,05	10
P301.208	8	31	0,12	10
P301.210	10	33	0,25	10
P301.212	12	36	0,42	10
P301.214	14	39	0,75	10
P301.216	16	43	1,20	10

**Cacillo para salsas con 2 picos laterales /
One piece sauce ladle with 2 spouts /
Cuillère à sauces monobloc avec 2 becs verseurs /
P392 Schöpflöffel für Sossen mit 2 seitlichen Ausgüssen**

Capacidad marcada en el mango /
Capacity marked on the handle /
Capacité marqué à la queue /
Volumenangabe am Griff markiert



REF	Ø cm	L cm	Lts	
P392.065	6,5	31	0,08	10

**Cacillo monobloc mango corto /
One piece ladle short handle /
Louche monobloc manche court /
P30326 Monoblock Schöpflöffel kurzer Stiel**

Capacidad marcada en el mango /
Capacity marked on the handle /
Capacité marqué à la queue /
Volumenangabe am Griff markiert



REF	Ø cm	L cm	Lts	
P303.265	6,5	22	0,07	10



**Cacillo monobloc con agujeros /
Perforated one piece ladle /
Louche monobloc perforée /
P396 Gelochter Monoblock Schöpflöffel**



REF	Ø cm	L cm	
P396.009	9	33	10
P396.010	10	37	10
P396.012	12	42	10

**Cacillo monobloc Kool-Touch® /
One-Piece ladle Kool-Touch® handle /
Louche monobloc manche Kool-Touch® /
4980120 Monoblock Schöpflöffel Kool-Touch® Griffen**



REF		Ø cm	L cm	ml	
4980120	Black	4,5	25,0	30	12
4980230	Blue	6,0	25,0	60	12
4980335	Yellow	7,5	32,0	90	12
4980445	Grey	8,5	32,0	120	12
4980655	Green	9,0	31,5	175	12
4980865	Orange	10,0	32,0	235	12

 82 °C Revestimiento mango / Coated handle /
Revêtement queue / Griffbeschichtung

P3021 Espumadera monobloc /
One piece skimmer /
Écumoire monobloc /
Schaumlöffel Monoblock



REF	Ø cm	L cm	
P302.108	8	29	10
P302.110	10	32	10
P302.112	12	35	10
P302.114	14	37	10
P302.116	16	44	5
P302.118	18	44	5
P302.120	20	47	5

P3141 Espátula monobloc sin perforar /
One piece spatula /
Spatule monobloc /
Pfannenwender Monoblock



REF	Ø cm	L cm	
P314.110	10	36	5
P314.112	12	39	5

P3143 Pala pescado monobloc /
One piece fish spatula /
Pelle à poisson monobloc /
Fischwender Monoblock



REF	cm	L cm	
P314.300	16 x 12	42	5

P3022 Espumadera monobloc económica /
Economical one piece skimmer /
Écumoire monobloc économique /
Schaumlöffel Monoblock ökonomisch



REF	Ø cm	L cm	
P302.210	10	33	10
P302.212	12	36	10
P302.214	14	39	10
P302.216	16	42	10

P3142 Espátula monobloc perforada /
One piece perforated spatula /
Spatule monobloc perforée /
Gelochter Pfannenwender Monoblock



REF	Ø cm	L cm	
P314.210	10	36	5
P314.212	12	39	5

P315 Espumadera de alambre / Mesh skimmer /
Écumoire à friture / Drahtschaumlöffel



REF	Ø cm	L cm	
P315.010	10	40	10
P315.012	12	43	10
P315.015	15	50	10
P315.017	17	54	10
P315.020	20	61,5	10

P94101 Araña / Wire skimmer /
Araignée / Schaumlöffel



REF	Ø cm	L cm	
P941.013	13	47,5	10
P941.015	15	49,5	10
P941.018	18	52,5	10
P941.020	20	54,5	10
P941.022	22	67,0	5
P941.024	24	69,0	5
P941.028	28	69,0	5

P955 Espumadera malla fina / Mesh skimmer /
Écumoire maillée / Feiner Drahtschaumlöffel



Detalle de la malla a escala real
Detail of the sieve at real scale
Détail de la maille à échelle réelle
Detail Maschen in realer Größe

REF	Ø cm	L cm	
P955.010	10	40	10
P955.012	12	43	10
P955.015	15	50	10
P955.017	17	54	10
P955.020	20	61	10

P394 Molde nido / Bird nest mould /
Moule à nid / Vogelnestform

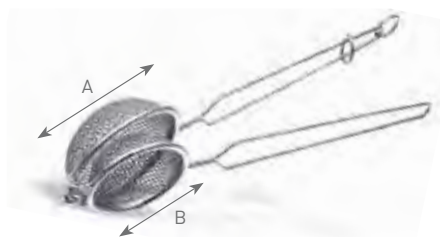

REF	Ø A cm	Ø B cm	
P394.008	10	8	1
P394.012	12	10	1

P376 Cuchara monobloc profesional /
Professional one piece spoon /
Cuillère monobloc professionnelle /
Professioneller Löffel Monoblock



REF	Ø cm	
P376.037	37	10

P3761

Cuchara honda monobloc profesional /
Professional one piece deep spoon /
Cuillère profonde monobloc professionnelle /
Tiefer professioneller Löffel Monoblock



REF	Ø cm	
P376.137	37	10

P377

Cuchara perforada monobloc profesional /
Professional one piece perforated spoon /
Cuillère perforée monobloc professionnelle /
Gelochter professioneller Löffel Monoblock



REF	Ø cm	
P377.037	37	10

P3771

Cuchara honda monobloc profesional perforada /
Professional one piece perforated deep spoon /
Cuillère profonde monobloc professionnelle perforée /
Tiefer gelochter professioneller Löffel Monoblock



REF	Ø cm	
P377.137	37	10

P395

Cuchara oblicua monobloc /
One piece crosswire spoon /
Cuillère oblique monobloc /
Sossenlöffel Monoblock



REF	L cm	BASE cm	Lts	
P395.038	38	10 x 7	0,075	10

64130 Cuchara / Solid spoons / Cuillères pleines / Massiv Löffel



232 °C

REF	Color	L cm	
64130		35	12
6414015		35	12
6414030		35	12
6414040		35	12
6414050		35	12
6414070		35	12

64132 Cuchara perforada / Perforated spoons / Cuillères perforées / Perforiert Löffel



232 °C

REF	Color	L cm	
64132		35	12
6414215		35	12
6414230		35	12
6414240		35	12
6414250		35	12
6414270		35	12

P3972 Tenedor monobloc / One piece meat fork / Fourchette monobloc / Fleischgabel Monoblock



2 púas / 2 prongs / 2 dents / 2 Zinken

REF	Ø cm	
P397.247	47	10

P3973 Tenedor monobloc / One piece meat fork / Fourchette monobloc / Fleischgabel Monoblock



3 púas / 3 prongs / 3 dents / 3 Zinken

REF	L cm	
P397.347	47	10

ANTIMICROBIAL

UTENSILIOS CON PROPIEDADES ANTIMICROBIALES NATURALES /
UTENSILS WITH NATURE'S ANTIMICROBIAL /
USTENSILES AVEC TRAITEMENT ANTIMICROBIEN /
SERVIERUTENSILIEN MIT NATUREIGENEM ANTIMIKROBIOTIKUM

ESPAÑOL

No es difícil imaginarse la gran cantidad de microbios que pueden transferirse a los utensilios de servicio, Y como los utensilios sucios no son compatibles con la comida, usted necesita el poder de la exclusiva tecnología antimicrobiana Agion® con iones de plata. Mientras los microbios se acumulan y multiplican en las superficies sin tratar, en los utensilios antimicrobianos éstos son atacados por los iones de plata.

ENGLISH

It's not hard to imagine how many of these nasty microbes can get transferred to serving utensils, And because dirty utensils and food do not get along, you need the power of exclusive Ion Antimicrobial Technology. While untreated surfaces allow microbes to collect and multiply, microbes are attacked by the silver ions in antimicrobial utensils.

FRANÇAIS

Il est facile d'imaginer le nombre de microbes nuisibles qui peuvent être transférés aux ustensiles de cuisson et de service, Et comme les ustensiles sales et les aliments ne font pas bon ménage, utilisez le pouvoir de la technologie antimicrobienne aux ions argent Agion®. Alors que les surfaces non traitées permettent aux microbes de se rassembler et de se multiplier, les ions argent des ustensiles antimicrobiens attaquent.

DEUTSCH

Es Ist Nicht Schwierig, sich die Große Menge an Mikroben Vorzustellen, die auf Servierutensilien Übertragen Werden Können. Und da sich Schmutzige Utensilien mit Nahrungsmitteln Nicht Vertragen, Benötigen sie die Exklusive Entimikrobentechnologie Agion® mit Silberionen. Während sich Mikroben auf Unbehandelten Oberflächen Ansammeln und Vermehren Können, Werden die auf Antimikrobiellen Servierutensilien von den Silberionen Angegriffen.

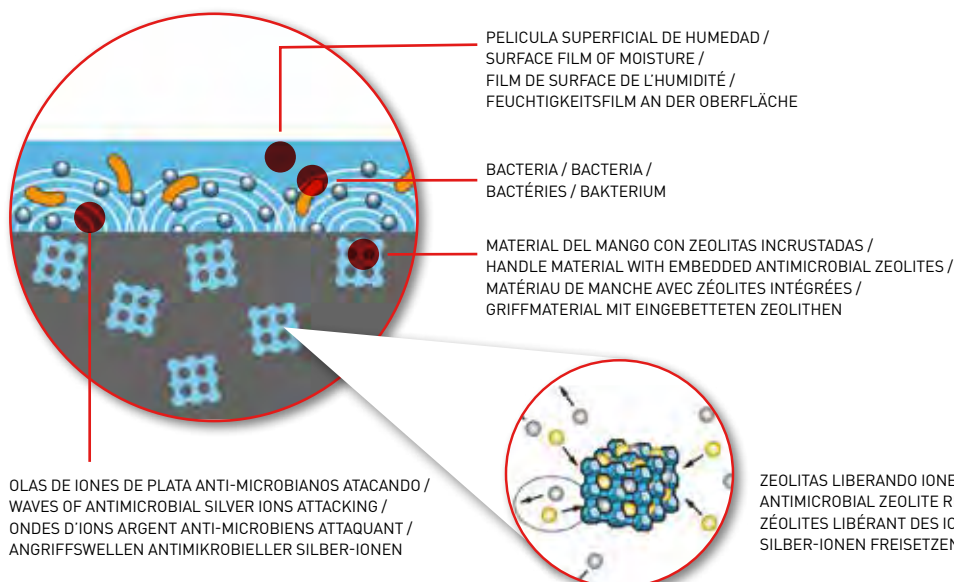

JP
JACOB'S PRIDE®
COLLECTION
GUARANTEED FOR LIFE

SPOODLE®

Mango con diseño ergonómico, de Nylon que reduce la fatiga durante su uso. Max temp 232 °C /

Handle with ergonomic design, made from nylon which reduces wear during use. Maximum temperature 232 °c /
Manche au design ergonomique en nylon qui réduit la fatigue pendant son emploi. Temp. Max. 232 °c /
Griff mit Ergonomischem Design aus Nylon, was den Verschleiß Während der Nutzung Reduziert. Max. Temp. 232 °C.

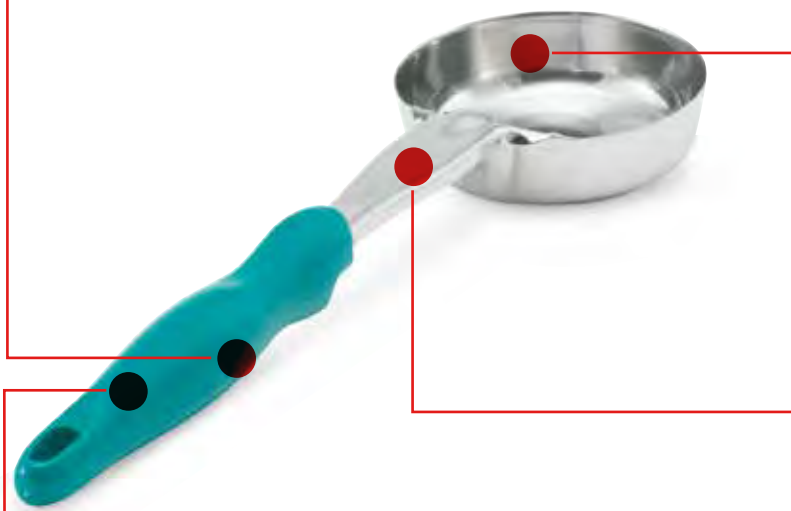

Mango y porcionadores de acero inoxidable brillante — resistente a la corrosión /

Mirror-finished stainless steel shafts and bowls — resistant to corrosion /
Tiges et cuillerons en acier inoxydable ultra-brillant — résistant à la corrosion /
Stiel und Höhlungen aus hochglanz-polierstem Edelstahl – gegen Korrosion beständig.

Capacidad marcada en el mango /

Capacity marked on the handle /
Capacité marqué à la queue /
Volumenangabe am Griff markier.

COLOR / COLOR / COULEUR / FARBE	ml
Blue	60
Orange	90
Grey	120
Teal	175
Red	235

Exclusivo diseño ovalado, que permite acceder de forma fácil a las esquinas de las cubetas, maximizando el aprovechamiento del contenido del recipiente /

Unique oval bowl design fits into corners of steam table pans, reducing waste and MAXIMIZING serving efficiency /
Design oval unique qui permet d'atteindre tous les coins du bag, tout en réduisant la quantité de déchets et l'augmentation de l'efficacité du service /
Exklusives ovales Design, das es erlaubt, ganz einfach in die Ecken des Behälters zu kommen, so dass der Inhalt des Behälters maximal ausgenutzt werden kann.



Superficie texturizada para impedir derrames durante el uso /

Textured surface prevents slippage while in use /
La surface texturée empêche la cuillère de glisser dans le récipient /
Texturierte Oberfläche verhindert ein Abrutschen während des Gebrauchs.



Muesca para impedir que el cucharón se deslice dentro del recipiente /

Built-in stopper notch prevents utensils from sliding into food product /
Encoche-butée intégrée pour empêcher les ustensiles de glisser dans le produit alimentaire /
Integrierte Kerbe Verhindert, dass die Utensilien in die Speise Hineinrutschen.

**6433230 Spoodle® monobloc redondo / One-Piece Round Spoodle® /
Spoodle® monobloc ronde / Monoblok Rundschaalen Spoodle®**



REF		Ø cm	L cm	ml	
6433230		6,5	32	60	12
6433335		7,4	33	90	12
6433445		8,2	34	120	12
6433655		9,3	35	175	12
6433865		10,2	36	235	12

232 °C

**6432230 Spoodle® monobloc redondo perforado / One-Piece Round Perforated Spoodle® /
Spoodle® monobloc ronde perforé / Monoblok Perforierten Rundschaalen Spoodle®**



REF		Ø cm	L cm	ml	
6432230		6,5	32	60	12
6432335		7,4	33	90	12
6432445		8,2	34	120	12
6432655		9,3	35	175	12
6432865		10,2	36	235	12

232 °C

**6412230 Spoodle® monobloc oval / One-Piece Oval Spoodle® /
Spoodle® monobloc oval / Monoblok Ovalschaalen Spoodle®**



REF		L x W cm	L cm	ml	
6412230		7,5 x 6,8	33,0	60	12
6412335		8,5 x 7,8	34,0	90	12
6412445		9,4 x 8,6	35,0	120	12
6412655		10,7 x 9,8	36,5	175	12
6412865		11,8 x 10,7	37,5	235	12

232 °C

**6422230 Spoodle® monobloc oval perforado / One-Piece oval Perforated Spoodle® /
Spoodle® monobloc oval perforé / Monoblok Perforierten Ovalschaalen Spoodle®**



REF		L x W cm	L cm	ml	
6422230		7,5 x 6,8	33,0	60	12
6422335		8,5 x 7,8	34,0	90	12
6422445		9,4 x 8,6	35,0	120	12
6422655		10,7 x 9,8	36,5	175	12
6422865		11,8 x 10,7	37,5	235	12

232 °C

VER PRODUCTOS EN / SEE PRODUCTS ON / VOIR PRODUITS EN PAGE / SIEHE PRODUKTE IN

SPOODLE®

ANTIALÉRGICO / ALLERGEN - FREE /
ANTI ALLERGIQUE / ANTI ALLERGIE

P. 106



VER PRODUCTOS EN / SEE PRODUCTS ON /
VOIR PRODUITS EN PAGE / SIEHE PRODUKTE IN

P. 245

5284220 Cuchara nylon / Nylon spoon / Cuillère nylon / Nylonlöffel



+ 245 °C

5284220



5284320



REF	Color	L cm	
5284220		34	12
5284320		34	12

4689760 Cuchara nylon para preparación / Nylon spoon for preparation / Cuillère nylon pour préparation / Nylonlöffel für die Zubereitung

+ 205°C



REF	Color	L cm	
4689760		21,6	12
4689815		30,5	12
4689830		30,5	12
4689840		30,5	12
4689850		30,5	12
4689860		30,5	12
4689960		38,1	12

47139 Porcionador / Thumb disher / Cuillère de service / Portionierer



REF	Color	TAMAÑO / SIZE	Ø mm	Mlts	
47139		6	76	157,7	12
47140		8	73	118,3	12
47141		10	70	96,1	12
47142		12	64	78,9	12
47143		16	57	59,1	12
47144		20	52	48,1	12
47145		24	48	39,4	12
47146		30	44	29,6	12

47390 Porcionador apretable / Squeeze disher / Cuillère-pression de service / Eisportionierer



REF	Color	TAMAÑO / SIZE	Ø mm	Mlts	
47390		6	76	139	12
47391		8	73	110	12
47392		10	70	96	12
47393		12	64	84	12
47395		16	57	59	12
47396		20	52	53	12
47397		24	48	45	12
47398		30	44	33	12
47399		36	44	28	12
47403		70	32	14	12

VER PRODUCTOS EN / SEE PRODUCTS ON / VOIR PRODUITS EN PAGE / SIEHE PRODUKTE IN

ESPÁTULA SILICONA ALTA TEMPERATURA /
HIGH HEAT SILICONE SPATULA. BOWL SCRAPER /
SPATULE SILICONE HAUTE TEMPÉRATURE /
SILIKONSPACHTEL HOHE TEMPERATUREN

P. 246



P34001 Cacillo /
Ladle /
Louche /
Schöpflöffel

Nylon



REF	L cm	Lts	
P340.010	28,5	0,08	12

P34002 Espumadera /
Skimmer /
Écumoire /
Schaumlöffel

Nylon



REF	L cm	Ø cm	
P340.020	27	10,7	12

P34003 Cuchara de servicio /
Serving spoon /
Cuillère de service /
Servierlöffel

Nylon



REF	L cm	
P340.030	27,5	12

P34004 Espátula /
Turner /
Spatule /
Pfannenwender

Nylon



REF	L cm	
P340.040	28,5	12

P34005 Espátula wok /
Wok spatula /
Spatule wok /
Wokspachtel

Nylon



REF	L cm	
P340.050	27,5	12

P34006 Espátula pastelera /
Baker spatula /
Palette /
Kuchenheber

Nylon



REF	L cm	
P340.060	29	12

P34007 Cuchara espagueti /
spaghetti server /
Cuillère à spaghetti /
Spaghettilöffel

Nylon



REF	L cm	
P340.070	29	12

P34008 Tenedor /
Meat fork /
Fourchette /
Fleischgabel

Nylon



REF	L cm	
P340.080	29,5	12

P34009 Pinza /
Tong /
Pince /
Zange

Nylon



REF	L cm	
P340.090	30,5	12





Pinzas ideales para emplatar y decorar
Plating tongs for careful lifting, turning and decorating
Pincas idéales pour la présentation et la décoration
Ideale Zangen Zum Anrichten und Dekorieren

INOX - ST/STEEL
EDELSTAHL
18/10

P3434 Pinza chef precisión extra larga (fina) /
Extra long fine tip straight tweezer (narrow) /
Pince du chef précision extra long (étroite) /
Extra lange Präzisionspinzette (schmal)

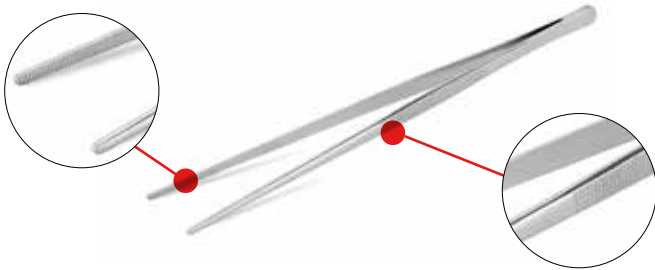

REF	L cm	
P343.400	30	1

P3435 Pinza chef precisión extra larga (ancha) /
Extra long fine tip straight tweezer (wide) /
Pince du chef précision extra long (large) /
Extra lange Präzisionspinzette (breit)

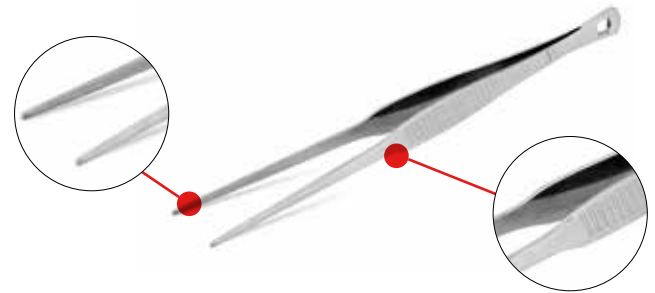

REF	L cm	
P343.500	30	1

P3436 Pinza chef precisión /
Fine tip straight tweezer /
Pince du chef précision /
Präzisionspinzette

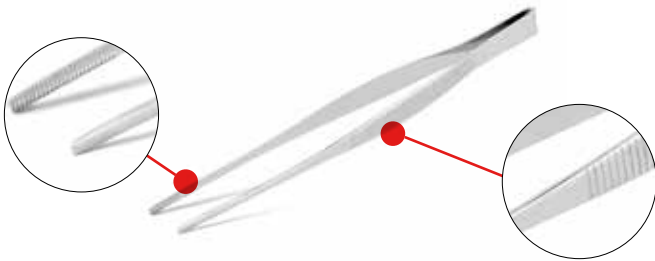

REF	L cm	
P343.600	21	1

P3437 Pinza Chef precisión pequeña /
Small fine tip straight tweezer /
Pince du chef précision petite /
Kleine Präzisionspinzette

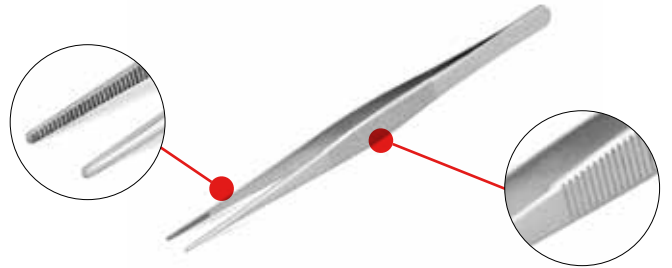

REF	L cm	
P343.700	16	1

P3438 Pinza sushi / Sushi tweezer /
Pince à sushi / Sushipinzette

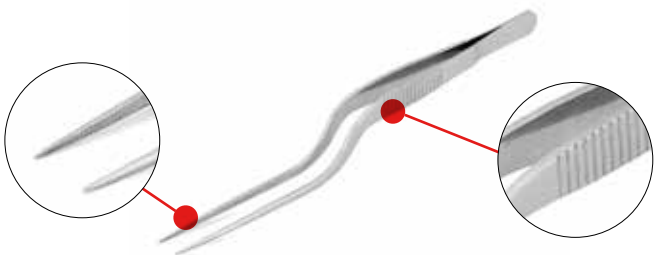

REF	L cm	
P343.800	16	1

VER PRODUCTOS EN / SEE PRODUCTS ON /
VOIR PRODUITS EN PAGE / SIEHE PRODUKTE IN

ARO REDONDO PARA TARTA /
ICE CREAM CAKE RING /
CERCLE À VACHERIN /
RUNDER TORTENRING



P. 260



P358 INOX Pinza buffet / Utility tong / Pince buffet / Buffetzange



REF	L cm	
P358.024	24,0	12
P358.029	29,5	12
P358.040	40,0	12

P358 COLOR Pinza buffet inox mango color / st. steel utility tong coloured handle / Pince buffet inox manche couleur / Rostfreie Buffetzange mit farbigem Griff



REF	L cm	BLANCO / WHITE / BLANC / WEISS	ROJO / RED / ROUGE / ROT	AZUL / BLUE / BLEU / BLAU	AMARILLO / YELLOW / JAUNE / GELB	VERDE / GREEN / VERT / GRÜN	MARRÓN / BROWN / MARRON / BRAUN	NEGRO / BLACK / NOIR / SCHWARZ	
P358	24	1	2	3	4	5	6	7	1
P358	30	1	2	3	4	5	6	7	1
P358	40	1	2	3	4	5	6	7	1

Ref : P358 + L + Color / Colour / Couleur / Farbe

Fabricadas en acero inoxidable monobloc. Mango con revestimiento PVC aislante para una mejor sujeción /
Made of one piece St/Steel. Handle with PVC coating for a better grip and insulation /
Fabriquées en acier inoxydable monobloc. Manche avec revêtement PVC pour une meilleure préhension et isolation /
Hergestellt aus rostfreien Monoblock. Griff mit PVC Beschichtung für bessere Griffigkeit und Isolierung.



Fabricadas en acero inox, de una sola pieza, en forma de W que aseguran una máxima resistencia y durabilidad.

Made of a single piece of stainless steel, in a W form to ensure maximum resistance and durability.

Fabriquées en acier inox, en une seule pièce, en forme de W, garantissant une résistance et une durabilité maximums.

Aus rostfreiem Stahl, einteilig, in W-Form, was maximale Widerstandskraft und Langlebigkeit garantiert.



Forma /Shape /
Forme / Form

 **VIOLET
COLLECTION**
P. 106



















4780920 Pinza buffet monobloc Kool-Touch® / One-Piece utility tong Kool-Touch® /
Pince buffet Kool-Touch® / Einteilige, farblich gekennzeichnete Kool-Touch® gewellter Servierzangen



Festoneada.
Scalloped.
Festonné.
Gewellt.

 **82 °C**

Revestimiento mango / Coated handle /
Revêtement queue / Griffbeschichtung

REF	Color	L cm	
4780920		24	12
4781220		30	12
4781620		40	12
4780930		24	12
4781230		30	12
4781630		40	12
4780940		24	12
4781240		30	12
4781640		40	12
4780950		24	12
4781250		30	12
4781650		40	12
4780960		24	12
4781260		30	12
4781660		40	12
4780970		24	12
4781270		30	12
4781670		40	12



Forma /Shape /
Forme / Form

4780620 Pinza buffet monobloc Kool-Touch® / One-Piece tong Kool-Touch® /
Pince buffet inox Kool-Touch® / Rostfreie Buffetzange Kool-Touch®



Festoneada.
Scalloped.
Festonné.
Gewellt.



Forma /Shape /
Forme / Form

REF	Color	L cm	
4780620		15	12
4780630		15	12
4780640		15	12
4780650		15	12
4780660		15	12
4780670		15	12

Pinza más corta para espacios estrechos o comida delicada /
Shorter utility tong for tight spaces or delicate food applications /
Pince utilitaire courte pour espaces restreints ou aliments délicats à manipuler /
Kürzere Universalzange für beengte Platzverhältnisse und das Arbeiten mit delikaten Speisen

4780912 Pinza con extremo de nylon / Utility tong with nylon end /
Pince utilitaire avec extrémité nylon / Universalzange mit Nylonenden



Festoneada.
Scalloped.
Festonné.
Gewellt.
● 232 °C

REF	L cm	
4780912	24	12
4781212	30	12
4781612	40	12

Forma / Shape /
Forme / Form Inox + Nylon / St/Steel + Nylon /
Rostfreier Stahl + Nylon

4780922 Pinza con extremo de nylon y asa revestida / Utility tong with nylon end & coated handle /
Pince utilitaire avec extrémité nylon et manche plastifié /
Universalzange mit Nylonenden u. beschichtetem Griff



Festoneada.
Scalloped.
Festonné.
Gewellt.
● 232 °C

Revestimiento mango.
Coated handle.
Revêtement queue.
Griffbeschichtung.
● 82 °C

REF	L cm	
4780922	24	12
4781222	30	12
4781622	40	12

Forma / Shape /
Forme / Form Inox + Nylon / St/Steel + Nylon /
Rostfreier Stahl + Nylon

4780610 Pinza de acero inoxidable / Stainless steel tong / Pince inoxydable / Edelstahl-Servierzange



Festoneada.
Scalloped.
Festonné.
Gewellt.

Forma / Shape /
Forme / Form

REF	L cm	
4780610*	15,2	12
4780910	24,1	12
4781210	30,5	12
4781610	40,6	12

* Pinza mas corta para espacios estrechos o comida delicada /
Shorter utility tong for tight spaces or delicate food applications /
Pince utilitaire courte pour espaces restreints ou aliments delicats
a manipuler /
Kurzere Universalzange fur beengte Platzverhältnisse und das
Arbeiten mit delikaten Speisen

4790910 Pinza VERSAGRIP® de acero inoxidable / VERSAGRIP® Stainless steel tong /
Pince inox VERSAGRIP® / VERSAGRIP® Edelstahl-Servierzange

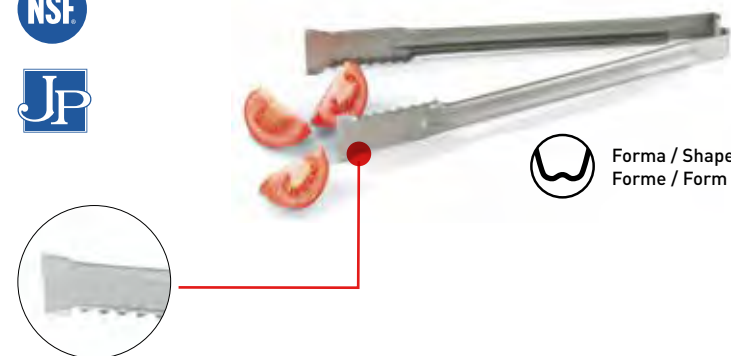

Forma / Shape /
Forme / Form

REF	L cm	
4790910	24,1	12
4791210	30,5	12
4791610	40,6	12

IDEA!

Ideal para barbacoa.
Perfect for grills and broilers.
Idéal pour barbecue.
Ideal zum Grillen.

VERSAGRIP®
presenta extremos aplanados y dentados para mayor agarre.
Features flattened ends and gripper teeth.
Offre des extrémités aplaties et crantées pour une
meilleure prise.
Mit abgeflachten Enden und gezahntem Greifer.

47046 Pinza dentada reforzada /
Reinforced Pom Tong /
Pince ceinture renforcée /
Verstärkte Gezahnte Zange



**INOX - ST/STEEL
EDELSTAHL**

Construcción de una sola pieza / One-piece construction /
Construction monobloc / Einteilige Ausführung

REF	L cm	
47046	15,2	36
47049	22,9	24
47042	30,5	12

P611 Pinza dentada / Pom tong /
Pince ceinture / Gezahnte Zange



REF	L cm	
P611.001	24	24

P620 Pala chips / chip bagger /
Pelle à frites / Frittenschaufel



REF	cm	
P620.001	23 x 21	1

Mano derecha / Right hand
Main droite / Rechtshändig

47326 Pinza dentada reforzada Kool-Touch® /
Kool-Touch® Reinforced Pom Tong /
Pince ceinture renforcée Kool-Touch® /
Kool-Touch® Verstärkte Gezahnte Zange



**INOX - ST/STEEL
EDELSTAHL**

Construcción de una sola pieza / One-piece construction /
Construction monobloc / Einteilige Ausführung

REF	L cm	
47326	15,2	12
47329	22,9	12
47322	30,5	12

47325 Pinza tipo tijeras de uso intensivo /
Heavy-Duty scissor tongs /
Pincas type ciseaux à usage intensif /
Scherenzange für starke Beanspruchung



REF	Color	L cm	
47325		38	12

P621 Pala chips ABS / ABS chip bagger /
Pelle à frites en ABS / Frittenschaufel ABS



Ref. 621.000 (dual)



Ref. 621.001
(mano derecha / right hand /
Main droite / rechtshändig)

REF	cm	
P621.000	23 x 21	1
P621.001	23 x 21	1

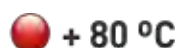

4808720 Espátula lisa, biselada /
Solid, beveled turner with /
Palette pleine, biseautée /
Pfannenwender für schwere
Beanspruchung Griffen massiv abgeschragt



EXTRA RESISTENTE /
HEAVY DUTY /
EXTRA RÉSISTANT /
EXTRA-RESISTENT

232 °C

Ergo Grip®
Mango / Handle /
Queue / Griff

REF	Color	(L x W) cm	L cm	
4808720		15 x 7,5	34,5	12
4808715		15 x 7,5	34,5	12

4808820 Espátula reforzada /
Solid Turner /
Palette renforcée /
Edelstahl-Pfannenwender für schwere
Beanspruchung massiv



EXTRA RESISTENTE /
HEAVY DUTY /
EXTRA RÉSISTANT /
EXTRA-RESISTENT

232 °C

Ergo Grip®
Mango / Handle /
Queue / Griff

REF	Color	(L x W) cm	L cm	
4808820		21 x 7,5	42	12
4808815		21 x 7,5	42	12

4808920 Espátula perforada reforzada /
Perforated Turner with /
Palette perforée renforcée /
Edelstahl-Pfannenwender für
schwere Beanspruchung perforiert



EXTRA RESISTENTE /
HEAVY DUTY /
EXTRA RÉSISTANT /
EXTRA-RESISTENT

232 °C

Ergo Grip®
Mango / Handle /
Queue / Griff

REF	Color	(L x W) cm	L cm	
4808920		21 x 7,5	42	12
4808915		21 x 7,5	42	12

5284120 Espátula nylon reforzada /
Slotted reinforced nylon turner /
Spatule renforcée à nylon /
Hochtemperaturbeständiger
Nylon-Pfannenwender,
Geschlitzter Wender



EXTRA RESISTENTE /
HEAVY DUTY /
EXTRA RÉSISTANT /
EXTRA-RESISTENT

245 °C

Nylon

REF	Color	L cm	
5284120		34,5	12

Construcción de una sola pieza / One-piece construction /
Construction monobloc / Einteilige Ausführung

MANGO ABS / ABS HANDLE / MANCHE EN ABS / ABS GRIFF

P381 Espátula triangular "pintor" /
Cleaning spatula / Palette triangle /
Dreieckige Reinigungsspachtel



REF	cm	L cm	
P381.008	8	24,5	12
P381.010	10	25	12

P383 Pala fast-food y pescado /
Fast-food and fish turner /
Palette fast-food et poisson /
Fast-Food und Fischschaufel

Flexible /
Flexibel



REF	cm	L cm	
P383.000	7,3 x 25	38	12

P386 Rasqueta / Dough scraper /
Raclette / Schaber



REF	cm	
P386.000	15 x 7,5	12

P385 Espátula pastelera / Baker spatula / Palette / Kuchenspachtel



P382 Pala bar / Spatula / Palette / Spachtel



REF	cm	L cm	
P382.000	7 x 16	29	12

P384 Pala fast-food perforada /
perforated fast-food turner /
Palette fast-food perforée /
Fast-Food Schaufel gelocht

Flexible /
Flexibel



REF	cm	L cm	
P384.000	7,3 x 25	38	12

P380 Ruleta cortapizzas / Pizza wheel /
Roulette à pizza / Pizzaschneider



REF	cm	L cm	
P380.000	10	23,5	12

REF	PALA / PEEL / PELLE / BLATT cm	L cm	
P385.020	20,5	34	12
P385.026	26	39	12
P385.030	30	43,5	12

P3855 Espátula para untar /
Butter spreader /
Couteau à beurre /
Aufstrichspachtel



REF	PALA / PEEL / PELLE / BLATT cm	L cm	
P385.500	10,4 x 3,4	23	12

P872 Pala pasteles /
Cake server /
Pelle à gâteau /
Keksschaufel

Sin sierra /
Without saw /
Sans scie /
Ohne säge



REF	L cm	
P872.000	28	12

P37501 Rasqueta triangular. Mango madera /
Triangle dough scraper. Wood handle /
Raclette triangle. Manche en bois /
Dreieckiger Schaber. Holzgriff



REF	PALA / PEEL / PELLE / BLATT cm	L cm	
P375.010	10,2 x 10	21	12

P37506 Pala bar. Mango madera /
Spatula. Wood handle /
Palette. Manche en bois /
Schaufel. Holzgriff



REF	PALA / PEEL / PELLE / BLATT cm	L cm	
P375.061	15,2 x 7,6	29	12

P37507 Rasqueta rectangular. Mango madera /
Rectangular dough scraper. Wood handle /
Raclette rectangle. Manche en bois /
Rechteckiger Schaber. Holzgriff



REF	PALA / PEEL / PELLE / BLATT cm	L cm	
P375.070	15,2 x 7,6	11,3	12

P37511 Espátula para untar. Mango madera /
Butter spreader. Wood handle /
Couteau à beurre. Manche en bois /
Aufstrichspachtel. Holzgriff



REF	PALA / PEEL / PELLE / BLATT cm	L cm	
P375.110	10,2 x 3,3	19,7	12

V I O L E T

C O L L E C T I O N

ANTIALÉRGICO / ALLERGEN-FREE / ANTI ALLERGIQUE / ANTI ALLERGIE

UTENSILIOS /
UTENSILS /
USTENSILLES

EVITA CONTAMINACIÓN CRUZADA /
AVOID CROSS CONTAMINATION /
ÉVITE LA CONTAMINATION CROISÉE /
VERHINDERT KREUZKONTAMINATION



ESPAÑOL

Determine los utensilios pequeños que va a usar para preparar y servir comidas que no contengan alérgenos. Color morado para una rápida identificación por parte de los empleados y clientes.

ENGLISH

Designate those smallwares which are to be used for preparing and serving allergen free meals
Purple color for quick identification by employees and customers.

FRANÇAIS

Déterminez les petits ustensiles que vous allez utiliser pour préparer et servir des repas sans allergènes. Couleur violette pour une rapide identification par les employés et les clients.

DEUTSCH

Legen sie die Kleinen Utensilien fest, die sie Verwenden, um Essen Zuzubereiten und zu Servieren, das Keine Allergiestoffe Enthält. In Lila Für Eine Schnelle Identifizierung Seitens Mitarbeiter und Kunden.

EN EL MUNDO / IN THE WORLD /
DANS LE MONDE / IN DER WELT



3%

DE LA POBLACIÓN GENERAL PADECE ALGUN TIPO DE ALERGIA /
OF THE GENERAL POPULATION SUFFER FROM SOME TYPE OF ALLERGY /
DE LA POPULATION SOUFFRE D'UNE QUELCONQUE ALLERGIE /
DER BEVÖLKERUNG LEIDEN AN IRGEND EINER ALLERGIE

EN EUROPA / IN EUROPE /
DANS EUROPE / IN EUROPA

17M

3,5M < 25

AÑOS / YEARS OLD /
ANS / JAHRE

DE PERSONAS PADECEN ALERGIA ALIMENTARIA /
PEOPLE SUFFER FROM FOOD ALLERGIES /
D'INDIVIDUS SOUFFRENT D'UNE ALLERGIE ALIMENTAIRE /
PERSONEN LEIDEN AN EINER NAHRUNGSMITTELALLERGIE

EN ESPAÑA / IN SPAIN /
EN ESPAGNE / IN SPANIEN

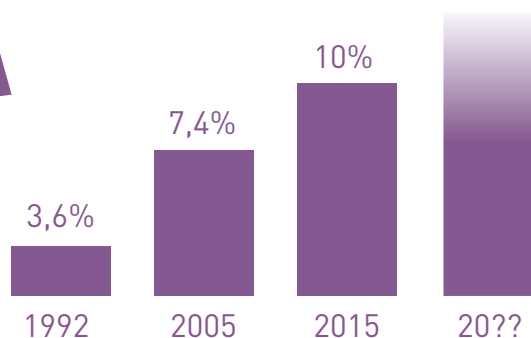

PORCENTAJE DE
PERSONAS ALÉRGICAS /

ALLERGIC
PEOPLE RATE /

POURCENTAGE DE
PERSONNES ALLERGIQUES /

ANTEIL DER ALLERGIKER

LA OFERTA GASTRONÓMICA HA CRECIDO UN /
THE GASTRONOMIC RANGE ON OFFER HAS GROWN BY/
L'OFFRE GASTRONOMIQUE A AUGMENTÉ DE /
DIE ZUNAHME DES GASTRONOMISCHEN ANGEBOT IST VON

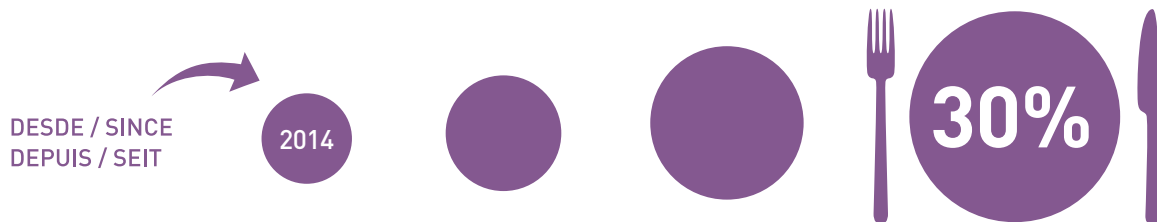

7/10

REACCIONES ALÉRGICAS
OCURREN FUERA DE CASA* /

ALLERGIC REACTIONS OCCUR
OUTSIDE THE HOME* /

RÉACTIONS ALLERGIQUES
SE PRODUISENT HORS DE CHEZ SOI* /

ALLERGISCHE REAKTIONEN TRETEN
AUßERHALB DES EIGENEN ZUHAUSES AUF*



EN LA ESCUELA / IN SCHOOLS /
À L'ÉCOLE / IN DER SCHULE

4-7%

20%

DE LOS NIÑOS TIENE ALÉRGIA ALIMENTARIA /
OF THE CHILDREN HAVE FOOD ALLERGIES /
DES ENFANTS SOUFFRENT D'UNE ALLERGIE ALIMENTAIRE /
DER KINDER LEIDEN AN EINER NAHRUNGSMITTELALLERGIE

DE LAS REACCIONES OCURRE EN LOS COLEGIOS /
OF THE REACTIONS OCCUR IN PRIMARY SCHOOLS /
DES RÉACTIONS SE PRODUISENT EN MILIEU SCOLAIRE /
DER REAKTIONEN TRETEN IN DEN SCHULEN AUF

*La Comisión Europea ha reconocido que siete de cada diez reacciones alérgicas graves ocurren cuando la gente come fuera de casa.

* The European Commission has recognised that seven out of ten serious allergic reactions occur when people are outside their homes.

* La Commission européenne a constaté que sept réactions allergiques sur dix se produisent quand on mange hors de chez soi.

* Die Europäische Kommission hat festgestellt, dass sieben von zehn allergischen Reaktionen auftreten, wenn die Menschen außerhalb des eigenen Zuhauses essen.

ABC Cataluña. "Aumentan las quejas e intoxicaciones en restaurantes por falsos menús sin gluten". Publicación 09 de mayo de 2017
http://www.abc.es/espana/catalunya/abci-aumentan-quejas-intoxicaciones-restaurantes-falsos-menús-sin-gluten-201705091619_noticia.html

55179 Kit antialérgico / Allergen-Free Kit /
Kit anti allergique / Ständerset Anti Allergie

CONTIENE / CONTAINS /
CONTIENT / ENTHÄLT

REF



55179

1



1527-C80

Caja de almacenamiento de comida /
Food storage box /
Boîte d'stockage /
Lebensmittel Aufbewahrungsbox

REF	cm
1527-C80	38,1 x 50,8 x 17,8



1500-C80

Tapa /
Lid /
Couvercle /
Deckel

REF	cm
1500-C80	39,7 x 57,2 x 6,4



4780980

Pinza monobloc Kool-Touch® /
One-Piece utility tong Kool-Touch® /
Pince buffet Kool-Touch® /
Einteilige, farblich gekennzeichnete
Kool-Touch® gewellter Servierzangen

REF	L cm
4780980	24



6414080

Cuchara servicio /
Solid spoons /
Cuillères à servir pleines /
Massiv Löffel

REF	L cm
6414080	35



4808880

Espátula de acero inoxidable hoja lisa /
Solid, stainless Steel Turner /
Pelle pleine, inox /
Edelstahl-Pfannenwender für schwere
Beanspruchung

REF	cm	L cm
4808880	21 x 7,5	42



4980280

Cacillo monobloc Kool-Touch® /
One-Piece ladle Kool-Touch® handle /
Louche monobloc manche Kool-Touch® /
Monoblock Schöpflöffel Kool-Touch® Griffen

REF	L cm	ml
4980280	25	60



P120.124

Sartén antiadherente /
Non-stick fry pan /
Poêle anti-adhésive /
Antihafte Bratpfanne

REF	Ø cm	H cm
P120.124	24	4,5



47003

Batidor con mango antiadherente /
Whisk with anti-slip handle /
Fouet avec poignée anti-crispation /
Rührbesen Antirutschgriff

REF	L cm	MANGO/HANDLE/QUEUE /GRIF L cm
47003	30,5	12

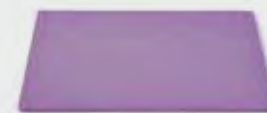

P911.407

Tabla de corte /
Cutting Board /
Planche à découper /
Schneidbretter

REF	mm	H mm
P911.407	400 x 300	20

1527-C80 Caja de almacenamiento de comida /
Food storage box /
Boîte d'stockage /
Lebensmittel Aufbewahrungsbox



REF	L cm	
1527-C80	38,1 x 50,8 x 17,8	6

1500-C80 Tapa /
Lid /
Couvercle /
Deckel



REF	L cm	
1500-C80	39,7 x 57,2 x 6,4	6
1522-C80*	40,3 x 54,9 x 2,5	6

*Tapa ahuecada / Cover, recessed /
Couvercle concave / Hohler Deckel

VER PRODUCTOS EN / SEE PRODUCTS ON / VOIR PRODUITS EN PAGE / SIEHE PRODUKTE IN

CACEROLA ALTA SIN TAPA /
SAUCE POT WITHOUT LID /
BRAISIÈRE SANS COUVERCLE /
HOHE KASSEROLLE OHNE DECKEL



P. 30

BATIDORA DE VASO DE ALTA POTENCIA /
HI-POWER BLENDER /
BLENDER HAUTE PUISSANCE /
HOCHLEISTUNGSSTANDMIXER



P. 320

SARTÉN ANTIADHERENTE /
NON-STICK FRY PAN /
POÊLE ANTI-ADHÉSIVE /
ANTIHAFT BRATPFANNE



P. 56

TABLA DE CORTE /
CUTTING BOARD /
PLANCHE À DÉCOUPER /
SCHNEIDBRETTER

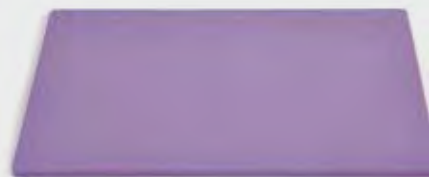

P. 104

4761965

Bol Servicio doble pared cuadrado /
Square Double-Wall Insulated Serving Bowl /
Bol double paroi /
Quadratische, farbige, doppelwandig isolierte Servierschüsseln



REF	cm	Lts	☐
4761965	13.9 x 13.9 x 7	0,7	6
4763265	18.4 x 18.4 x 8.7	1,7	12
4763465	21.6 x 21.6 x 10.8	3,0	6
4763565	25.8 x 25.8 x 13	4,9	4
4763765	29.9 x 29.9 x 15	7,8	3

4658765

Bol Servicio doble pared redondo /
Round Double-Wall Insulated Serving Bowl /
Bol ronde double paroi /
Runde farbige, doppelwandig isolierte Servierschüsseln



REF	cm	Lts	☐
4658765	14,4 x 7,6	0,7	6
4659065	18,4 x 10,3	1,6	6
4659165	24,1 x 12,9	3,2	6
4659265	30 x 16,5	6,6	3
4656965	35 x 17,5	9,6	2

4780680

Pinza monobloc Kool-Touch® /
One-Piece utility tong Kool-Touch® /
Pince buffet Kool-Touch® /
Einteilige, farblich gekennzeichnete
Kool-Touch® gewellter Servierzangen



REF	L cm	☐
4780680	15,0	12
4780980	24,0	12
4781280	30,5	12
4781680	40,5	12
478091280*	24,0	12

6433480

Spoodle® monobloc redondo /
One-Piece Round Spoodle® /
Spoodle® monobloc ronde /
Monoblok Rundschalen Spoodle®



REF	L cm	ml	☐
6433480	34,0	120	12
6433580	34,5	150	12

6432480

Spoodle® monobloc redondo perforado /
One-Piece Round Perforated Spoodle® /
Spoodle® monobloc ronde perforé /
Monoblok Perforierten Rundschalen Spoodle®



REF	L cm	ml	☐
6432480	34	120	12

4980280

Cacillo monobloc Kool-Touch® /
One-Piece leadle Kool-Touch® handle /
Louche monobloc manche Kool-Touch® /
Monoblock Schöpflöffel Kool-Touch® Griffen



REF	L cm	ml	☐
4980280	25	60	12
4980480	32	120	12

6414080 Cuchara servicio /
Solid spoons /
Cuillères à servir pleines /
Massiv Löffel



REF	L cm	
6414080	35	12

6414280 Cuchara servicio perforada /
Perforated spoons /
Cuillères à servir perforées /
Perforiert Löffel



REF	L cm	
6414280	35	12

4808780 Espátula de acero inoxidable hoja lisa /
Solid, stainless steel Turner /
Pelle pleine, inox /
Edelstahl-Pfannenwender für
schwere Beanspruchung



REF	cm	L cm	
4808780	15 x 7,5	34,5	12
4808880	21 x 7,5	42,0	12

47147 Porcionador / Disher /
Cuillère de service / Portionierer



REF	Ø cm	L cm	ml	
47147	4	21	22	12

47400 Porcionador / Disher /
Cuillère de service / Portionierer



REF	TIPO/TYPER	L cm	ml	
47400	Estándar	20,0	22	12
47378	Extendido	23,5	22	12

47002 Batidor con mango antiadherente /
Whisk with anti-slip handle /
Fouet avec poignée anti-crispation /
Rührbesen Antirutschgriff



REF	L cm	L mango cm	
47002	25,5	12	12
47003	30,5	12	12
47004	35,5	12	12
47005	40,5	12	12
47006	45,5	12	12

INFORMACIÓN VALIOSA / VALUABLE INFO /
INFORMATION UTILE / WERTVOLLE INFORMATION



EN EL MUNDO HAY / IN THE WORLD, THERE ARE /
DANS LE MONDE, IL Y A / AUF DER WELT EXISTIEREN

+170

ALIMENTOS QUE CAUSAN REACCIONES /
FOODSTUFFS THAT CAN CAUSE REACTIONS /
ALIMENTS QUI CAUSENT DES RÉACTIONS /
NAHRUNGSMITTEL, DIE REAKTIONEN HERVORRUFEN















14

**GRUPOS DE ALÉRGENOS
EN EL REGLAMENTO /**

**GROUPS OF ALLERGENS
IN THE REGULATIONS /**

**GROUPES D'ALLERGÈNES
DANS LE RÈGLEMENT /**

**ALLERGENGRUPPEN SIND
IN DEN BESTIMMUNGEN
AUFGENOMMEN**

 Sésamo / Sesame Sésame / Sesam	 Moluscos / Molluscs Mollusques / Mollusken
 Mostaza / Mustard Moutarde / Senf	 Altramuces / Lupin beans Lupins / Lupinen
 Apio / Celery Céleri / Sellerie	 Sulfitos / Sulphites Sulfites / Sulfite
 Gluten / Gluten Gluten / Gluten	 Cacahuets / Peanuts Cacahuètes / Erdnüsse
 Crustáceos / Crustaceans Crustacés / Krustentiere	 Soja / Soya Soja / Soja
 Huevos / Eggs Œufs / Eier	 Leche / Milk Lait / Milch
 Pescado / Fish Poisson / Fisch	 Frutos de cáscara / Nuts Fruits à coque / Schalenfrüchte

Parlamento Europeo y del Consejo. Reglamento (UE) N° 1169/2011. 25 de octubre de 2011. Pg 43 http://www.aecosan.msssi.gob.es/AECO-SAN/web/seguridad_alimentaria/subdetalle/futura_legislacion.htm

8



90%

ALIMENTOS REPRESENTAN EL /
FOODSTUFFS REPRESENT /
ALIMENTS RASSEMBLENT /
NAHRUNGSMITTEL STELLEN

DE TODAS LAS REACCIONES ALÉRGICAS ALIMENTARIAS /
OF ALL THE FOOD ALLERGY REACTIONS /
DE TOUTES LES RÉACTIONS ALLERGIQUES ALIMENTAIRES /
ALLER ALLERGISCHEN REAKTIONEN AUF NAHRUNGSMITTEL

Healthy Futures (NEA). "Alergias a los alimentos: lo que el personal de la escuela debe saber". 2012. Pg 5 http://healthyfutures.nea.org/wp-content/uploads/2015/04/foodallergybook_spanish.pdf



ESPAÑOL

FRANÇAIS

- Es de obligado cumplimiento informar al consumidor sobre los alérgenos que puedan contener los alimentos, aunque las personas que puedan estar afectadas de dichas alergias o intolerancias no se hayan identificado como tales.

- El reglamento vigente hace recaer la responsabilidad al establecimiento si un consumidor padece una reacción alérgica, pudiéndose enfrentar a sanciones económicas..

- Il est oblig   d'informer les consommateurs   propos des allerg nes que les aliments peuvent contenir, m me si les personnes qui peuvent subir une allergie n'ont pas manifest  son intol rance.

- Selon la r glementation en vigueur, si un consommateur subit une r action allergique, l' tablissement est responsable et peut faire face   des p nalit s.

ENGLISH

DEUTSCH

- It's mandatory to inform customers about allergen that food may contain, even if they are not allergic to such allergen.

- According to food regulations, bars & restaurants are liable in case of allergic reaction to its customers, and incur to expensive fines.

- Es ist zwingend notwendig Verbraucher  ber die in dem Lebensmittel erhaltenen Allergene zu informieren, obwohl die Menschen, die von diesen Allergien oder Unvertr glichkeiten betroffen, sich nicht als solche identifiziert haben.

- Die derzeitige Verordnung legt die Beweislast festzustellen, ob ein Verbraucher eine allergische Reaktion leidet, wirtschaftliche Sanktionen begegnen zu k nnen.

VER PRODUCTOS EN / SEE PRODUCTS ON / VOIR PRODUITS EN PAGE / SIEHE PRODUKTE IN

GASTRONORM POLIPROPILENO /
POLYPROPYLENE GASTRONORM /
GASTRONORME POLYPROPYL NE /
POLYPROPYLEN GASTRONORM



P. 172

GUÍA SELECCIÓN RALLADORES / GRATERS SELECTION GUIDE / GUIDE SÉLECTION RAPÊS / AUSWAHLÜBERSICHT REIBEN

	DOBLE NAVAJA / RIBON / TRANCHANTS / DOPPELKLINGEN	TIRAS LARGAS / LARGE SHAVER / LARGE COUPE / LANGE STREIFEN	FINO / FINE / FIN / FEIN	MEDIO / MEDIUM / MOYEN / MITTEL	GRUESO / EXTRA COARSE / GROS GRAINS / GROB	DUAL / DUAL / DOUBLE / DOPPEL
ZANAHORIA / CARROT / CAROTTE / KAROTTEN	✓	✓				✓
CEBOLLA / ONION / OIGNON / ZWIEBEL	✓			✓		✓
AJO / GARLIC / AIL / KNOBLAUCH			✓			
CHOCOLATE SCHOKOLADE	✓		✓	✓	✓	✓
CITRICOS / CITRUS / CITRON / ZITRONEN		✓	✓	✓		
PATATA / POTATO / POMME DE TERRE / KARTOFFEL	✓	✓				
MANZANA / APPLE / POMME / APFEL	✓	✓			✓	
QUESO DURO / HARD CHEESE / FROMAGE / HARTKÄSE	✓		✓	✓	✓	✓
QUESO BLANDO / SOFT CHEESE / FROMAGE / WEICHKÄSE	✓				✓	
NUEZ / NUT / NOIX / NÜSSE			✓	✓		✓
PIMIENTO / PEPPER / POIVRON / PFEFFER			✓	✓		✓
TOMATE / TOMATO / TOMATO / TOMATEN				✓	✓	

P328 Rallador / Grater / Râpe / Reibe

INOX - ST/STEEL
ROSTFREIER STAHL



Ref. P328.600

REF	CARAS / SIDES / FACES / SEITEN	cm	H cm	
P328.020	4	9 x 6,5	20,8	12
P328.023	4	10,5 x 8	23,3	12
P328.600	6	14,5 x 11	22,0	12

P391 Rallador nuez moscada de acero inox / St/Steel nutmeg grater /
Râpe à muscade en acier inox / Rostfreie Muskatnussreibe



REF	
P391.000	12

P3221 Rallador acero inoxidable "slim" con mango / St/Steel "slim" grater with handle /
Râpe inoxydable "slim" avec queue / Rostfreie Reibe "schmal" mit Griff

Ralladores de acero inoxidable. Mangos ergonómicos. Borde antideslizante
St/Steel graters. Ergonomic and soft touch handles. Non-slip rubber end
Râpes en acier inoxydable. Poignée ergonomique. Extrémité anti-dérapant
Rostfreie Reiben. Ergonomische Griffe. Antirutschrand.

IDEA!

ESPECIAL CÍTRICOS /
IDEAL FOR CITRUS /
IDÉAL POUR AGRUMES /
IDEAL FÜR ZITRUSFRÜCHTE

**BEST
SELLER**

REF	cm	
P322.101	39,5 x 3,5	1
P322.102	39,5 x 3,5	1
P322.103	39,5 x 3,5	1
P322.104	39,5 x 3,5	1



REF. P322.104
Fino
Fine
Fin
Fein



REF. P322.101
Dual
Dual
Double
Doppel



REF. P322.103
Medio
Medium
Moyen
Medium



REF. P322.102
Doble navaja
Ribon
Tranchants
Zwei Klingen

P3222 Rallador acero inoxidable "wide" con mango / St/Steel "wide" grater with handle /
Râpe inoxydable "wide" avec queue / Rostfreie Reibe "breit" mit Griff

Ralladores de acero inoxidable. Mangos ergonómicos. Borde antideslizante
St/Steel graters. Ergonomic and soft touch handles. Non-slip rubber end
Râpes en acier inoxydable. Poignée ergonomique. Extrémité anti-dérapant
Rostfreie Reiben. Ergonomische Griffe. Antirutschrand.

IDEA!

ESPECIAL CÍTRICOS /
IDEAL FOR CITRUS /
IDÉAL POUR AGRUMES /
IDEAL FÜR ZITRUSFRÜCHTE

REF	cm	
P322.201	31,5 x 7,3	1
P322.202	31,5 x 7,3	1
P322.203	31,5 x 7,3	1
P322.204	31,5 x 7,3	1



REF. P322.204
Fino
Fine
Fin
Fein



REF. P322.201
Tiras largas
Large shaver
Large coupe
Lange Streifen



REF. P322.202
Doble navaja
Ribon
Tranchants
Zwei Klingen



REF. P322.203
Grueso
Extra coarse
Gros grains
Grob

UTENSILIOS /
UTENSILS /
USTENSILES

4.1 UTENSILIOS DE COCINA / KITCHEN UTENSILS /
USTENSILES DE CUISINE / KÜCHENUTENSILIEN

Colador doble malla en acero inoxidable /
St/Steel double mesh strainer /
Passoire double maille en acier inox /
P374 Doppelmaschiges Sieb rostfrei



REF	Ø cm	L cm	LUZ DE MALLA / MESH SIZE / MAILLAGE / MASCHENWEITE mm	
P374.013	13	30	1-3	72
P374.015	15	32	1-3	72
P374.018	18	34	1-3	72
P374.020	20	38	1-3	72
P374.026	26	58,5	1,6-3	72

UTENSILIOS DE COCINA / KITCHEN UTENSILS /
USTENSILES DE CUISINE / KÜCHENUTENSILIEN

Colador doble malla en acero inoxidable. Reforzado /
St/Steel double mesh strainer. Reinforced /
Passoire double maille en acier inox. Renforcé /
P375 Doppelmaschiges Sieb rostfrei und verstärkt

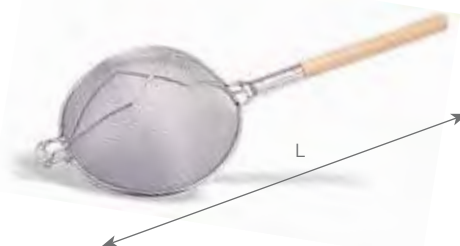

REF	Ø cm	L cm	LUZ DE MALLA / MESH SIZE / MAILLAGE / MASCHENWEITE mm	
P375.030	30	79,0	1,040	1
P375.035	35	86,5	1,040	1

Colador 1/2 bola reforzado en acero inox /
St/Steel reinforced 1/2 ball colander /
Passoire ronde renforcé en acier inox /
P324 Halbkugeliges Sieb rostfrei und verstärkt

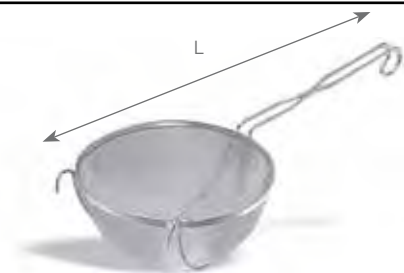

REF	Ø cm	L cm	LUZ DE MALLA / MESH SIZE / MAILLAGE / MASCHENWEITE mm	
P324.013	13	36	0,530	12
P324.016	16	40	0,530	12
P324.019	19	42,5	0,530	12
P324.022	22	49	0,530	12
P324.025	25	55,5	0,530	12

Colador cónico en acero inoxidable /
St/Steel conical strainer /
Passoire conique en acier inox /
P348 Konisches Sieb rostfrei und verstärkt

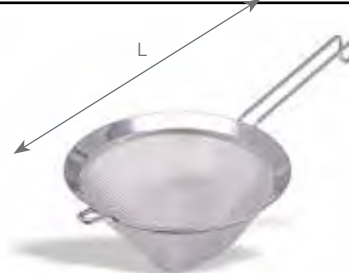

REF	Ø cm	L cm	LUZ DE MALLA / MESH SIZE / MAILLAGE / MASCHENWEITE mm	
P348.008	8	22,5	0,700	96
P348.010	10	24,5	0,700	96
P348.012	12	31,5	0,700	96
P348.015	15	35	0,700	96
P348.018	18	40,5	0,700	72

Colador media bola en acero inox /
St/Steel hemispherical strainer /
Passoire demi-sphérique en acier inox /
P325 Halbrundes Sieb rostfrei

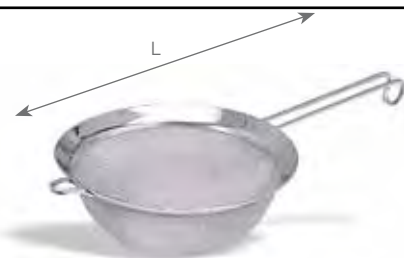

REF	Ø cm	L cm	LUZ DE MALLA / MESH SIZE / MAILLAGE / MASCHENWEITE mm	
P325.008	8	22,5	0,700	96
P325.010	10	25,2	0,700	96
P325.012	12	32,5	0,700	96
P325.015	15	40,2	0,700	72
P325.018	18	42,5	0,700	72
P325.020	20	44,5	0,700	72

Colador bayeta / Cotton strainer /
P373 Passe-bouillon / Textilsieb



Acero inoxidable y algodón
St/Steel and cotton
Acier inoxydable et cotton
Rostfrei und Baumwolle

REF	L cm	
P373.020	20	6
P373.024	24	6
P373.028	28	6

P303 Colador chino / Conical colander /
Chinois / Spitzsieb



REF	Ø cm	H cm	
P303.016	16,8	34,8	12
P303.018	18,6	38,4	12
P303.020	21,1	39,7	12
P303.022	23,2	44,0	12
P303.024	25,1	46,0	12
P303.026	27,2	47,8	12

P970 Soporte para chino o embudo /
Stand for chinese colander or funnel /
Support pour chinois ou entonnoir /
Ständer für Spitzsieb und Trichter



REF	Ø cm	H cm	
P970.000	16	19	1

P347 Colador chino con malla /
Conical colander with wire gauze /
Chinois à gaze /
Spitzsieb mit Maschen



REF	Ø cm	LUZ DE MALLA / MESH SIZE / MAILLAGE / MASCHENWEITE mm	
P347.020	20	0,700	12
P347.024	24	0,700	12

P3032 Triángulo / Triangle / Triangle / Dreieck

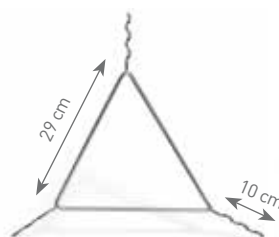

Triángulo equilátero
Equilateral triangle
Triangle équilatéral
Gleichseitiges Dreieck

REF	L cm	
P303.200	29	1

VER PRODUCTOS EN / SEE PRODUCTS ON / VOIR PRODUITS EN PAGE / SIEHE PRODUKTE IN

**EMBUDO DOSIFICADOR /
CONFECTIONERY FUNNEL /
ENTONNOIR DOSEUR /
DOSIERUNGSTRICHTER**

P. 253



P308 Ecurridera / Conical colander /
Passoire conique / Konischer Seiher

INOX - ST/STEEL
EDELSTAHL
18/10

EXTRA RESISTENTE /
HEAVY DUTY /
EXTRA RÉISTANT /
EXTRA-RESISTENT



REF	Ø cm	H cm	
P308.030	30	16,0	1
P308.035	35	16,5	1
P308.040	40	18,0	1
P308.045	45	19,5	1
P308.050	50	22,5	1

P109 Ecurridera con aro / Conical colander /
Passoire conique / Konischer Seiher mit Ring

ALUMINIO /
ALUMINIUM



REF	Ø cm	H cm	
P109.030	30	14,5	1
P109.035	35	16,5	1
P109.040	40	17,5	1
P109.045	45	20,0	1
P109.050	50	22,5	1

P300 Ecurridera inox con base / st/steel colander with stand /
Passoire inox sur pied / Seiher rostfrei mit Ständer

INOX - ST/STEEL
ROSTFREIER STAHL



REF	Ø cm	H cm	
P300.024	24	11,50	1
P300.030	30	13,50	1

P3003 Ecurridera de malla / Mesh conical colander /
Passoire à maille / Maschensieb

INOX - ST/STEEL
ROSTFREIER STAHL



P300325
P300335



P300340

REF	Ø cm	H cm	
P300.325	25	12	1
P300.335	35	18	1
P300.340	40	18	1

P321 Colador / Colander /
Passoire / Seiher

INOX - ST/STEEL
EDELSTAHL
18/10



REF	Ø cm	
P321.020	20	1
P321.022	22	1
P321.024	24	1
P321.026	26	1

P313 Pasapurés / Vegetable sieve /
Moulin à légumes / Passiermaschine



REF	Ø cm	Ø FILTRO / FILTER / FILTRE / FILTER cm	☐
P313.025	25	11,5	1
P313.030	30	14,5	1



Con 2 discos inox. intercambiables /
With 2 St/Steel interchangeable cutters /
Avec 2 coupeurs inox interchangeables /
Mit 2 auswechselbaren Scheiben rostfrei

P3131 Pasapurés / Vegetable sieve /
Moulin à légumes / Passiermaschine



REF	Ø cm	Ø FILTRO / FILTER / FILTRE / FILTER cm	☐
P313.126	26	16,5	1
P313.132	32	16,5	1



Con 2 discos inox. intercambiables /
With 2 St/Steel interchangeable cutters /
Avec 2 coupeurs inox interchangeables /
Mit 2 auswechselbaren Scheiben rostfrei

P945 Harinero / Flour bin /
Tamis à farine / Mehlsieb



REF	cm	☐
P945.037	37 x 26,5 x 18	1
P945.050	50 x 26,5 x 18	1
P945.051	50 x 33 x 18	1

P3135 Pasapurés / Potato ricer /
Presse-purés / Kartoffelpresse



REF	Ø cm	L cm	☐
P313.500	9	30,5	1

P958 Gancho acero inoxidable 1p. / St/Steel hook 1p. /
Crochet inox 1p. / Haken rostfrei 1 St.



Precio caja 10 unidades
Price 10 units box
Prix colis 10 unités
Preis Kiste 10 Teile

REF	L cm	Ø mm	☐
P958.010	10	4	10
P958.012	12	5	10
P958.014	14	6	10
P958.016	16	6	10
P958.018	18	6	10

P954 Embudo con filtro extraíble /
Funnel with removable filter /
Entonnoir avec filtre extractible /
Trichter mit herausnehmbarem Filter



REF	Ø A cm	H B cm	☐
P954.013	13	2,6	1
P954.015	15	2,6	1
P954.020	20	3,2	1
P954.025	25	3,2	1



P868 Dispensador a presión / Squeeze dispenser / Distributeur à pression / Einzeldosierer



REF	COLOR	●	ml	H cm	Ø cm	☐
P868.001	●	●	240	18,0	5	12
P868.002	●	●	360	21,0	5	12
P868.003	●	●	720	24,5	5	12
P868.004	●	●	240	18,0	5	12
P868.005	●	●	360	21,0	5	12
P868.006	●	●	720	24,5	5	12
P868.007*	○	○	240	18,0	5	12
P868.008*	○	○	360	21,0	5	12
P868.009*	○	○	720	24,5	5	12

* Transparente / Clear / Transparent

2808-13 Dispensador a presión / Squeeze dispenser / Distributeur à pression / Einzeldosierer



2808-13
2812-13

4916-13
4924-13
4932-13

REF	COLOR	●	ml	H cm	Ø cm	☐
2808-13	○	○	240	18,4	5,0	12
2812-13	○	○	350	18,4	6,0	12
4916-13	○	○	470	18,7	7,5	12
4924-13	○	○	710	26,0	7,3	12
4932-13	○	○	950	26,4	8,3	12

Transparente / Clear / Transparent

2208-1354 Dispensador a presión doble / Twin squeeze dispenser /
Distributeur à pression double / Zweifachdosierer



REF	COLOR	●	ml	H cm	Ø cm	☐
2208-1354	○	●	200	18,0	5	12

Transparente / Clear / Transparent

IDEA!

Ideal para decoración
Ideal for dish presentation
Idéal pour decoration
Ideal für die Dekoration



3316-13191 Dispensador a presión triple / Tri squeeze dispenser /
Distributeur à pression triple / Dreifachdosierer



3316-13191

3316-13
3332-13

REF	COLOR	●	ml	H cm	Ø cm	☐
3316-13	○	○	470	18,7	7,5	12
3332-13	○	○	950	25,4	8,6	12
3316-13191	○	●	500	18,0	5	12

Transparente / Clear / Transparent

IDEA!

Ideal para decoración
Ideal for dish presentation
Idéal pour decoration
Ideal für die Dekoration



2908 Dispensador a presión con tapón cierre rosca / Squeeze dispenser with open-close system cap /
Distributeur pressurisation a/capuchon d'ouverture-fermeture / Druckdosierer mit Schraubdeckel



Ref. 2908-13

Ref. 5324-13

REF	ml	H cm	Ø cm	
2908-13	240	18,4	5,1	1
2912-13	350	18,4	6,0	1
5324-13	710	24,4	7,3	1

Transparente / Clear / Transparent



26120 Dispensador a presión con tapón / Squeeze dispenser with cap /
Distributeur pression avec capuchon / Druckdosierer mit Deckel



Ref. 26120-13

Ref. 26240-13

Ref. 26320-13

REF	ml	H cm	Ø cm	
26120-13	350	16,2	6,2	1
26240-13	710	22,5	7,5	1
26320-13	950	22,9	8,6	1

Transparente / Clear / Transparent



4961 Especieros / Dredgers / Saupoudreuses / Streuer



Ref. 4961-13191

Ref. 4961-1332

Ref. 4961-1308

Ref. 4961-1301

REF	ml	Ø cm AGUJEROS / HOLES / TROUS / LÖCHER	Ø cm	H cm	
4961-13191	470	0,14	7,3	16	1
4961-1332	470	0,25	7,3	16	1
4961-1308	470	0,46	7,3	16	1
4961-1301	470	0,94	7,3	16	1

Transparente / Clear /
Transparent

P946 Especieros / Dredgers / Saupoudreuses / Streuer



A

B

C

D

REF	Ø cm	H cm	Ø mm	
A P946.001	7	9,6	-	12
B P946.002	7	9,6	2	12
C P946.003	7	9,6	3	12
D P946.004	7	9,6	4	12

Especiero "A" con malla
Dredger "A" with mesh
Saupoudreuse "A" maillée
Streuer "A" mit Maschen

Con tapón de plástico
With plastic cover
Avec couvercle en plastique
Mit Plastideckel



UTENSILIOS /
UTENSILS /
USTENSILES

P870 Molde huevo sandwich redondo /
Round egg ring /
Moule à oeuf rond /
Runde Sandwicheierform



REF	Ø cm	H cm	
P870.000	8,5	11,0	1

P871 Molde huevo sandwich cuadrado /
Squared egg mould /
Moule à oeuf carré /
Rechteckige Spiegeleierform



REF	cm	H cm	
P871.000	8,5 x 8,5	11,0	1

P905 Aplastacarnes inox forjado /
Solid St/Steel meat beater /
Aplatisseur inox forgé /
Solider Fleischstampfer rostfrei



REF	Ø cm	Kg	L cm	
P905.015	10	1,5	14	1

P942 / P943 Aplastadora carne /
Meat tenderizer /
Aplatisseur à viande /
Fleischstampfer



REF	Ø cm	Kg	L cm	
P942.000	9,5	0,750	28,5	1
P943.000	9,5	0,750	28,5	1

P334

Alcuza / Oil pourer / Huilière / Ölkanne



REF	Lts	
P334.050	0,50	1
P334.100	1,00	1
P334.200	2,00	1

Barra de notas de aluminio /
Aluminium check minder /
Barre porte-bons en aluminium /
Aluminiumleiste für Notizen

P873



REF	L cm	H cm	
P873.045	45	5,0	1
P873.060	60	5,0	1
P873.090	90	5,0	1

P323 Tenedor / fork / Fourchette / Spiess



REF	L cm	
P323.050	50	5

P944 Escamador / Fish scaler /
Ecailleur / Fischentschupper



P94009

Remo acero inoxidable / St/Steel mixing paddle /
Spatule géante inoxydable / Rührpaddel rostfrei



REF	PALA / PEEL / PELLE / BLATT CM	L cm	
P940.090	12 x 19	90	1
P940.120	16 x 19,5	120	1

Rascador con mango aluminio /
Grill scraper aluminium /
Raclette à plancha /
Schaber mit Aluminiumgriff

P940



REF	cm	
P940.000	44,5 x 12 x 12,7	1
RE940.001	12,7 x 7,7	1

P8180 Cepillo metálico / Metallic brush /
Brosse métallique / Metallbürste



REF	L cm	
P818.000	27	1

REF	L cm	
P944.000	23,5	1

REDCO® PUJADAS®

AMPLIA GAMA DE PROCESADORES DE ALIMENTOS MANUALES

CORTA VERDURAS Y FRUTAS
HASTA 11 VECES MÁS RÁPIDO QUE EL CORTE A MANO
FÁCIL INTERCAMBIO DE LAS CUCHILLAS
LIMPIEZA RÁPIDA Y FÁCIL

WIDE RANGE OF MANUAL FOOD PROCESSORS

CUTS BOTH FRUIT AND VEGETABLES
SPEED UP YOUR WORK 11 TIMES FASTER THAN HAND CUTTING
EASY-TO-REMOVE INTERCHANGEABLE BLADES
EASY TO CLEAN

LARGE GAMME D'APPAREILS MANUELS DE TRANSFORMATION DES ALIMENTS

COUPE LES LÉGUMES ET LES FRUITS
JUSQU'À 11 FOIS PLUS RAPIDE QUE LORSQUE VOUS COUPEZ À LA MAIN
COUTEAUX FACILEMENT INTERCHANGEABLES
NETTOYAGE RAPIDE ET FACILE

GROSSE AUSWAHL AN HANDLICHEN SCHNEIDEMASCHINEN

GEEIGNET FÜR OBST UND GEMÜSE
11MAL SCHNELLER ALS HANDSCHNEIDEN
MÜHELOSE AUSTAUSCHBARKEIT DER KLINGEN
SCHNELLE UND EINFACHE REINIGUNG

DADOS Y BASTONCILLOS /
DICE & STICKS /
CUBES ET BÂTONNETS /
WÜRFEL UND STÄBCHEN



REBANADA /
SLICE /
TRANCHES /
SCHEIB



GAJOS /
WEDGE /
QUARTIERS /
ZERTEILER



SACACORAZONES /
CORE /
ÉVIDOIR /
ENTKERNER



PROCESADORES MANUALES DE ALIMENTOS /
MANUAL FOOD PROCESSORS /
APPAREILS MANUELS DE TRANSFORMATION DES ALIMENTS /
MANUELLE KÜCHENMASCHINEN

NUEVO MODELO /
NEW MODEL /
NOUVEAU MODÈLE /
NEUES MODELL



*VELOCIDADES / SPEEDS /
VITESSES / GESCHWINDIGKEITEN

	3x	3x	5x
 Limones / Lemons Citrons / Zitronen			
 Limas / Limes Citrons verts / Limonen			
 Naranjas / Oranges Oranges / Orangen			
 Tomates / Tomatoes Tomates / Tomaten	✓	✓	
 Cebollas / Onions Oignons / Zwiebeln	✓	✓	✓
 Apio / Celery Céleri / Stangensellerie	✓	✓	
 Pimientos / Peppers Poivrons / Paprikaschoten	✓	✓	
 Patatas / Potatoes Pommes de terre / Kartoffeln	✓	✓	
 Manzanas / Apples Pommes / Äpfel	✓ 4x	✓ 4x	
 Peras / Pears Poires / Birnen	✓ 4x	✓ 4x	
 Lechuga / Lettuce Laitue / Kopfsalat			✓
 Pimientos / Bell peppers Poivrons / Paprikaschoten	✓		✓
 Pepino / Cucumbers Concombres / Gurken			✓

*Veces más rápido que cortar a mano.
Faster than cutting by hand.
Fois plus rapide qu'une coupe à la main.
Schneller als das Schneiden von Hand.

Reduzca el tiempo de mano de obra /
Reduce labor time /
Réduisez le temps de travail /
Reduzieren Sie Ihre Arbeitszeit



11x	2,5x	3x	3x	5x
	✓	✓	✓	
	✓	✓	✓	
	✓	✓	✓	
		✓	✓	✓
	✓			
	✓	✓	✓	
		✓	✓	
		✓	✓	
✓				

UTENSILIOS /
UTENSILS /
USTENSILES



55457 Cortador-Rebanador de sobremesa grande / Big size tabletop dicer & slicer /
Grand Coupe légumes en tranches et cubes / Größer Tisch Würfelschneider und - hobel für Arbeitsflächen



InstaCut™ 5.0
Sobremesa /
Tabletop /
A poser /
Arbeitsflächen

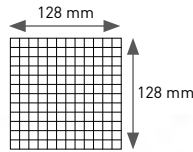

**NUEVO MODELO /
NEW MODEL /
NOUVEAU MODÈLE /
NEUES MODELL**

ADAPTABLE A / ADJUSTABLE TO /
ADAPTABLE À / GEEIGNET FÜR

DENTRO / INSIDE /
DANS / INNERHALB (MAX)
1/3 100 mm
1/4 150 mm
1/6 150 mm

FUERA / OUTSIDE /
EXTÉRIEUR / AUßERHALB (MAX)
1/1 200 mm



Con ventosas de agarre en la base.
With suction base.
Avec ventouse d'accrochement à la base.
Mit Saugfüßen.

REF	TIPO/TYPE	CORTE / CUT COUPE / SCHNITT mm	
DADOS - BASTONCILLOS / DICE & STICKS / CUBES ET BÂTONNETS / WÜRFEL UND STÄBCHEN			
55457		● 6,4	1
55458		9,5	1
55459		12,7	1
REBANADA / SLICE / TRANCHES / SCHEIB			
55460		● 6,4	1

Los artículos marcados con cada punto de color son compatibles entre ellos /
Items marked with the same coloured dot are compatible with each other /
Les articles marqués d'un point de couleur sont compatibles /
Die mit den einzelnen Farbpunkten gekennzeichneten Artikel sind miteinander kombinierbar.



*H 50,8 cm ABIERTO / OPEN / OUVERT / OFFEN
*H 47 cm CERRADO / CLOSED / FERMÉ / GESCHLOSSEN



UTENSILIOS /
UTENSILES /
USTENSILES

ASA EN T, BLOQUE DE EMPUJE Y CUCHILLA /
T-HANDLE, PUSHER BLOCK AND BLADE /
POIGNÉE EN T, BLOC DE POUSSÉE ET LAME /
T-GRIFF, DRUCKBLOCK UND MESSER

TIPO/TYPE REF mm

DADOS - BASTONCILLOS / DICE & STICKS / CUBES ET BÂTONNETS / WÜRFEL UND STÄBCHEN

		● 55483	6,4
		55484	9,5
		55485	12,7

REBANADA / SLICE / TRANCHES / SCHEIB

		● 55486	6,4
--	--	---------	-----

SECCIONES / SECTION /
QUARTIERS / STÜCK

GAJOS / WEDGE / QUARTIERS / ZERTEILER

		● 55490	6
		55491	8
		55492	10
		● 55493	12

SACACORAZONES / CORE / ÉVIDOIR / ENTKERNER

		● 55494	6
		55495	8

SÓLO CUCHILLA DE REEMPLAZO /
REPLACEMENT BLADE ONLY /
LAME DE RECHANGE SEULE /
NUR ERSATZMESSER

REF

	● 55470
	55471
	● 55472

	● 55473
--	---------

	● 55477
	55478
	55479
	● 55480

	● 55481
	55482

15000 **Cortador-Rebanador de sobremesa pequeño / Small size tabletop dicer & slicer /**
Coupe légumes en tranches et cubes de table / Kleiner Tisch Würfelschneider und - hobel für Arbeitsflächen

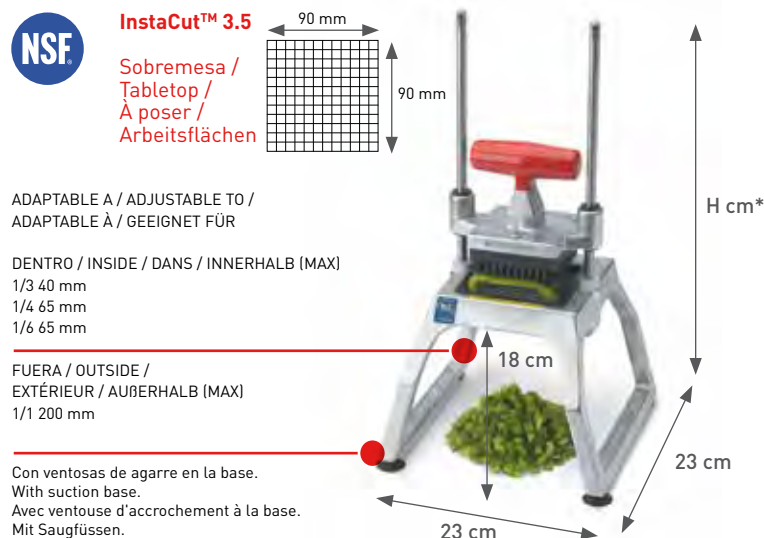

REF	TIPO/TYPE	CORTE / CUT COUPE / SCHNITT mm	
DADOS - BASTONCILLOS / DICE & STICKS / CUBES ET BÂTONNETS / WÜRFEL UND STÄBCHEN			
15000		6,4	1
15001		9,5	1
15002		12,7	1

REF	TIPO/TYPE	SECCIONES / SECTION / QUARTIERS / STÜCK	
GAJOS / WEDGE / QUARTIERS / ZERTEILER			
15003		4	1
15005		6	1
15006		8	1
15007		10	1
15008		12	1

*H 45,7 cm ABIERTO / OPEN / OUVERT / OFFEN
*H 43,5 cm CERRADO / CLOSED / FERMÉ / GESCHLOSSEN



15016 **Cortador-Rebanador de pared / Wall mount dicer & slicer /**
Coupe légumes fixation murale / Tischwürfelschneider und - hobel zur Wandmontage



REF	TIPO/TYPE	CORTE / CUT COUPE / SCHNITT mm	
DADOS - BASTONCILLOS / DICE & STICKS / CUBES ET BÂTONNETS / WÜRFEL UND STÄBCHEN			
15016		6,4	1
15017		9,5	1

ASA EN T, BLOQUE DE EMPUJE Y CUCHILLA / T-HANDLE, PUSHER BLOCK AND BLADE /
POIGNÉE EN T, BLOC DE POUSSÉE ET LAME / T-GRIFF, DRUCKBLOCK UND MESSER

SÓLO CUCHILLA DE REEMPLAZO /
REPLACEMENT BLADE ONLY /
LAME DE RECHANGE SEULE /
NUR ERSATZMESSER

Ref. 15000 - 15010

Ref. 15016-15024

TIPO/TYPE	REF	mm
DADOS - BASTONCILLOS / DICE & STICKS / CUBES ET BÂTONNETS / WÜRFEL UND STÄBCHEN		
	15059	6,4
	15060	9,5
	15061	12,7
	15085	6,4 x 12,7

SECCIONES / SECTION / QUARTIERS / STÜCK	REF	mm
GAJOS / WEDGE / QUARTIERS / ZERTEILER		
	15050	4
	15052	6
	15053	8
	15054	10
	15055	12

SACACORAZONES / CORE / ÉVIDOIR / ENTKERNER	REF	mm
	15058	8

REF	
	15062
	15063
	15064
	15086

REF	
	15065
	15067
	15068
	15069
	15070

REF	
	15072

47713 Cortador de patatas / Potato cutter /
Coupe-pommes de terre / Pommes-Frites-Schneider

Scan me



47713
47714
47715

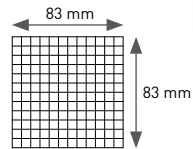

47703**

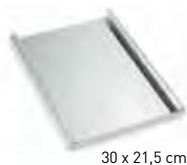

45682
^^No se incluyen los tornillos.
Screws not included.
Vis non fournies.
Schrauben nicht inbegriffen.

30 x 21,5 cm

REF	TIPO/TYPE	CORTE / CUT COUPE / SCHNITT mm	
DADOS - BASTONCILLOS / DICE & STICKS / CUBES ET BÂTONNETS / WÜRFEL UND STÄBCHEN			
47713		7	1
47714		10	1
47715		11	1
REF	TIPO/TYPE	SECCIONES / SECTION / QUARTIERS / STÜCK	
GAJOS / WEDGE / QUARTIERS / ZERTEILER			
47703**		8	1
REF			
SOPORTE PARED / WALL HANGER BRACKET / SUPPORT DE SUSPENSION MURALE / WANDAUFHÄNGUNG			
45682^^			1

*Y 87,6 cm H 58,4 cm ABIERTO / OPEN / OUVERT / OFFEN
*Y 45,0 cm H 35,6 cm CERRADO / CLOSED / FERMÉ / GESCHLOSSEN

SOLO CUCHILLA DE REEMPLAZO / REPLACEMENT BLADE ONLY /
LAME DE RECHANGE SEULE / NUR ERSATZMESSER

REF	TIPO/TYPE	CORTE / CUT COUPE / SCHNITT mm	
DADOS - BASTONCILLOS / DICE & STICKS / CUBES ET BÂTONNETS / WÜRFEL UND			
45751-1		7	1
45749-1		10	1
45750-1		11	1

Agujeros para tornillos en la base de las patas para el montaje permanente en mesas o paredes.
Screw holes on base of legs for permanent mounting to table or wall.
Trous à vis sur la base des pieds pour fixation permanente sur une table ou un mur.
Schraubenlöcher im Boden der Standfüße zur dauerhaften Befestigung an Tisch oder Wand.

**Se ofrecen cuchillas y piezas adicionales.
Extra blades and parts available.
Lames et pièces supplémentaires disponibles.
Zusätzliche Messer und Teile erhältlich.

P975 Cortador de patatas fritas / French fry cutter / Coupe frites / Pommesschneider

Acero inox
Stainless steel
Acier inoxydable
Rostfreier Stahl

ADAPTABLE A / ADJUSTABLE TO /
ADAPTABLE Ä / GEEIGNET FÜR

FUERA / OUTSIDE /
EXTÉRIEUR / AUßERHALB (MAX)
1/1 65 mm

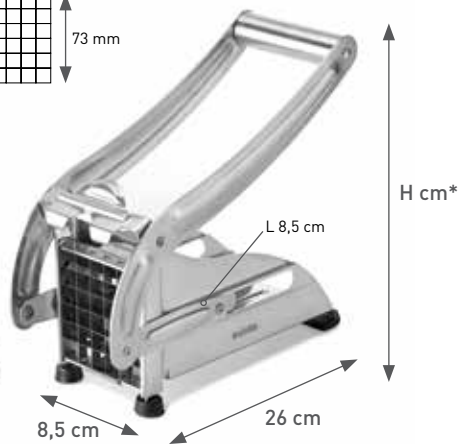
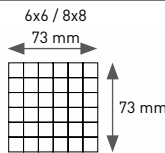

REF	CORTE / CUT COUPE / SCHNITT mm	AGUJEROS / HOLES / Trous / LÖCHER	
P975.000	12 / 9	36 / 64	1

*H 30 cm ABIERTO / OPEN / OUVERT / OFFEN
*H 13 cm CERRADO / CLOSED / FERMÉ / GESCHLOSSEN

CUCHILLA DE REEMPLAZO / REPLACEMENT BLADE ITEM /
LAME DE RECHARGE / ERSATZMESSER

REF	CORTE / CUT COUPE / SCHNITT mm	AGUJEROS / HOLES / Trous / LÖCHER	
RE 975.001	12	36 (6 x 6)	1
RE 975.002	9	64 (8 x 8)	1

400N Cortador de lechuga / Salad cutter / Coupe-Salade / Salatschneider

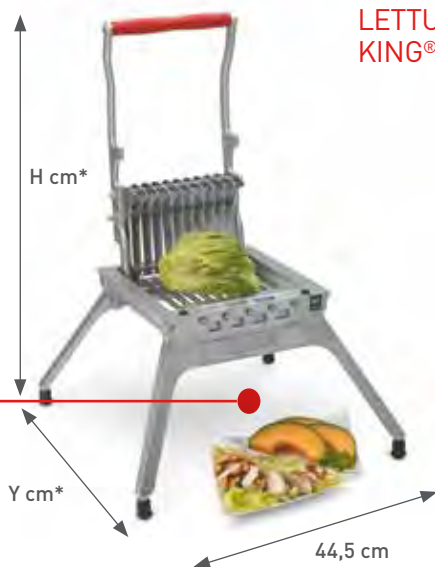

LETTUCE
KING® I

ADAPTABLE A /
ADJUSTABLE TO /
ADAPTABLE À /
GEEIGNET FÜR (MAX)
1/1 100 mm
1/2 150 mm



REF	TIPO/ TYPE	CORTE / CUT COUPE / SCHNITT mm	CUCHILLAS / BLADES / LAMES / MESSER	
400N		4,8	37	1
403N		6,4	28	1
402NC		9,5	19	1
401N		19,0	10	1

*Y 48,3 cm H 45,7 cm ABIERTO / OPEN / OUVERT / OFFEN
*Y 59,1 cm H 43,5 cm CERRADO / CLOSED / FERMÉ / GESCHLOSSEN

CONJUNTO DE CUCHILLAS / BLADE ASSEMBLY /
JEU DE LAMES / MESSEREINHEIT

REF	PARA / FOR / POUR / FÜR	CORTE / CUT COUPE / SCHNITT mm	CUCHILLAS / BLADES / LAMES / MESSER	
DADOS - BASTONCILLOS / DICE & STICKS / CUBES ET BÂTONNETS / WÜRFEL UND STÄBCHEN				
435	400N	4,8	37	1
485	403N	6,4	28	1
484C	402NC	9,5	19	1
434	401N	19,0	10	1

Corte un cuarto de cabeza de lechuga a la vez.
Cut a quarter head of lettuce at a time.
Coupez un quart de tête de laitue à la fois.
Schneidet jeweils ein Salatkopfviertel.

5x **Más rápido / Faster**

4400N Cortador de lechuga / Salad cutter / Coupe-Salade / Salatschneider

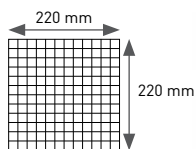

ADAPTABLE A /
ADJUSTABLE TO /
ADAPTABLE À /
GEEIGNET FÜR (MAX)
1/1 200 mm
1/2 200 mm



LETTUCE
KING® IV

REF	TIPO/TYPE	CORTE / CUT COUPE / SCHNITT mm	
DADOS - BASTONCILLOS / DICE & STICKS / CUBES ET BÂTONNETS / WÜRFEL UND STÄBCHEN			
4400N		25,4 x 25,4	1

*Y 43,2 cm H 81,3 cm ABIERTO / OPEN / OUVERT / OFFEN
*Y 47 cm H 54,9 cm CERRADO / CLOSED / FERMÉ / GESCHLOSSEN

CONJUNTO DE CUCHILLAS / BLADE ASSEMBLY /
JEU DE LAMES / MESSEREINHEIT

REF	TIPO/TYPE	CORTE / CUT COUPE / SCHNITT mm	
DADOS - BASTONCILLOS / DICE & STICKS / CUBES ET BÂTONNETS / WÜRFEL UND STÄBCHEN			
4408		25,4 x 25,4	1

No oscurece la lechuga.
Does not bruise the lettuce.
N'abime pas la laitue.
Vermeidet Verletzungen der
empfindlichen Salatblätter

11x **Más rápido / Faster**



403NH Rebanadora de frutas y verduras / Fruit & vegetable slicer / Coup-fruit et légumes / Obstschneider

Scan me



ADAPTABLE A /
ADJUSTABLE TO /
ADAPTABLE À /
GEEIGNET FÜR (MAX)
1/2 65 mm

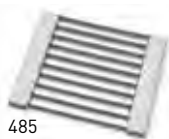

485



REF	TIPO/ TYPE	CORTE / CUT COUPE / SCHNITT mm	CUCHILLAS / BLADES / LAMES / MESSER	
SACACORAZONES / CORE / ÉVIDOIR / ENTKERNER				
403NH		6,4	28	1

*Y 33,6 cm H 50,8 cm ABIERTO / OPEN / OUVERT / OFFEN
*Y 55,7 cm H 23,3 cm CERRADO / CLOSED / FERMÉ / GESCHLOSSEN

SOLO CUCHILLA DE REEMPLAZO / REPLACEMENT BLADE ONLY /
LAME DE RECHANGE SEULE / NUR ERSATZMESSER

REF	TIPO/ TYPE	CORTE / CUT COUPE / SCHNITT mm	CUCHILLAS / BLADES / LAMES / MESSER	
SACACORAZONES / CORE / ÉVIDOIR / ENTKERNER				
485		6,4	28	1

Área de corte completa de 12,7 cm para frutas grandes.
Full 12.7 cm cutting area optimal for large fruits.
Longueur de coupe de 13 cm optimale pour les fruits volumineux.
Großer 12,5-cm-Schneidbereich eignet sich optimal für große Obstsorten.

No oscurece la fruta durante el corte, reduciendo así los desechos.
Prevents bruising of fruit during cutting, reducing food waste.
N'abîme pas le fruit durant la coupe, réduisant le gaspillage.
Verhindert Quetschverletzungen am Obst beim Schneiden und reduziert die Verschwendung.

500N Cortador de cebollas / Onion cutter / Coupe-onions / Zwiebelschneider



ADAPTABLE A / ADJUSTABLE TO /
ADAPTABLE À / GEEIGNET FÜR
(MAX)
1/1 65 mm
1/2 65 mm
1/3 100 mm
1/4 100 mm
1/6 100 mm



P510
13 x 6 cm

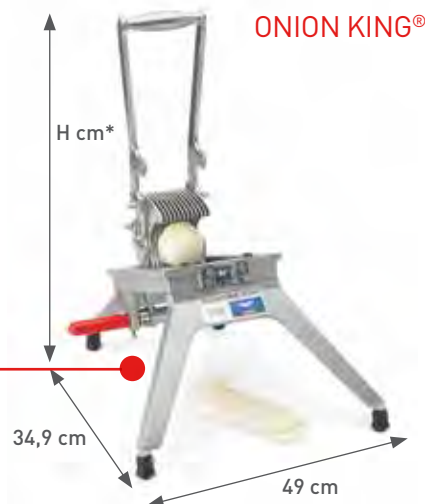

ONION KING®

REF	TIPO/ TYPE	CORTE / CUT COUPE / SCHNITT mm	CUCHILLAS / BLADES / LAMES / MESSER	
SACACORAZONES / CORE / ÉVIDOIR / ENTKERNER				
500N		4,8	13	1
501N		6,4	11	1
502N		9,5	7	1
503N		12,7	6	1

*H 49 cm ABIERTO / OPEN / OUVERT / OFFEN
*H 39,4 cm CERRADO / CLOSED / FERMÉ / GESCHLOSSEN

CONJUNTO DE CUCHILLAS / BLADE ASSEMBLY /
JEU DE LAMES / MESSEREINHEIT

REF	PARA / FOR / POUR / FÜR	CORTE / CUT COUPE / SCHNITT mm	CUCHILLAS / BLADES / LAMES / MESSER	
509	500N	4,8	13	1
511	501N	6,4	11	1
510	502N	9,5	7	1
512	503N	12,7	6	1

Espesor de rebanada exacto.
Exact slice thickness.
Épaisseur de tranches exacte.
Exakte Scheibendicke.



15604 Cortador cebollas en flor / Bloom onion cutter / Coupe onion en fleur / Zwiebelschneider in Blumenform



Scan me



INSTABLOOM® II



REF	SECCIONES / SECTION / QUARTIERS / STÜCK	
15604	24	1

*H 76,2 cm ABIERTO / OPEN / OUVERT / OFFEN
*H 48,3 cm CERRADO / CLOSED / FERMÉ / GESCHLOSSEN

CONJUNTO DE CUCHILLAS / BLADE ASSEMBLY /
JEU DE LAMES / MESSEREINHEIT

REF	SECCIONES / SECTION / QUARTIERS / STÜCK	
15601	24	1

Fabricación de aluminio moldeado altamente resistente.
Constructed from heavy duty cast aluminum.
En aluminium coulé ultra-robuste.
Aus stark belastbarem Aluminiumguss.

Tiene cuchillas de acero inoxidable con bordes de precisión.
Features precision edged stainless steel blades.
Lames inox de précision.
Mit präzisionsgefertigten Edelmessern.

Con ventosas de agarre en la base.
With suction cup base.
Avec ventouse d'accrochement à la base.
Mit Saugfüßen.



15601

4.3 UTENSILIOS DE COCINA / KITCHEN UTENSILS / USTENSILES DE CUISINE / KÜCHENUTENSILIEN

PROCESADORES MANUALES DE ALIMENTOS / MANUAL FOOD PROCESSORS / APPAREILS MANUELS DE TRANSFORMATION DES ALIMENTS / MANUELLE KÜCHENMASCHINEN

606N Cortador seccionador de tomates y cítricos / Tomato and lemon wedger / Diviseur à tomates et agrumes / Wedger Schneider



WEDGEMASTER™

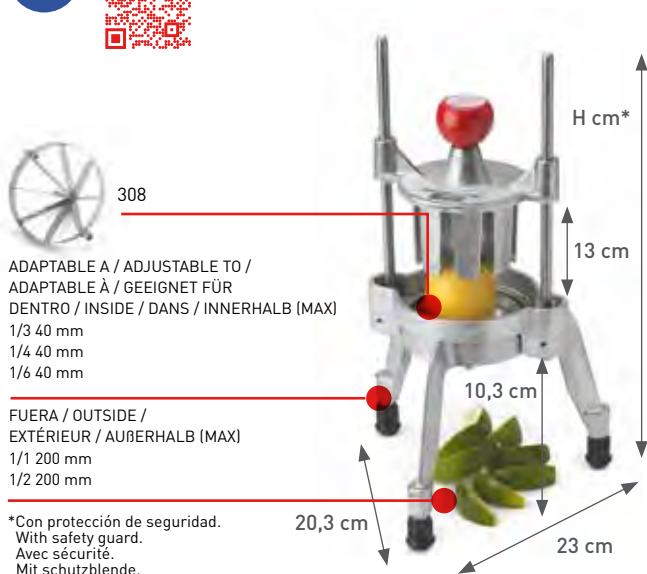

REF	SECCIONES / SECTION / QUARTIERS / STÜCK	SE VENDE CON CUCHILLAS / SHIPS WITH BLADES / DESCRIPTION DE LA COUPE / MESSER IM LIEFERUMFANG ENTHALTEN	
606N	6	P306/P336	1
808N	8	P308/P338	1
808SG*	8	P308/P338	1

CONJUNTO DE CUCHILLAS / BLADE ASSEMBLY / JEU DE LAMES / MESSEREINHEIT

REF	TIPO/TYPE	SECCIONES / SECTION / QUARTIERS / STÜCK	
GAJOS / WEDGE / QUARTIERS / ZERTEILER			
306		6	1
308		8	1
SACACORAZONES / CORE / ÉVIDOIR / ENTKERNER			
336		6	1
338		8	1

*H 40,6 cm ABIERTO / OPEN / OUVERT / OFFEN
*H 40,3 cm CERRADO / CLOSED / FERMÉ / GESCHLOSSEN



700-1 Cortador seccionador de tomates y cítricos / Tomato and lemon wedger / Diviseur à tomates et agrumes / Wedger Schneider



WEDGEMASTER™ II



REF	TIPO/TYPE	SECCIONES / SECTION / QUARTIERS / STÜCK	
700-1		6	1
700-4		8	1

CONJUNTO DE CUCHILLAS / BLADE ASSEMBLY / JEU DE LAMES / MESSEREINHEIT

REF	TIPO/TYPE	SECCIONES / SECTION / QUARTIERS / STÜCK	
GAJOS / WEDGE / QUARTIERS / ZERTEILER			
704		4	1
706		6	1
708		8	1
712		12	1



*H 40,6 cm ABIERTO / OPEN / OUVERT / OFFEN
*H 38,7 cm CERRADO / CLOSED / FERMÉ / GESCHLOSSEN

Fabricación de material de policarbonato para lavavajillas. Constructed of dishwasher safe polycarbonate material. En polycarbonate qui passe au lave-vaisselle. Aus spülmaschinenfestem Polycarbonatmaterial hergestellt.

Compatible / Kompatibel



P937 Máquina multi-usos / Versatil machine / Machine universel / Universelle Maschine



REF	H cm	
P937.000	80	1

REF	H cm	
RE937.001	Recambio cortador patatas / French fry cutter spare part / Coupe frites (pièce rechange) / Austauschbarer Pommesschneider	1
RE937.002	Recambio cortador manzanas / Apple cutter spare part / Coupe pommes (pièce rechange) / Austauschbarer Apfelschneider	1
RE937.003	Recambio exprimidor zumos / Juicer spare part / Press fruits (pièce rechange) / Austauschbarer Entsafter	1



47704 Exprimidor de zumos / Juice extractor / Extracteur de jus / Saftpresse



REF	
47704	1

Mejor acción de palanca para sacar la máxima cantidad de jugo.
Superior leverage for maximum juice output.
Effet de levier supérieur pour presser un maximum de jus.
Hervorragende Hebelwirkung garantiert maximale Entsaftung.

Base de hierro fundido esmaltado altamente resistente.
Heavy-duty enamel-coated cast iron base.
Base en fonte émaillée ultra-solide.
Für starke Beanspruchung ausgelegter, emaillierter Gusseisensockel.

Las patas de goma evitan los deslizamientos durante el uso.
Rubber feet assure no-slide use.
Pieds en caoutchouc antidérapants.
GummifüÙe verhindern ein jegliches Verrutschen.



P9759 Cortador de tomates / Tomatoes slicer / Coupe tomates / Tomatenschneider



REF	CORTE / CUT COUPE / SCHNITT mm	cm	
P975.900	6,4	39 x 21,5 x 20	1
RE975.901	6,4	25 x 6,8	1



5x
Más rápido / Faster

RE975.901
Cuchilla / Blade / Lame / Klingen

0643N Cortador de tomates / Tomatoes slicer / Coupe tomates / Tomatenschneider

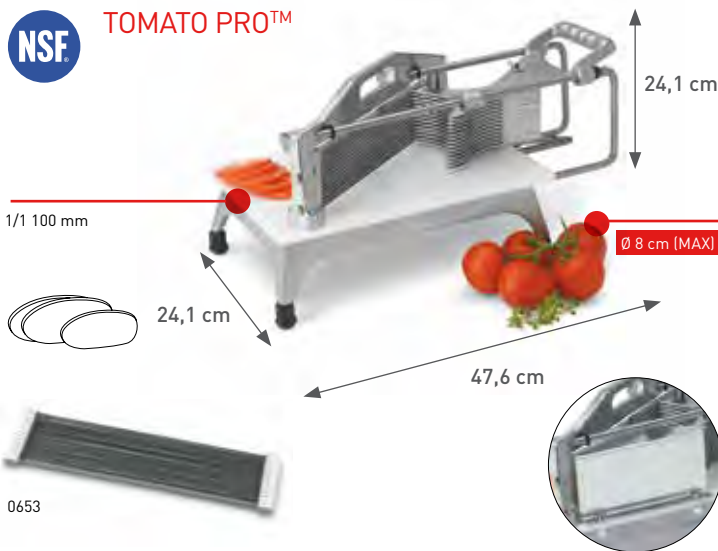

REF	CORTE / CUT COUPE / SCHNITT mm	CUCHILLAS / BLADES / LAMES / MESSER	
0643N*	4,8	15	1
0644N**	6,4	11	1
0643SGN*^	4,8	15	1
0644SGN***^	6,4	11	1

CUCHILLA DE REEMPLAZO / REPLACEMENT BLADE ITEM /
LAME DE RECHARGE / ERSATZMESSER

REF	CORTE / CUT COUPE / SCHNITT mm	CUCHILLAS / BLADES / LAMES / MESSER	
*0653	4,8	15	1
**0654	6,4	11	1

^Con protección de seguridad. Permite sujeción a la mesa.
With safety guard. Holds firmly on countertop.
Avec sécurité. Fixation ferme sur la table.
Mit Schutzblende. Hält fest auf dem Tisch.

5x
Más rápido / Faster

15105 Cortador de tomates / Tomatoes slicer / Coupe tomates / Tomatenschneider

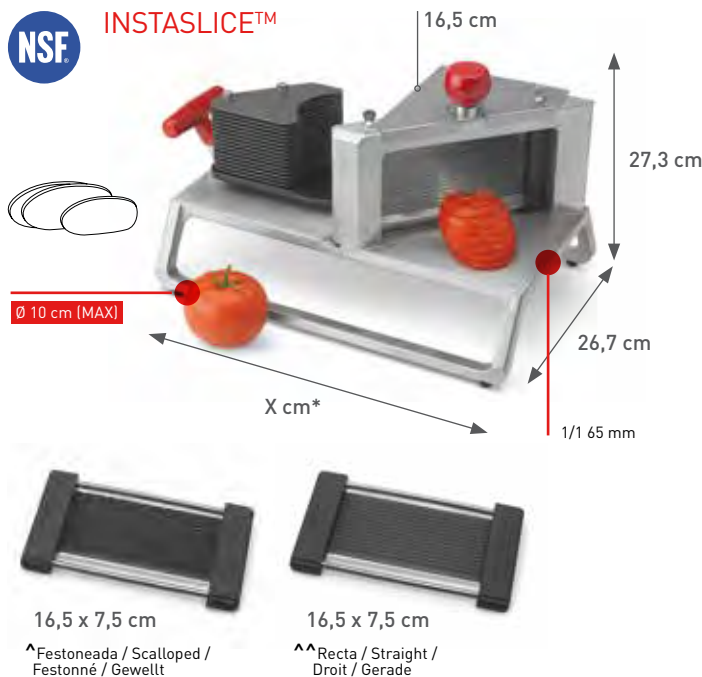

REF	TIPO/TYPE	CORTE / CUT COUPE / SCHNITT mm	CUCHILLAS / BLADES / LAMES / MESSER	
15105^		4,8	16	1
15205^^		4,8	16	1
15103^		6,4	12	1
15104^		9,5	8	1

*X 44,5 cm ABIERTO / OPEN / OUVERT / OFFEN
*X 40,6 cm CERRADO / CLOSED / FERMÉ / GESCHLOSSEN

CUCHILLA DE REEMPLAZO / REPLACEMENT BLADE ITEM /
LAME DE RECHARGE / ERSATZMESSER

REF	TIPO/TYPE	CORTE / CUT COUPE / SCHNITT mm	CUCHILLAS / BLADES / LAMES / MESSER	
15115^		4,8	16	1
15209^^		4,8	16	1
15113^		6,4	12	1
15114^		9,5	8	1

Conjuntos de cuchillas encajables para facilitar el reemplazo.
"Pop-in pop out" blade assemblies for easy replacement.
Lames qui s'installent et se sortent par détente pour un remplacement facile.
Messer lassen sich zum einfachen Auswechseln leicht einsetzen und herausnehmen.

5x
Más rápido / Faster

Resistente a la corrosión.
Corrosion resistant.
Résistant à la corrosion.
Korrosionsbeständig.

1811 Cortador en cubos / Cube cutter / Coupe en cubes / Würfelschneider



CUBEKING™

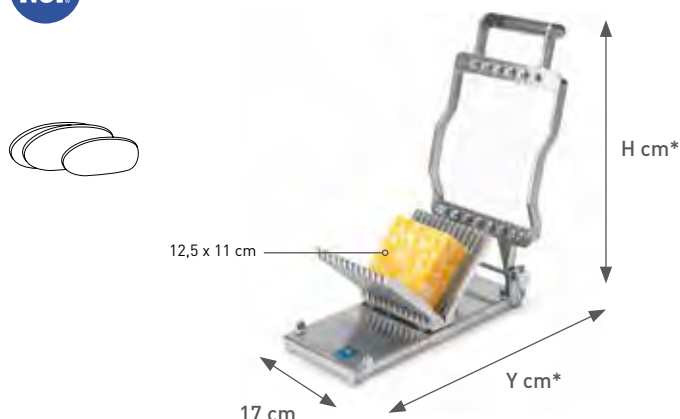

REF	CORTE / CUT COUPE / SCHNITT mm	
1811	19,1	1
1812	9,5	1

*Y 33 cm *H 34 cm ABIERTO / OPEN / OUVERT / OFFEN
*Y 32 cm *H 11 cm CERRADO / CLOSED / FERMÉ / GESCHLOSSEN

JUEGO DE ALAMBRES DE REPUESTO / REPLACEMENT WIRE KIT /
KIT DE FIL DE RECHANGE / DRAHT-ERSATZKIT

REF	
1823	1

Produce cubos, palillos y bloques cuadrados o rectangulares de queso.
Produce uniform cheese cubes, sticks, and square or rectangular blocks.
Produisez des dés, bâtonnets et blocs carrés ou rectangulaires de fromage.
Erzeugen Sie einheitlich große Käsewürfel, Stäbchen und quadratische
oder rechteckige Blöcke.

1837 Cortador quesos / Cheese cutter / Coupe fromage / Käse Drahtschneider



CHEESE BLOCKER™



REF	
1837	1

*Y 74,3 cm H 57,5 cm ABIERTO / OPEN / OUVERT / OFFEN
*Y 55,8 cm H 31,1 cm CERRADO / CLOSED / FERMÉ / GESCHLOSSEN

JUEGO DE ALAMBRES DE REPUESTO / REPLACEMENT WIRE KIT /
KIT DE FIL DE RECHANGE / DRAHT-ERSATZKIT

REF	
1838	1

Admite quesos en bloques de hasta 20 kg y circulares de hasta 15 kg.
Accommodates cheese blocks up to 20 kg and wheels up to 15 kg.
Compatible avec les blocs de fromage de 20 kg max. et les meules de 15 kg max.
Für Käseblöcke von bis zu 20 kg und Räder von bis zu 15 kg.

Incrementos de medición de 1,3 cm en la placa frontal y la base.
1,3 cm measuring increments on front plate and base.
Incréments de mesure de 1,3 cm sur la plaque avant et la base.
1,3-cm-Skalenstufen auf Frontplatte und Boden.

1853 Abridor de ostras / Oyster opener / Ouvre huîtres / Austeröffner



OYSTER KING™



REF	
1853	1

*Y 26,7 cm H 38,1 cm ABIERTO / OPEN / OUVERT / OFFEN
*Y 37,5 cm H 10,8 cm CERRADO / CLOSED / FERMÉ / GESCHLOSSEN

CUCHILLA DE REEMPLAZO / REPLACEMENT BLADE ITEM /
LAME DE RECHARGE / ERSATZMESSER

REF	
5382	1

P9640 Abrelatas industrial acero inoxidable / St/Steel can opener /
Ouvre-boîtes professionnel en acier inoxydable / Industrieller Edelstahl Dosenöffner



REF	H cm	
P964.001	60	1

CUCHILLA DE RECAMBIO / KNIFE (SPARE PART) /
COUTEAU (PIÈCE DE RECHANGE) / AUSTAUSCHKLINGE

REF	
RE964.100	1

RODILLO DE RECAMBIO / WHEEL (SPARE PART) /
ROULEAU (PIÈCE DE RECHANGE) / AUSTAUCHRAD

REF	
RE964.200	1

55 cm

Altura máxima de las latas.
Maximum height of cans.
Hauteur maximale des boîtes.
Maxmale Höhe der Dosen.

P390 Cortahuevos guitarra de acero inox /
St/Steel egg slicer /
Coupe-oeuf en acier inox /
Eierschneider rostfrei



REF	cm	
P390.000	7,7 x 9,4	1

P3901 Cortahuevos doble uso / 2 way egg cutter /
Coupe-oeuf 2 utilisations / 2 Weg Eierschneider



REF	cm	
P390.100	11,5 x 9,5 x 3,5	1

P610 Cortador y descorazonador manzanas /
Apple cutter & corer /
Vide et coupe pommes /
Apfelschneider und Entherzer



REF	Ø cm	
P610.000	8,5	1

Cuchilla en acero inoxidable y marco en aluminio de fundición
St/Steel blades with cast aluminium frame
Lames inox et manche en aluminium fonté
Messer aus rostfreiem Stahl und Rahmen aus Aluminiumguss

P938 Prensa ajos / Garlic Press /
Presse-ail / Knoblauchpresse



REF	
P938.000	1

Aluminio fundición
Cast aluminium
Fonté d'aluminium
Aluminiumguss

P9755 Mandolina corte "V" / "V" shaped mandoline slicer /
"V" mandoline / "V" Gemüsehobel

PLÁSTICO / PLASTIC /
PLASTIQUE / PLASTIK

REF	CORTE / CUT COUPE / SCHNITT mm	CUCHILLAS / BLADES / LAMES / MESSER	
P975.500	4 / 7	24 / 12	1

Incluye: 2 cuchillas + 3 guías plástico grosor (1 mm / 2 mm / 3 mm) /
Includes: 2 julienne blades + 3 thickness guides (1 mm / 2 mm / 3 mm) /
Comprend: 2 lames julienne + 3 guides épaisseur (1 mm / 2 mm / 3 mm) /
Inklusive: 2 Klingen + 3 Schneideplatten (1 mm / 2 mm / 3 mm)

Pies goma antideslizantes.
Non-slip rubber feet.
Pieds en caoutchouc antidérapants.
Rutschfeste GummifüÙe.

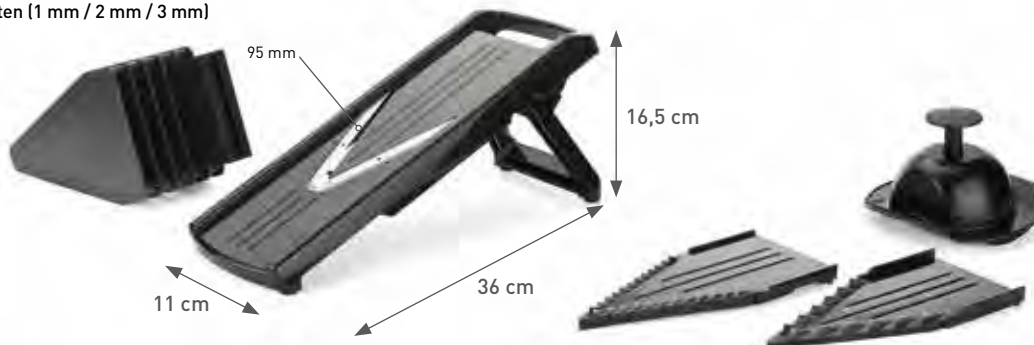
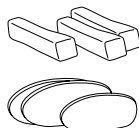

9756 Mandolina / Mandoline / Mandoline / Mandoline

ACERO INOXIDABLE / ST/STEEL /
ACIER INOXYDABLE / ROSTFREIER STAHL

REF	CORTE / CUT COUPE / SCHNITT mm	CUCHILLAS / BLADES / LAMES / MESSER	
P975.600	4 / 9	23 / 11	1

Incluye: cuchilla giratoria + regulador de espesor corte (3, 6 y 9 mm) /
Includes: rotating blades + thickness regulator (3, 6 and 9 mm) /
Comprend: lames tournantes + regulateur épaisseur (3, 6 et 9 mm) /
Inklusiv: drehbare Klinge + Breitenregulierer (3, 6 und 9 mm)

Rebanada, rebanada ondulada y bastoncillos.
Slice, wavy slice and sticks.
Tranches, ondulé tranches et bâtonnets.
Scheib, crinkle scheid und stäbchen.

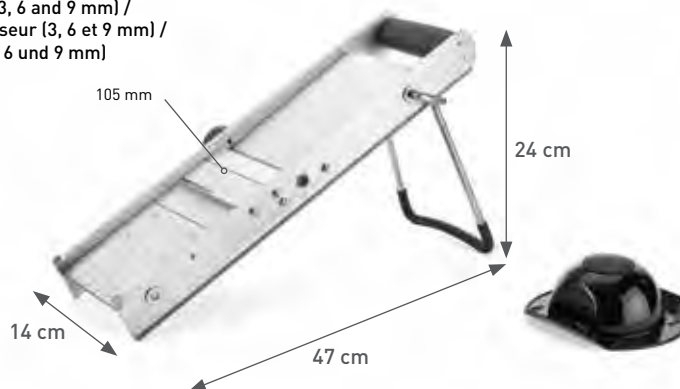
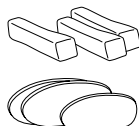

1400 Descorazonador de tomates / Tomato corer / Permet d'ôter le coeur de la tomate / Tomatenentkerner

TOMATO KING®

REF	
1400	144



Dientes de acero inoxidable.
Stainless steel teeth.
Dents en inox.
Edelstahlzähne.

Paquete a granel / Bulk pack /
Paquet en vrac / Großpackung

15149 Gel lubricante sanitario / Sanitary gel lubricant / Gel lubrifiant sanitaire / Medizinisches Gleitgel

PETROL GEL

REF	ml	
15149	118	1





UTENSILIOS /
UTENSILS /
USTENSILLES



PESCADO CRUDO
RAW FISH
POISSON CRU
ROHER FISCH



CARNE CRUDA
RAW MEAT
VIANDE CRU
ROHES FLEISCH



CARNE CRUDA DE AVE
RAW POULTRY & CHIKEN
VIANDE CRU ET VOLAILLES
ROHES GEFLÜGEL



ANTIÁLÉRGICO
ALLERGEN-FREE
ANTI ALLERGIQUE
ANTI ALLERGIE



PAN Y LÁCTEOS
BAKERY & DAIRY
PAIN ET PRODUITS LAITIERS
BROT UND MILCHPRODUKTE



CARNE GUISADA
COOKED MEAT
VIANDE CUISINÉE
GEKOCHTES FLEISCH



FRUTA Y VEGETALES
FRUIT & VEGETABLES
FRUIT ET LÉGUMES
OBST & GEMÜSE



PRESENTACIÓN
PRESENTATION
PRÉSENTATION
PRÄSENTATION

ESPAÑOL

Presentamos una nueva gama de tablas de corte con más de 20 modelos distintos y más de 100 referencias, concebidas para satisfacer todas las necesidades del mercado. Ofrecemos también la posibilidad de fabricar medidas y grosores especiales sobre pedido. La nueva gama de tablas de corte se presenta en dos modalidades; unas fabricadas en Polietileno (PE) por inyección y la gama más extensa en Polietileno 500 alta densidad (HD PE 500) por termocompresión.

ENGLISH

We introduce here with the new range of cutting board with more than 20 different patterns and more than 100 references conceived to fulfill all the market needs. We also offer the possibility to produce special sizes and thicknesses upon request. This new range of cutting boards is presented in two different materials, one made of Polyethylene (PE) using the injection technique and the widest range on High Density Polyethylene 500 (HD PE 500) through thermo compression.

FRANÇAIS

Nous présentons une nouvelle gamme de planches à découper avec plus de 20 modèles différents et plus de 100 références, conçues pour satisfaire tous les besoins du marché. Nous offrons aussi la possibilité de fabriquer des planques avec des mesures et des épaisseurs spéciales sur commande. Cette nouvelle gamme de planches à découper se présentent en deux matériaux différents: certaines sont produites en Polyéthylène (PE) par injection et la majorité de la gamme est produite en Polyéthylène 500 de haute densité (HD PE 500) par thermo compression.

DEUTSCH

Wir präsentieren eine neue Produktreihe von Schneidbrettern mit mehr als 20 verschiedenen Modellen und über 100 Artikel, um die Bedürfnisse des Markts zufrieden zu stellen. Wir bieten auch die Möglichkeit spezielle Maße und Dicke herzustellen abhängig von der Bestellung. Die neue Produktreihe bieten wir in zwei verschiedenen Varianten an: Eine Variante hergestellt aus Polyethylen (PE) durch Spritzverfahren und die breiteste Produktvariante hergestellt aus Polyethylen 500 hohe Dichte (HD PE 500) durch Wärmedruckverfahren.



CARACTERÍSTICAS PRINCIPALES

Las tablas de corte fabricadas en Polietileno 500 alta densidad, se caracterizan por un alto peso molecular (HMWPE) ofreciendo:

- Alta DURABILIDAD
- 25% más resistencia a la ABRASIÓN.
- Mayor temperatura de fusión: 135,4 °C.
- Temperatura de reblandecimiento 83 °C
- Mayor RIGIDEZ

* No presentan deformación durante el aclarado del ciclo de lavado en lavavajillas industriales (temp. máx. aprox. 80 °C).

Conforme a las normativas siguientes:
RD 1712/91 registro sanitario de alimentos
CE 1935/2004.

MAIN FEATURES

The cutting boards made of High Density Polyethylene 500 have higher molecular weight (HMWPE), offering the following properties:

- High DURABILITY
- 25% more resistance to ABRASION
- Higher Fusion temperature: 135,4 °C
- Softening temperature: 83 °C
- Extraordinary RIGIDNESS

* Do not present deformation during the rinsing process of industrial dishwasher cleaning cycle (max. temp. aprox. 80 °C).

Following the CE 1935/2004 regulation.

CARACTÉRISTIQUES PRINCIPALES

Les planches à découper fabriquées en Polyéthylène 500 haute densité ont un poids moléculaire (HMWPE) plus grand qui offre les suivantes propriétés:

- Longue DURÉE
- 25% plus résistant à l'ABRASION
- Température de fusion: 135,4 °C
- Température de ramolissement: 83 °C
- RIGIDITÉ maximale

* Ne présente pas de déformation lors du cycle lavage dans le lave-vaisselles industriel (Temp. max. aprox. 80 °C).

Conforme à la réglementation 1935/2004.

HAUPTEIGENSCHAFTEN

Die Schneidbretter hergestellt aus Polyethylen 500 hohe Dichte haben ein höheres Molekulargewicht (HMWPE), mit folgenden Eigenschaften:

- Hohe LANGLEBIGKEIT
- 25% höherer Verschleisswiderstand
- Höhere Schmelztemperatur: 135,4 °C
- Erweichungstemperatur: 83 °C
- Extrahohe Starrheit

* Es treten keine Verformungen beim Spülvorgang in industriellen Spülmaschinen auf (max. Temp. ca. 80 °C).

Entsprechend der Norm CE 1935/2004.

P9118

300 x 200 x 20



Con pies silicona
With silicon feet
Avec pieds en silicone
Mit Silikonfüßen

REF	Color	mm	H mm	
P911.801		300 x 200	20	1
P911.802		300 x 200	20	1
P911.803		300 x 200	20	1
P911.804		300 x 200	20	1
P911.805		300 x 200	20	1
P911.806		300 x 200	20	1
P911.808		300 x 200	20	1

P9112



Con pies silicona
With silicon feet
Avec pieds en silicone
Mit Silikonfüßen

REF	Color	mm	H mm	
P911.201		400 x 300	20	1
P911.202		600 x 400	20	1

P9120

400 x 200 x 20



Con pies silicona
With silicon feet
Avec pieds en silicone
Mit Silikonfüßen

REF	Color	mm	H mm	
P912.001		400 x 200	20	1

P9113 GN 1/1



Con ranura
With groove
Avec rigole
Mit Fuge

Con pies silicona
With silicon feet
Avec pieds en silicone
Mit Silikonfüßen

REF	Color	mm	H mm	
P911.301		530 x 325	20	1
P911.302		530 x 325	20	1
P911.303		530 x 325	20	1
P911.304		530 x 325	20	1
P911.305		530 x 325	20	1
P911.306		530 x 325	20	1

P9117 GN 1/2

320 x 265 x 20



Con pies silicona
With silicon feet
Avec pieds en silicone
Mit Silikonfüßen

REF	Color	mm	H mm	
P911.701		320 x 265	20	1

P9114

400 x 300 x 20



Con pies silicona
With silicon feet
Avec pieds en silicone
Mit Silikonfüßen

REF	Color	mm	H mm	
P911.401		400 x 300	20	1
P911.402		400 x 300	20	1
P911.403		400 x 300	20	1
P911.404		400 x 300	20	1
P911.405		400 x 300	20	1
P911.406		400 x 300	20	1
P911.408		400 x 300	20	1

VER PRODUCTOS EN / SEE PRODUCTS ON / VOIR PRODUITS EN PAGE / SIEHE PRODUKTE IN

SOPORTE PARA TAPAS GN / STAND FOR GN LIDS /
SUPPORT POUR COUVERCLES GN / STÄNDER FÜR GN DECKEL

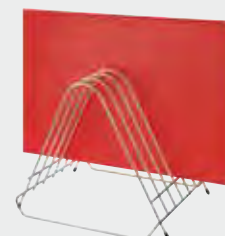

P. 163

P9119

500 x 300 x 20



Con pies silicona
With silicon feet
Avec pieds en silicone
Mit Silikonfüssen

REF	Color	mm	H mm	
P911.901		500 x 300	20	1
P911.902		500 x 300	20	1
P911.903		500 x 300	20	1
P911.904		500 x 300	20	1
P911.905		500 x 300	20	1
P911.906		500 x 300	20	1
P911.908		500 x 300	20	1

P9116

600 x 400 x 20



Con pies silicona
With silicon feet
Avec pieds en silicone
Mit Silikonfüssen

REF	Color	mm	H mm	
P911.601		600 x 400	20	1
P911.602		600 x 400	20	1
P911.603		600 x 400	20	1
P911.604		600 x 400	20	1
P911.605		600 x 400	20	1
P911.606		600 x 400	20	1
P911.608		600 x 400	20	1

P9130 Mesa de corte / Cutting board table / Table de découpe / Schneidstisch



Con ranura
With groove
Avec rigole
Mit Fuge

No incluye contenedor Gastronorm
Delivered without the GN container
Livré sans le bac GN
Ausschliesslich GN Behälter

REF	Color	mm	H mm	
P913.000		650 x 400	110	1

Para almacenar alimentos recién cortados en cubeta GN 1/3
Perfect for storing direct cut products into a 1/3 GN pan
Permet découper les produits directement au dessus du bac Gastronorme 1/3
Für die Aufbewahrung von frischgeschnittenen Lebensmitteln im Behälter GN 1/3

P9115 GN 1/1

530 x 325 x 20



Con pies silicona
With silicon feet
Avec pieds en silicone
Mit Silikonfüssen

REF	Color	mm	H mm	
P911.501		530 x 325	20	1
P911.502		530 x 325	20	1
P911.503		530 x 325	20	1
P911.504		530 x 325	20	1
P911.505		530 x 325	20	1
P911.506		530 x 325	20	1
P911.508		530 x 325	20	1

P9135 Bar



Sin pies
Without feet
Sans pieds
Ohne Füsse

REF	Color	mm	H mm	
P913.501		160 x 250	10	1
P913.601		250 x 200	10	1
P913.701		300 x 200	10	1
P913.901		320 x 240	10	1

P911407 **Tabla de corte / Cutting Board / Planche à découper / Schneidbretter**



Con pies silicona
With silicon feet
Avec pieds en silicone
Mit Silikonfüssen

**VIOLET
COLLECTION**
P. 104

REF	mm	H mm	
P911.407	400 x 300	20	1
P911.507	530 x 325 (1/1)	20	1
P911.607	600 x 400	20	1

P901 **Recogeverduras inox / St/Steel vegetable picker / Pelle à légumes inox / Gemüsehacker rostfrei**



REF	cm	
P901.014	14 x 10	1
P901.018	18 x 12	1



4.5 UTENSILIOS DE COCINA / KITCHEN UTENSILS / USTENSILES DE CUISINE / KÜCHENUTENSILIEN

P600 Balanza mecánica / Mechanical scale / Balance mécanique / Mechanische Waage



REF	kg	Grs	Plataforma / Surface / Plateau / Plattform cm	
P600.005	5	20	20 x 20	1

Cuerpo y bandeja de acero inox.
Bandeja superior plana con botón regulador.
Body and upper flat platform in St/Steel with regulation button.
Corps et plate-forme plane supérieure en inox.
Bouton de régulation.
Körper und Plattform aus rostfreiem Stahl.
Ebene obere Plattform mit regulierbarem Knopf.

ELEMENTOS DE MEDIDA / MEASURING UTENSILS / USTENSILES DE MESURE / MESSUTENSILIEN

P602 Balanza mecánica / Mechanical scale / Balance mécanique / Mechanische Waage



REF	kg	Grs	Plataforma / Surface / Plateau / Plattform Ø cm	
P602.015	15	50	26	1

Cuerpo y bandeja de acero inox.
Bandeja superior bombeada con botón regulador.
Body and upper conical platform in St/Steel with regulation button.
Corps et plate-forme bombée supérieure en inox. Bouton de régulation.
Körper und Plattform aus rostfreiem Stahl.
Halbkugelige obere Plattform mit regulierbarem Knopf.

P609 Balanza digital / Electronic scale / Balance électronique / Digitale Waage

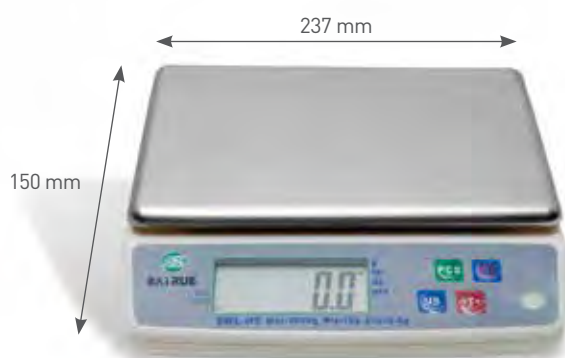

REF	kg	Grs	
P609.010	10	2	1

Cable de alimentación no incluido. Funciona con pilas /
Power cable not included. Battery powered /
Câble d'alimentation non inclus. Fonctionne avec des piles /
Stromkabel nicht enthalten. Batteriebetrieben.

P6092 Balanza digital / Digital kitchen scale / Balance électronique / Digitale Waage



REF	kg	d (g)	
P609.200	15	1	1

Plataforma en acero inoxidable. Pantalla LED. Funciona con pilas /
Surface made of St/Steel. LED Display. Battery powered /
Plateau fabriquée en acier inoxydable. Scran LED. Fonctionne avec des piles /
Plattform rostfrei. LED Display. Batteriebetrieben.

P6097 Balanza electrónica / Electronic kitchen scale / Balance électronique / Elektronische Waage



REF	kg	Grs	Plataforma / Surface / Plateau / Plattform Ø cm	
P609.705	5	1	11	1

Gran precisión / Multifunción de peso / Contador de piezas / Sistema ahorro energía / Bandeja de plástico.
High accuracy / Multi-function weight and counting / Energy-saving system / Plastic Platform.
Haut précision / Multi-fonction des poids / Compteur des pièces / Système d'économie d'énergie / Plateau en plastique.
Hohe Präzision / Multi-Funktion Wiegen / Stückzähler
Energiesparsystem / Plattform Plastik.

UTENSILIOS /
UTENSILS /
USTENSILES

P611 Reloj de cocina digital / Kitchen timer alarm /
Minuteur de cuisine / Digitale Küchenuhr



REF	cm	
P611.000	6,8 x 6,8 x 2,5	1

P9802 Termómetro de cocción / Cooking thermometer /
Thermomètre à cuisson / Kochthermometer



Con protección de plástico / With plastic protection.
Avec gaine plastique / Mit Plastikschutz.

REF	L cm	Temp. max.	
P980.200	28	100 °C	1

P9800 Termómetro nevera /
Cold storage thermometer /
Thermomètre congélateur /
Kühlschrankthermometer



Acabado esmaltado /
Enameled finish /
Émaillé /
Emaillierte Ausfertigung

REF	L cm	Temp.	
P980.000	28	-30 °C / +50 °C	1

P98005 Termómetro nevera horizontal /
Horizontal refrigerator thermometer /
Thermomètre congélateur horizontal /
Horizontales Kühlschrankthermometer



REF	mm	Temp.	
P980.050	135 x 35	-40 °C / +20 °C	24

P9816

Termómetro de cocción / Cooking thermometer /
Thermomètre à cuisson / Kochthermometer



Con protección de plástico /
With plastic protection.
Avec gaine plastique /
Mit Plastikschutz.

REF	L cm	Temp.	
P981.600	17	-10 °C / +200 °C	1

P981650

Termómetro bolsillo con protección /
Pocket thermometer with protection /
Thermomètre de poche avec protection /
Taschenthermometer mit Schutz



REF	L cm	Temp.	
P981.650	14,3	-40 °C / +70 °C	24

P9814

Termómetro digital / Digital thermometer /
Thermomètre digital / Digitales Thermometer



Con sonda de acero inoxidable.
Protección antisalpicaduras. Con pantalla iluminada.
La sonda esta sujeta al lateral del aparato.
With St/Steel probe. Splash-proof. Illuminated display.
Probe attached to side panel.
Avec sonde inox. Etanche aux éclaboussements.
Ecran illuminé. La sonde est attachée au côté lateral de l'appareil.
Temperaturfühler aus rostfreiem Stahl
Antispritzschutz. Beleuchtetes Display. Seitlicher Fühlerhalter.

REF	mm	Display mm	Temp.	
P981.400	135 x 92 x 27	42 x 22	-20 °C / +200 °C	1

P9815

Termómetro digital de cocción con temporizador /
Cooking thermometer with timer /
Thermomètre à cuisson avec temporiseur /
Digitales Kochthermometer mit Timer-Funktion



Plástico blanco. Base magnética para sujeción en superficies de metal.
Temperatura/tiempo programable con señal de alarma.
Sonda de acero inoxidable y cable alambre.
White plastic. Magnetic base for attachment on metal surface. Programmable temperature/time, with alarm signal. St/Steel probe and wire cable.
Plastique blanc. Base magnétique pour l'attacher à une surface métallique.
Température/temps programmable avec sonnette d'alarme. Sonde inox et filet.
Weisses Plastik. Magnetische Haftung für metallische Oberflächen. Temperatur/Zeit programmierbar mit Alarm. Rostfreier Fühler mit Drahtkabel.

REF	L mm sonda + cable	Temp.	
P981.500	90	0 °C / +200 °C	1

P9804 Termómetro infrarrojos con mira laser / Infrared thermometer with laser pointer /
Thermomètre infra-rouge a visée laser / Infrarot Thermometer mit Laser Pointer



REF	L cm	Temp.	
P980.400	17	-60 °C / +500 °C	1

IDEA!

Pantalla LCD
LCD Display
Écran LCD
LCD Display

Ideal para medir la temperatura de la superficie de los alimentos, sin contacto.
Non-contact temperature measure food's surface.
Ideal pour la mesure de température de surface des aliments, sans contact.
Ideal für Temperaturmessung von Lebensmittel ohne Berührung.

P604 Jarra de medidas / Measuring jug /
Pot mesureur / Messbecher



REF	Lts	
P604.001	1,00	1
P604.002	2,00	1

P846 Jarra de medidas en polipropileno /
Polypropylene measuring jug /
Pot mesureur en polypropylène /
Messbecher aus Polypropylen



REF	Lts	
P846.025	0,25	1
P846.050	0,50	1
P846.100	1,00	1
P846.200	2,00	1
P846.300	3,00	1

P6045 Juego 4 cazos de medidas inox /
St/Steel 4 pcs set measuring cups /
Set 4 casseroles doseur /
4 teiliges Messkellenset rostfreies Stahl



REF	ml	
P604.500	59 - 78 - 118 - 236	12

P603 Cubo con base /
Bucket with base /
Seau avec base /
Eimer mit Skalierung

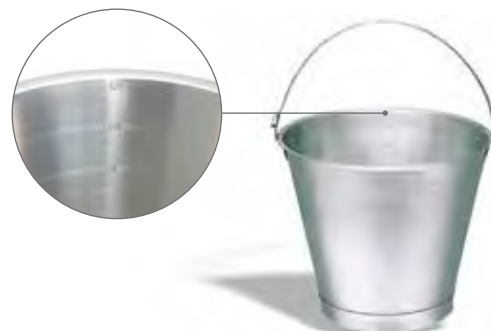

REF	Ø cm	H cm	Lts	
P603.012	31,0	28,50	12,00	1
P603.015	32,5	32,50	15,00	1

P9473 Guantes protección térmica / Heat protection gloves / Gants protection thermique / Hitzehandschuh



REF	Talla / Size / Taille / Grösse	
P947.301	S	1
P947.302	M	1
P947.303	L	1

Se venden por pares
Sold in pairs
Vendues par paires
Verkauf im Paar

Fabricados con recubrimiento de nitrilo en el exterior y con forro interior de algodón y kevlar jersey. Llevan un tratamiento Actifresh y Sanitized que los provee de protección contra los micro-organismos los cuales pueden causar malos olores y riesgo de infecciones.

Outer nitril coated. Inner made of cotton and kevlar jersey. They enjoy of Actifresh and Sanitized treatment to fight against micro organisms which can cause bad scents and risk of infections.

Fabriqués avec un revêtement de nitrile à l'extérieur. Interieur de coton et kevlar jersey avec un traitement Actifresh et Sanitized qui les fournit de protection contre les microorganismes lesquels peuvent causer de mauvais odeurs et risque d'infections.

Exteriore Herstellung aus Nitril. Innen aus Baumwolle und Kevlar Jersey. Sie werden mit Aktiv-Frisch- und Satnierungverfahren behandelt, um gegen die Mikroorganismen entgegenzuwirken, die ursächlich sind für schlechte Gerüche und ein Risiko für Infektionen sein können.

P9477 Manopla silicona con funda algodón / Silicone oven glove with cotton cover /
Gant silicone à fourreau coton / Silikonhandschuh mit Baumwollfutter



REF	L cm	
P947.700	42,5	1

P9474 Manopla Silicona / Silicone oven mitt /
Moufle en silicone / Silikonbackhandschuh



REF	L cm	
P947.400	30	1

P9476 Paño de silicona / Silicone pot-grabber /
Torchon en silicone / Silikontuch

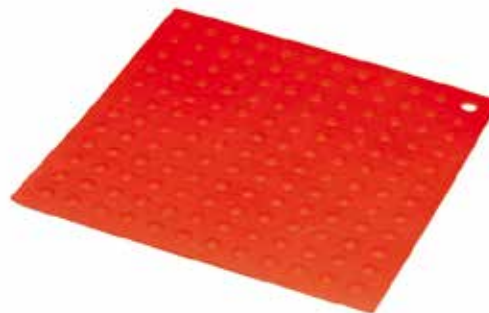

REF	cm	
P947.600	17,6 x 17,6	1

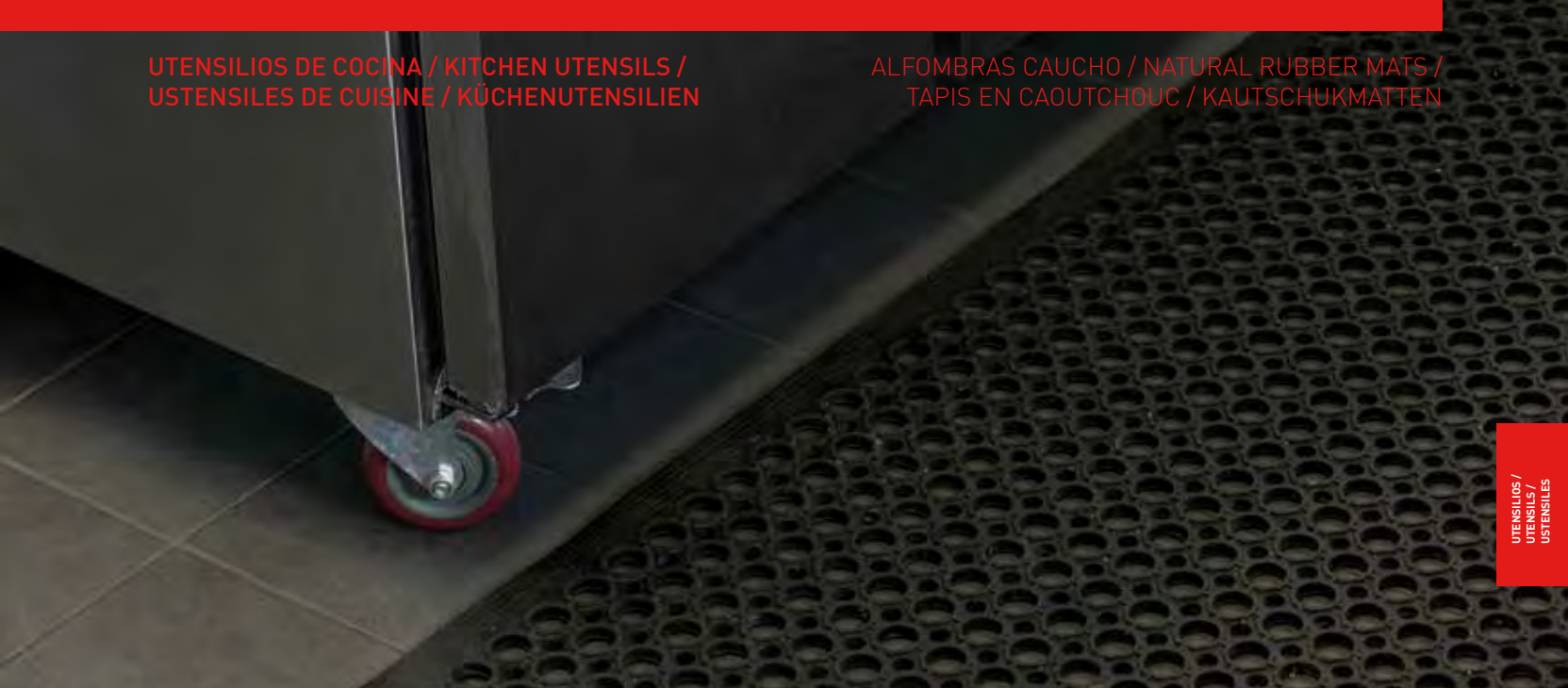

P26000 Alfombra / Mat / Tapis / Matte

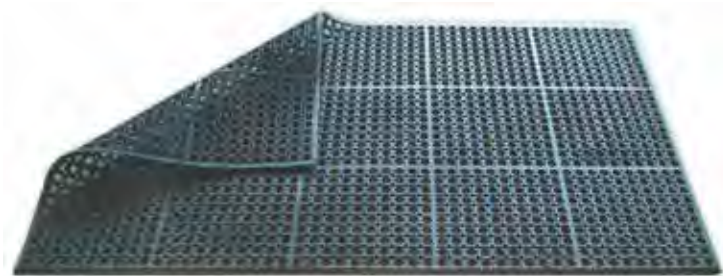

REF	cm	
P26.000	90 x 150 x 1,20	1

 REACH
COMPLIANT

P26001 Alfombra / Mat / Tapis / Matte

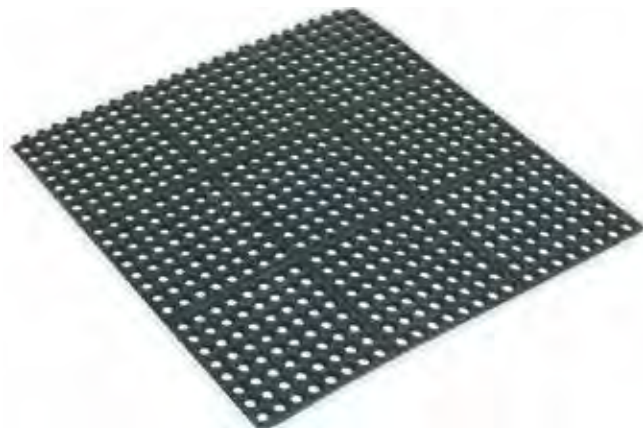

REF	cm	
P26.001	90 x 90 x 1,20	1

 REACH
COMPLIANT

Estas alfombras se pueden conectar unas con otras formando mayores superficies.
You can connect these mats forming bigger surfaces.
Avec système de liaison pour composer une surface plus grande.
Für grössere Flächen kann man diese Matten mit anderen verbinden.





**CUBETAS GASTRONORM /
GASTRONORM CONTAINERS /
BACS GASTRONORME /
GASTRONORM BEHÄLTER**

5.1	INOX 18/10 / 18/10 ST/STEEL / INOX 18/10 / EDELSTAHL 18/10	156
5.2	CUBETAS GN SP3 / SP3 GN PANS / BACS GN SP3 / GASTRONORM BEHÄLTER SP3 /	159
5.3	COMPLEMENTOS GASTRONORM / GASTRONORM ACCESSORIES / ACCESSOIRES GASTRONORME / GASTRONORM ASSESSOIRES	163
5.4	CON FONDO DIFUSOR / WITH SANDWICH BOTTOM / AVEC FOND THERMO-DIFFUSEUR / MIT SANDWICHBODEN	165
5.5	POLICARBONATO / POLYCARBONATE / POLYCARBONATE / POLYCARBONAT	166
5.6	SIN BISFENOL-A / BISPHENOL-A FREE / SANS BISPHÉNOL-A / OHNE BISFENOL-A	168
5.7	POLIPROPILENO / POLYPROPYLENE / POLYPROPYLÈNE / POLYPROPYLEN	170
5.8	VIOLET COLLECTION	172

5.1 CUBETAS GASTRONORM / GASTRONORM CONTAINERS / BACS GASTRONORME / GASTRONORM BEHÄLTER

CUBETAS GASTRONORM / GASTRONORM CONTAINERS / BACS GASTRONORME / GASTRONORM BEHÄLTER

CUBETAS GASTRONORM / GASTRONORM CONTAINERS / BACS GASTRONORME / GASTRONORM BEHÄLTER

ESPAÑOL

Conforme a la norma en-631.2 Pujadas ofrece una de las gamas de cubetas gastronorm de fabricación propia más amplia del mercado

ENGLISH

According to en-631.2 Pujadas offers one of the most specialized ranges, in-house manufacturing, of gastronorm containers in the market

FRANÇAIS

Suivant la norme en-631.2 Pujadas propose une des gammes de bacs gastronorme de propre fabrication des plus spécialisés du marché

DEUTSCH

Entsprechend der norm EN-631.2 bietet Pujadas aus eigener Herstellung eine der breitesten Produktpalette Im handel an.

ACERO INOXIDABLE / ST/STEEL / ACIER INOXYDABLE / ROSTFREIER STAHL 18/10



BORDES REFORZADOS / REINFORCED EDGES / BORDS RENFORCÉS / VERSTÄRKTÉ RÄNDER

GEOMETRÍA ADAPTADA: + LIMPIEZA + CAPACIDAD / RADIOUS SPECIALLY DESIGNED FOR: + CAPACITY + CLEANING / GÉOMÉTRIE ADAPTÉE: + PROPRETÉ + CAPACITÉ / RADIUS SPEZIELL DESIGN: + KAPAZITÄT + REINIGUNG

SUPER PAN 3 ACERO INOXIDABLE / ST/STEEL / ACIER INOXYDABLE / ROSTFREIER STAHL 18/10

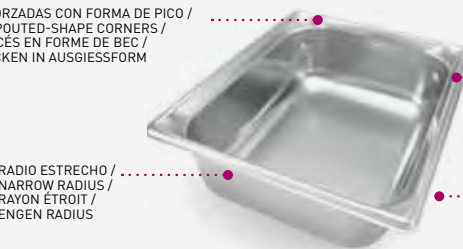

ESQUINAS REFORZADAS CON FORMA DE PICO / REINFORCED SPOUTED-SHAPE CORNERS / COINS RENFORCÉS EN FORME DE BEC / VERSTÄRKTÉ ECKEN IN AUSGIESSFORM

RADIO ESTRECHO / NARROW RADIUS / RAYON ÉTROIT / ENGEN RADIUS

APILADO ANTIATASCOS / ANTI-JAM STACKING LUGS / POINTES D'EMPILAGE ANTI-COINCENCEMENT / VERKEILUNG SICHERE STAPELNASEN

BORDES APLANADOS DE LA FUENTE / FLATTENED PAN EDGES / BORDS DE BACS GN APLATIS / ABGEFLACHTÉ WANNENKANTEN VERHINDERN

POLICARBONATO / POLICARBONATO / POLYCARBONATE / POLYCARBONAT

- 40 °C
+ 130 °C

BORDES REFORZADOS / REINFORCED RIMS / BORDS RENFORCÉS / VERSTÄRKTÉ RÄNDER

MARCAJE MODELO CUBETA / CONTAINER MODEL / TYPE DE BAC / MODELMARKIERUNG AM BEHÄLTER

TEXTURA PARA EVITAR RALLADAS / TEXTURING CORNERS TO AVOID SCRATCHING / CÔTÉS GRANITÉS POUR ÉVITER RAYURES / STRUKTUR UM VERKRATZUNGEN ZU VERHINDERN



MAYOR GROSOR / THICKER / PLUS ÉPAIS / DICKER

GRADUACIÓN EXTERNA DE CAPACIDAD / GRADUATIONS MARKED EXTERNALLY / ÉCHELLE DE GRADUATIONS À L'EXTÉRIEUR / EXTERNE SKALIERUNG DES FASSUNGSVERMÖGEN

CARACTERÍSTICAS MARCADAS EN EL FONDO / MAIN FEATURES MARKED ON THE BASE / CARACTERISTIQUES MARQUÉS AU FOND / EIGENSCHAFTEN IM BODEN MARKIERT

SIN BISFENOL-A / BISPHENOL-A FREE / SANS BISPHÉNOL-A / OHNE BISFENOL-A

- 40 °C
+ 90 °C



POLIPROPILENO / POLYPROPYLENE / POLYPROPYLENE / POLYPROPYLEN

- 40 °C
+ 110 °C

HERMÉTICO CON TAPA POLINORM / HERMETIC WITH POLINORM LID / HERMETIQUE AVEC COUVERCLE POLINORM / HERMETISCH MIT POLINORM DECKEL

BORDES REFORZADOS / REINFORCED RIMS / BORDS RENFORCÉS / VERSTÄRKTÉ RÄNDER

MARCAJE MODELO CUBETA / CONTAINER MODEL / TYPE DE BAC / MODELMARKIERUNG AM BEHÄLTER

TEXTURA PARA EVITAR RALLADAS / TEXTURING CORNERS TO AVOID SCRATCHING / CÔTÉS GRANITÉS POUR ÉVITER RAYURES / STRUKTUR UM KRATZER ZU VERHINDERN



MAYOR GROSOR / THICKER / PLUS ÉPAIS / DICKER

GRADUACIÓN EXTERNA DE CAPACIDAD / GRADUATIONS MARKED EXTERNALLY / ÉCHELLE DE GRADUATIONS À L'EXTÉRIEUR / EXTERNE SKALIERUNG DES FASSUNGSVERMÖGEN

CARACTERÍSTICAS MARCADAS EN EL FONDO / MAIN FEATURES MARKED ON THE BASE / CARACTERISTIQUES MARQUÉS AU FOND / EIGENSCHAFTEN IM BODEN MARKIERT

COCCIÓN /
COOKING /
CUISSON /
KOCHEIN

PATENTED EXCLUSIVE



GN CON FONDO DIFUSOR /
GN PAN WITH SANDWICH BASE /
BAC GN AVEC FOND THERMO-DIFFUSEUR /
GN BACKFORM MIT SANDWICHBODEN



GN ALUMINIO ANTIADHERENTE /
NON-STICK ALUMINIUM GN PAN /
BAC GN ANTI-ADHÉSIF EN ALUMINIUM /
GN BACKFORM ALUMINIUM ANTIHAFT



BANDEJAS GN ESPECIAL HORNO /
SPECIAL OVEN GN PANS /
PLAQUES SPECIALES GN POUR FOUR /
SPEZIELLE GN OFENFORMEN

TRANSPORTE /
TRANSPORT /
TRANSPORT /
TRANSPORT



GN INOX + TAPA INOX HERMÉTICA /
ST/STEEL GN + ST/STEEL HERMETIC LID /
BAC GN INOX + COUVERCLE ÉTANCHE INOX /
GN EDELSTAHL + EDELSTAHLDECKEL HERMETISCH

TEMP. 120°C

HERMÉTICO / HERMETIC
ÉTANCHE / HERMETISCH



POLICARBONATO O CUBETA SIN BISFENOL-A + TAPA POLINORM® /
POLYCARBONATE OR BPA FREE + POLINORM® LID /
POLYCARBONATE OUI SANS BPA + COUVERCLE POLINORM® /
POLYCARBONAT ODER OHNE BISFENOL-A BEHÄLTER + POLINORM®DECKEL

TEMP. 100°C



GN POLIPROPILENO + TAPA POLINORM® /
POLYPROPYLENE + POLINORM® LID /
GN POLYPROPYLENE + COUVERCLE POLINORM® /
GN POLIPROPILEN + POLINORM® DECKEL

TEMP. 90°C

ALMACENAMIENTO /
STORAGE /
STOCKAGE /
LAGERUNG



GN POLICARBONATO + TAPA POLICARBONATO /
POLYCARBONATE GN + POLYCARBONATE LID /
GN POLYCARBONATE + COUVERCLE POLYCARBONATE /
GN POLYCARBONAT + POLYCARBONAT DECKEL



GN POLICARBONATO + TAPA POLINORM® /
POLYCARBONATE GN + POLINORM® LID /
POLYCARBONATE + COUVERCLE POLINORM® /
GN POLYCARBONAT + POLINORM® DECKEL



GN POLIPROPILENO + TAPA POLINORM® /
POLYPROPYLENE + POLINORM® LID /
GN POLYPROPYLENE + COUVERCLE POLINORM® /
GN POLYPROPYLEN + POLINORM® DECKEL

V I O L E T

C O L L E C T I O N



ANTIALÉRGICO /
ALLERGEN-FREE /
ANTI ALLERGIQUE /
ANTI ALLERGIE

PRESENTACIÓN /
DISPLAY /
PRÉSENTATION /
PRÄSENTATION



GN POLICARBONATO + TAPA POLICARBONATO /
POLYCARBONATE GN + POLYCARBONATE LID /
GN POLYCARBONATE + COUVERCLE POLYCARBONATE /
POLYCARBONAT GN + POLYCARBONAT DECKEL



GN INOX CON FONDO DIFUSOR + TAPA POLICARBONATO /
ST/STEEL GN WITH SANDWICH BASE + POLYCARBONATE LID /
GN INOX AVEC FOND THERMO-DIFFUSEUR + POLYCARBONATE /
EDELSTAHL GN MIT SANDWICHBODEN + POLYCARBONAT DECKEL



GN MELAMINA /
MELAMINE GN /
GN MÉLAMINE /
MELAMIN GN

VER PÁGINA / REFER TO PAGE /
VOIR PAGE / SIEHE SEITE
P. 394

5.1 SELECCIÓN CUBETAS GASTRONORM / GASTRONORM CONTAINERS SELECTION / SELECTION BACS GASTRONORME / AUSWAHLÜBERSICHT GASTRONORM BEHÄLTER

INOX 18/10 /
18/10 ST/STEEL /
INOX 18/10 /
EDELSTAHL 18/10

SP3

INOX 18/10 /
18/10 ST/STEEL /
INOX 18/10 /
EDELSTAHL 18/10

INOX 18/10 FONDO DIFUSOR /
18/10 ST/STEEL SANDWICH BOTTOM /
INOX 18/10 FOND THERMO-DIFFUSEUR /
EDELSTAHL 18/10 SANDWICHBODEN

ALUMINIO ANTIADHERENTE /
NON-STICK ALUMINIUM /
ALUMINIUM ANTI-ADHÉSIF /
ALUMINIUM ANTIHAFT



NSF



NSF



NSF



VER PÁGINA / REFER TO PAGE /
VOIR PAGE / SIEHE SEITE
P. 406



VER PÁGINA / REFER TO PAGE /
VOIR PAGE / SIEHE SEITE
P. 70

PRESENTACIÓN /
APPEARANCE /
PRÉSENTATION /
PRÄSENTATION



RESISTENCIA /
ROBUSNESS /
ROBUSTESSE /
RESISTENZ



ALMACENAMIENTO /
STORAGE /
STOCKAGE /
LAGERUNG



BAÑO-MARIA /
BAIN MARIE /
BAIN-MARIE /
WASSERBAD



TEMPERATURA MAX /
TEMPERATURE MAX /
TEMPÉRATURE MAX. /
MAX. TEMPERATUR



HORNO /
OVEN /
FOUR /
OFEN



MICROONDAS /
MICRO-WAVE /
MICRO-ONDES /
MIKROWELLE



COCCIÓN /
COOKING /
CUISSON /
KOCHEN



INDUCCIÓN /
INDUCTION /
INDUCTION /
INDUKTION



TRANSPORTE EN CALIENTE /
WARM TRANSPORTATION /
TRANSPORT CHAUD /
WARMER TRANSPORT



TAPA POLINORM /
POLINORM LID /
COUVERCLE POLINORM /
POLINORM DECKEL



ANTIATASCOS /
ANTI-JAM /
ANTI-COINCEMENT /
STAPELNASEN /



RECOMENDADO / RECOMMENDED /
RECOMMANDÉ / EMPFOHLEN

ACCEPTABLE / SUITABLE /
ACCEPTABLE / ANNEHMBAR

NO RECOMENDADO / NOT RECOMMENDED /
PAS RECOMMANDÉ / NICHT EMPFOHLEN

SELECCIÓN CUBETAS GASTRONORM / GASTRONORM CONTAINERS SELECTION /
SELECTION BACS GASTRONORME / AUSWAHLÜBERSICHT GASTRONORM BEHÄLTER

POLICARBONATO /
POLYCARBONATE /
POLYCARBONATE /
POLYCARBONAT

SIN BISFENOL-A /
BISPHENOL-A FREE /
SANS BISPHÉNOL-A /
OHNE BISFENOL-A

POLIPROPILENO /
POLYPROPYLENE /
POLYPROPYLENE /
POLYPROPYLEN

VIOLET
COLLECTION

MELAMINA* /
MELAMINE* /
MÉLAMINE* /
MELAMIN*



VER PÁGINA / REFER TO PAGE /
VOIR PAGE / SIEHE SEITE
P. 374

●	●	●	✓
✓	✓	●	✓
✓	✓	●	●
●	●	✗	●
130 °C	90 °C	110 °C	70 °C
130 °C	✗	✗	✗
✓	✓	✓	✗
✗	✗	✗	✗
✗	✗	✗	✗
130 °C	80 °C	✗	70 °C
✓	✓	✓	✗
✗	✗	✗	✗

* AMBIENTE HÚMEDO / HUMID ENVIRONMENT / ENVIRONNEMENT HUMIDE / FEUCHTE UMGEBUNG

5.1 CUBETAS GASTRONORM / GASTRONORM CONTAINERS / BACS GASTRONORME / GASTRONORM BEHÄLTER

MEDIDAS Y COMBINACIONES / SIZES AND COMBINATIONS / MESURES ET COMBINAISONS / MASSE UND KOMBINATIONEN

COMBINACIONES / COMBINATIONS / COMBINAISONS / KOMBINATIONEN



MEDIDAS DE ENCASTE / FITTING MEASURES / MESURES D'EMBOÛTEMENT / MASSE DER EINSETZLÖCHER

Modelo	"A"	"B"
2/1	630	510
1/1	510	305
2/3	333	305
1/2	305	245
1/3	305	155
1/4	245	142
1/6	156	142
1/9	156	88

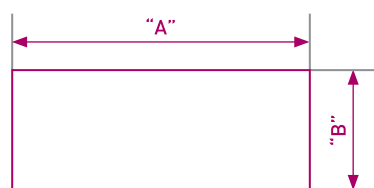

CUBETAS GASTRONORM / GASTRONORM CONTAINERS /
BACS GASTRONORME / GASTRONORM BEHÄLTER

TAPA GN POLINORM® / GN POLYNORM® LID / GN COUVERCLE POLYNORM® / GN POLYNORM® DECKEL

PATENTED EXCLUSIVE



CUBETAS GN /
GN CONTAINERS /
BACS GN

DISPONIBLE EN SEIS COLORES / AVAILABLE IN SIX COLOURS /
DISPONIBLE EN SIX COULEURS / VERFÜGBAR IN SECHS FARBEN



ADAPTABLES A / ADJUSTABLES TO / ADAPTABLE À / PASSEND ZU



TAPA POLINORM /
POLINORM LID /
COUVERCLE POLINORM /
POLINORM DECKEL

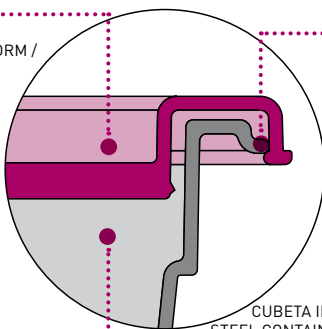

CLIPS PARA CIERRE
CUBETA INOX Y PC /
FLAPS TO FIT WITH
GN INOX AND PC /
RAINURES POUR
CLIPSER BACS GN
INOX ET PC /
VERSCHLUSSKLEMME
FÜR EDELSTAHL UND
PC BEHÄLTER

CUBETA INOX / POLICARBONATO /
STEEL CONTAINER / POLYCARBONATE /
BAC INOX / POLYCARBONATE /
EDELSTAHL / POLYCARBONAT BEHÄLTER

TAPA POLINORM /
POLINORM LID /
COUVERCLE POLINORM /
POLINORM DECKEL

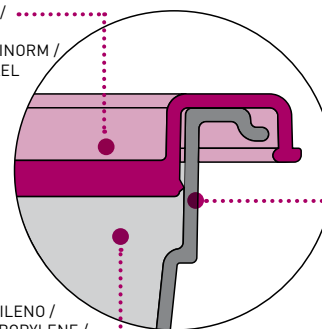

CIERRE HERMÉTICO
PARA CUBETAS DE PP /
HERMETICAL FOR PP
CONTAINERS /
HERMETIQUE SUR
BACS PP /
HERMETISCHER
VERSCHLUSS
FÜR BEHÄLTER AUS PP

CUBETA POLIPROPILENO /
CONTAINER POLYPROPYLENE /
BAC POLYPROPYLENE /
POLYPROPYLEN BEHÄLTER

5.1 CUBETAS GASTRONORM / GASTRONORM CONTAINERS / BACS GASTRONORME / GASTRONORM BEHÄLTER



GASTRONORM INOX 18/10 /
18/10 ST/STEEL GASTRONORM /
GASTRONORME INOX 18/10 /
GASTRONORM EDELSTAHL 18/10

2/1 650 x 530 mm

18/10



REF	H mm	Lts	
P210.201	20	6,20	6
P210.401	40	11,50	6
P210.651	65	18,80	6
P211.001	100	28,90	6
P211.501	150	43,10	3
P212.001	200	52,00	3

1/1 530 x 325 mm

18/10



REF	H mm	Lts	
P110.201	20	2,80	6
P110.401	40	5,10	6
P110.551	55	7,00	6
P110.651	65	8,30	6
P111.001	100	14,20	6
P111.501	150	20,20	6
P112.001	200	26,00	6

2/3 353 x 325 mm

18/10



REF	H mm	Lts	
P230.201	20	1,70	6
P230.401	40	3,10	6
P230.651	65	5,60	6
P231.001	100	8,80	6
P231.501	150	13,20	6
P232.001	200	18,30	6

1/2 325 x 265 mm

18/10

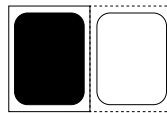

REF	H mm	Lts	
P120.201	20	1,20	6
P120.401	40	2,20	6
P120.651	65	4,10	6
P121.001	100	6,10	6
P121.501	150	9,10	6
P122.001	200	12,00	6

2/4 530 x 162 mm

18/10



REF	H mm	Lts	
P240.401	40	1,80	6
P240.651	65	4,00	6
P241.001	100	6,00	6
P241.501	150	10,00	6

1/3 325 x 176 mm

18/10

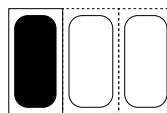

REF	H mm	Lts	
P130.201	20	0,80	6
P130.401*	40	1,50	6
P130.651	65	2,50	6
P131.001	100	3,80	6
P131.501	150	5,60	6
P132.001	200	7,30	6

IDEA!

- * Cubeta GN especial para vitrinas mostrador snack.
- * Special GN container for snack showcases.
- * Bac GN spécial pour vitrines snack.
- * Spezial GN Behälter für Snackglasvitrinen

1/4 265 x 162 mm

18/10

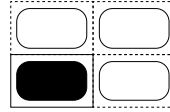

REF	H mm	Lts	
P140.201	20	0,50	6
P140.651	65	1,70	6
P141.001	100	2,80	6
P141.501	150	4,10	6
P142.001	200	5,00	6

1/6 176 x 162 mm

18/10

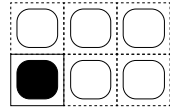

REF	H mm	Lts	
P160.651	65	1,00	6
P161.001	100	1,60	6
P161.501	150	2,20	6
P162.001	200	2,90	6

1/9 176 x 108 mm

18/10

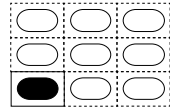

REF	H mm	Lts	
P190.651	65	0,60	6
P191.001	100	0,80	6

**Fondos perforados para cubetas / Perforated bottoms for containers /
Egouttoirs pour bacs / Gelochte Böden für Behälter**



Aptos para cubetas SP3 hasta 100 mm de profundidad
Adjustable to SP3 upto 100 mm depth
Adaptables à bacs SP3 jusqu'à 100 mm profondeur
Geeignet für Behälter SP3 bis 100 mm tief



REF	Mod	
P215.000	2/1	1
P115.000	1/1	1
P235.000	2/3	1
P125.000	1/2	1
P135.000	1/3	1
P145.000	1/4	1

Perfiles divisorios / Adaptable bars / Barrettes de composition / Profilstege



REF	H mm	L cm	
P111.111	1/1	53,0	1
P122.222	1/2	32,5	1

Para realizar cualquier composición con las cubetas gastronorm.
To arrange any composition with gastronorm containers.
Pour réaliser toute composition avec les bacs gastronorme.
Für die Realisierung aller Kombinationen mit den GN Behälter.

Asas móviles / Falling handles / Anses tombantes / Fallgriffe

Añadir AM a la referencia de la cubeta elegida
Add AM to the GN container reference
Ajouter AM à la référence du bac GN
Fügen Sie die AM zu den ausgewählten Art.Nr. der GN
Apta para todas las medidas de cubetas
Suitable for all GN sizes
Apte sur toutes les dimensions GN
Einsetzbar an alle Größen der Behälter



Precio cubeta / Container price / Prix bac / Behälterpreis	1
---	---

Asas fijas / Fixed handles / Anses fixes / Feste Griffe

Añadir AF a la referencia de la cubeta elegida
Add AF to the GN container reference
Ajouter AF à la référence du bac GN
Fügen Sie die AF zu den ausgewählten Art.Nr. der GN
Sólo para cubetas 1/2, 1/3, 1/4 y 1/6
Only for containers 1/2, 1/3, 1/4 and 1/6
Seulement pour bacs 1/2, 1/3, 1/4 et 1/6
Nur für Behälter 1/2, 1/3, 1/4 und 1/6



Precio cubeta / Container price / Prix bac / Behälterpreis	1
---	---

5.1 CUBETAS GASTRONORM / GASTRONORM CONTAINERS / BACS GASTRONORME / GASTRONORM BEHÄLTER



GASTRONORM INOX 18/10 /
18/10 ST/STEEL GASTRONORM /
GASTRONORME INOX 18/10 /
GASTRONORM EDELSTAHL 18/10

2/1 650 x 530 mm

18/10

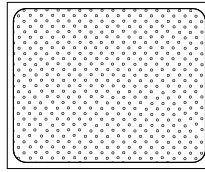

REF	H mm	
P210.202	20*	6
P210.402	40*	6
P210.652	65*	6
P211.002	100**	6
P211.502	150**	3
P212.002	200**	3

1/1 530 x 325 mm

18/10

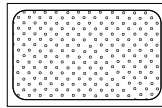

REF	H mm	
P110.202	20*	6
P110.402	40*	6
P110.552	55*	6
P110.652	65*	6
P111.002	100**	6
P111.502	150**	6
P112.002	200**	6

2/3 353 x 325 mm

18/10

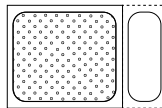

REF	H mm	
P230.202	20*	6
P230.402	40*	6
P230.652	65*	6
P231.002	100**	6
P231.502	150**	6
P232.002	200**	6

1/2 325 x 265 mm

18/10

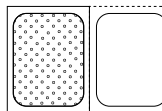

REF	H mm	
P120.652	65*	6
P121.002	100**	6
P121.502	150**	6
P122.002	200**	6

1/3 325 x 176 mm

18/10

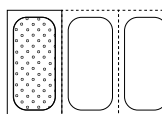

REF	H mm	
P130.202	20*	6
P130.402	40*	6
P130.652	65*	6
P131.002	100**	6
P131.502	150**	6
P132.002	200**	6

* Fondo perforado
* Perforated bottom
* Fond perforé
* Gelochter Boden

** Fondo y laterales perforados
** Perforated bottom and sides
** Fonds et latéraux perforés
** Boden und Seiten gelocht

SP3

SUPER PAN 3



ESQUINAS REFORZADAS CON FORMA DE PICO /
REINFORCED SPOUTED-SHAPE CORNERS /
COINS RENFORCÉS EN FORME DE BEC /
VERSTÄRKT ECKEN IN AUSGIESSFORM



RADIO ESTRECHO /
NARROW RADIUS /
RAYON ÉTROIT /
ENGEN RADIUS

APILADO ANTIATASCOS /
ANTI-JAM STACKING LUGS /
POINTES D'EMPILAGE ANTI-
COINCEMENT /
VERKEILUNG SICHERE
STAPELNASEN

BORDES APLANADOS /
FLATTENED PAN EDGES /
BORDS DE BACS GN APLATIS /
ABGEFLACHTE WANNENKANTEN
VERHINDERN

CUBETAS GN /
GN CONTAINERS /
BACS GN

1/1 530 x 325 mm

18/10



REF	H mm	Lts	
90002	20	-	6
90012	40	5,4	6
90052	55	7,3	6
90022	65	8,5	6
90042	100	13,4	6
90062	150	19,9	6
90082	200	26,1	6

2/3 353 x 325 mm

18/10

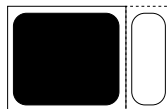

REF	H mm	Lts	
90102	20	-	6
90112	40	3,4	6
90122	65	5,4	6
90142	100	8,0	6
90162	150	11,9	6
90182	200	15,5	6

1/2 325 x 265 mm

18/10



REF	H mm	Lts	
90202	20	-	6
90212	40	2,4	6
90252	55	3,3	6
90222	65	3,8	6
90242	100	6,0	6
90262	150	8,9	6
90282	200	11,6	6

5.1 CUBETAS GASTRONORM / GASTRONORM CONTAINERS / BACS GASTRONORME / GASTRONORM BEHÄLTER

SP3

GASTRONORM INOX 18/10 /
18/10 ST/STEEL GASTRONORM /
GASTRONORME INOX 18/10 /
GASTRONORM EDELSTAHL 18/10

2/4 530 x 162 mm

18/10



REF	H mm	Lts	
90502	20	-	6
90512	30	2,4	6
90552	55	3,1	6
90522	65	3,7	6
90542	100	5,7	3
90562	150	8,2	3

1/3 325 x 176 mm

18/10

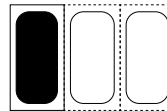

REF	H mm	Lts	
90302	20	-	6
90312	40	1,6	6
90352	55	2,0	6
90322	65	2,4	6
90342	100	3,7	6
90362	150	5,5	6
90382	200	7,1	3

1/4 265 x 162 mm

18/10

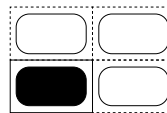

REF	H mm	Lts	
90402	20	-	6
90412	40	1,1	6
90452	55	1,5	6
90422	65	1,7	6
90442	100	2,6	6
90462	150	3,8	6
90482	200	4,8	3

1/6 176 x 162 mm

18/10

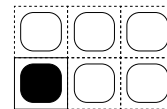

REF	H mm	Lts	
90622	65	1,1	6
90642	100	1,6	6
90662	150	2,3	6
90682	200	3,0	6

1/9 176 x 108 mm

18/10

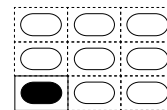

REF	H mm	Lts	
90922	65	0,60	6
90942	100	0,80	6

93100 Tapa / Lid / Couvercle / Deckel

18/10



REF	Mod	
93100	1/1	6
93110	2/3	6
93200	1/2	6
93500	2/4	6
93300	1/3	6
93400	1/4	6

1/1 530 x 325 mm

18/10

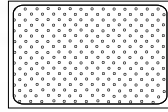

REF	H mm	
90013	40*	6
90053	55*	6
90023	65*	6
90043	100**	6
90063	150**	6

*Fondo perforado. **Fondo y laterales perforados.
*Perforated bottom. **Perforated bottom and sides.
*Fond perforé. **Fonds et latéraux perforés.
*Gelochter Boden. **Boden und Seiten gelocht.

1/2 325 x 265 mm

18/10

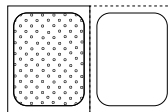

REF	H mm	
90213	40*	6
90223	65*	6
90243	100**	6
90263	150**	6

*Fondo perforado. **Fondo y laterales perforados.
*Perforated bottom. **Perforated bottom and sides.
*Fond perforé. **Fonds et latéraux perforés.
*Gelochter Boden. **Boden und Seiten gelocht.

TAPAS Y FONDOS PERFORADOS, SE
PUEDEN UTILIZAR LOS DE LA GAMA
DE CUBETAS INOX.
Fondos hasta 100 mm de profundidad.

LIDS AND FALSE BOTTOMS,
USE THE SAME AS OUR
STANDARD RANGE
False bottoms just to 100 mm depth.

COUVERCLES AND EGOUTTOIRS,
UTILIZER LES MEMES QUE LA
GAMME STANDARD
Egouttoirs jusqu'à 100 mm profondeur.

GELÖCHTE DECKEL UND BÖDEN,
ES KÖNNEN DIE AUS DER
EDELSTAHLBEHÄLTER-REIHE
VERWENDET WERDEN
Tiefen bis 100 mm.

VER PRODUCTOS EN / SEE PRODUCTS ON / VOIR PRODUITS EN PAGE / SIEHE PRODUKTE IN

TAPA /
LID /
COUVERCLE /
DECKEL

P. 455



VER PRODUCTOS EN / SEE PRODUCTS ON / VOIR PRODUITS EN PAGE / SIEHE PRODUKTE IN

SUPER SHAPES

P. 412



5.1 CUBETAS GASTRONORM / GASTRONORM CONTAINERS / BACS GASTRONORME / GASTRONORM BEHÄLTER



GASTRONORM INOX 18/10 /
18/10 ST/STEEL GASTRONORM /
GASTRONORME INOX 18/10 /
GASTRONORM EDELSTAHL 18/10

Tapa Polinorm® / Polinorm® Lid / Couvercle Polinorm® / Polinorm® Deckel

PATENTED / EXCLUSIVE



Cubetas GN inox, PC, sin Bisfenol-A y PP. No aptas para la gama SP3 /
St/Steel, PC, Bisphenol-A FREE and PP GN containers. Not for SP3 range /
Bacs GN inox, PC, sans Bisphénol-A et PP. Pas pour la gamme SP3 /
GN Behälter rostfrei, PC, ohne Bisfenol-A und PP. Edelstahlbehälter GN, PC,
ohne Bisphenol-A und PP. Nicht geeignet für SP3

REF	Mod	
P110.0 + COLOR	1/1	30
P120.0 + COLOR	1/2	60
P130.0 + COLOR	1/3	30
P140.0 + COLOR	1/4	30
P160.0 + COLOR	1/6	60
P190.0 + COLOR	1/9	30

Ref. color tapa /
Ref. colour lid /
Ref. couleur couvercle /
Art.Nr. Deckelfarbe



Tapa / Lid / Couvercle / Deckel

18/10



REF	Mod	
P110.000	1/1	1
P230.000	2/3	1
P120.000	1/2	1
P130.000	1/3	1
P140.000	1/4	1
P160.000	1/6	1
P190.000	1/9	1

Tapa plana sin asa / Flat lid without handle / Couvercle plat sans anse / Flacher Deckel ohne Griff



REF	Mod	
P110.005	1/1	1
P120.005	1/2	1

Tapa hermética / Hermetic lid / Couvercle étanche / Hermetischer Deckel

18/10



Detalle silicona
Silicone joint
Joint silicone
Detail Silikon



REF	Mod	
P110.004	1/1	1
P120.004	1/2	1
P130.004	1/3	1
P140.004	1/4	1
P160.004	1/6	1

Tapa orificio asas / Lid with splits for handles / Couvercle avec encoche pour anses / Deckel mit Öffnung für Griffe

18/10



REF	Mod	
P110.001	1/1	1
P230.001	2/3	1
P120.001	1/2	1
P130.001	1/3	1
P140.001	1/4	1
P160.001	1/6	1

Tapa orificio cacillo / Lid with split for ladle / Couvercle avec encoche pour louche / Deckel mit Öffnung für Löffel

18/10



REF	Mod	
P110.002	1/1	1
P120.002	1/2	1
P130.002	1/3	1
P140.002	1/4	1
P160.002	1/6	1

P100.002P Presentador 6 cubetas GN 1/6 inox / St/Steel stand 6 slots GN 1/6
Support bacs pour 6 GN 1/6 inox / Edelstahl Ständer für 6 GN Behälter 1/6

REF		
P100.002P		1

No incluye cubetas
Containers not included
Bacs non inclus
Behälter nicht inklusive



P100.004P Presentador cubetas GN / Stand for GN containers /
Support pour bacs GN / Ständer für GN Behälter

REF		
P100.004P	Soporte solo / Only stand / Support seul / Nur Ständer	1



REF	CONJUNTO / SET / LOT / SET	
P100.005P	6 - GN 1/9 65 mm	1
P100.006P	6 - GN 1/9 100 mm	1
P100.008P	4 - GN 1/6 100 mm	1

Permiten sostener / It can contain /
Il peut contenir / Einsetzmöglichkeiten

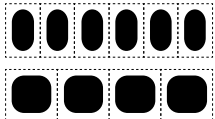

6-GN 1/9 En profundidades 65 y 100 mm
65 or 100 mm deep
Profondeurs 65 ou 100 mm
4-GN 1/6 In Tiefen von 65 und 100 mm

Adaptable a cubetas GN policarbonato y polipropileno
Adjustable to GN container in polycarbonate and polypropylene
Adapté à bacs GN en polycarbonate et polypropylène
Passend für GN Behälter aus Polycarbonat und Polypropylen

P100.003P Soporte para tapas GN / Stand for GN lids /
Support pour couvercles GN / Ständer für GN Deckel

REF	A cm	B cm	C cm	
P100.003P	27	31	27	1

Para 6 tapas
For 6 lids
Pour 6 couvercles
Für 6 Deckel

Distancia entre varillas 2,5 cm
Distance between wires 2,5 cm
Distance entre fils 2,5 cm
Abstand zwischen den Stäben 2,5 cm

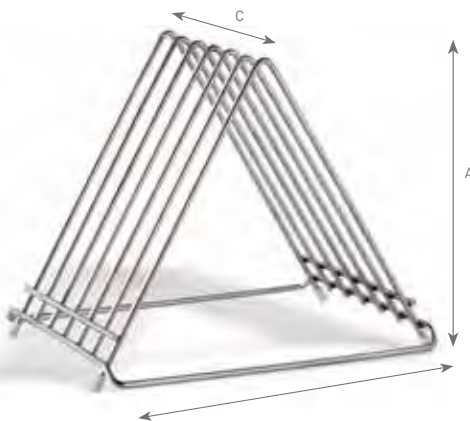

IDEA!

Ideal para tablas de corte. Ver página 138-140
Perfect for cutting boards. Refer to page 138-140
Ideal pour planches à découper. Voir page 138-140
Ideal für Schneidbretter. Siehe Seiten 138-140

5.3 CUBETAS GASTRONORM / GASTRONORM CONTAINERS / BACS GASTRONORME / GASTRONORM BEHÄLTER

COMPLEMENTOS GASTRONORM / GASTRONORM ACCESSORIES / ACCESSOIRES GASTRONORME / GASTRONORM ASSESSOIRES



+232,2°C

PATENTED EXCLUSIVE

ESPAÑOL

Fija la tapa, el papel de aluminio o el papel film, a la cubeta, para un transporte y almacenamiento seguro. Apta para lavavajillas. Fácil de usar.

ENGLISH

Attach the lid, aluminium foil or cling film to the tray for secure transport or storage. Dishwasher safe. Easy to use.

FRANÇAIS

Fixe le couvercle, le papier d'aluminium ou le film alimentaire au bac pour transport et stockage de façon sûre. Va au lave-vaisselle. Facile à utiliser.

DEUTSCH

Befestigen Sie den Deckel, die Alu- oder Frischhaltefolie am Behälter für einen sicheren Transport und eine sichere Lagerung. Spülmaschinengeeignet. Einfache bedienung



Scan me



N-0001B Banda selladora silicona GN. Negra / GN Pan Band. Black / Bande à silicone GN. Noir / GN-Silikon-Band. Schwarz /



+232,2°C

PATENTED EXCLUSIVE



REF	TIPO / TYPE	
N-0001B	1/1	24
N-0002B	1/2	24
N-0003B	1/3	24
N-0006B	1/6	24

VER PRODUCTOS EN / SEE PRODUCTS ON / VOIR PRODUITS EN PAGE / SIEHE PRODUKTE IN

1/1

BANDEJA GN ANTIADHERENTE / NON-STICK GN PAN TRAY / PLAQUE GN ANTI-ADHÉSIVE / ANTIHAFT TABLETT GN

ALUMINIO / ALUMINIUM

P. 70





PATENTED / EXCLUSIVE



ESPAÑOL

Cubetas GN con fondo difusor: únicas, adaptadas a la cocción en placas de inducción mediante fondo sandwich (inox-alu-inox).

ENGLISH

GN containers with sandwich base, suitable for cooking directly on any kind of stoves including induction.

FRANÇAIS

Bacs GN avec fond thermo-diffuseur apte sur tout type de cuisinières, surtout en induction.

DEUTSCH

GN Behälter mit Sandwichboden: Einzigartig, Geeignet für das Kochen auf Induktionskochfeldern Mittels Sandwichboden.



**Cubeta GN con fondo difusor / Sandwich bottom GN container /
Bac GN avec fond thermo-diffuseur / GN Behälter mit Sandwichboden**



PATENTED / EXCLUSIVE



INOX - ST/STEEL
EDELSTAHL
18/10



REF	TIPO / TYPE	H mm	Lts	
P110.6F1	1/1	65	8,30	1
P111.0F1	1/1	100	14,20	1
P111.5F1	1/1	150	20,20	1
P120.6F1	1/2	65	4,10	1

**Cubeta GN con fondo difusor y asas / Sandwich bottom GN container with handles /
Bac GN avec fond thermo-diffuseur et anses / GN Behälter mit Sandwichboden und Griffen**



PATENTED / EXCLUSIVE



INOX - ST/STEEL
EDELSTAHL
18/10



REF	TIPO / TYPE	H mm	Lts	
P111.0F2	1/1	100	14,20	1
P111.5F2	1/1	150	20,20	1

VER PRODUCTOS EN / SEE PRODUCTS ON / VOIR PRODUITS EN PAGE / SIEHE PRODUKTE IN

**CUBETA GN ANTIADHERENTE /
NON-STICK GN CONTAINER /
BAC GN ANTI-ADHÉSIVE /
GN BEHÄLTER ANTIHAFT**



P. 406

5.5 CUBETAS GASTRONORM / GASTRONORM CONTAINERS / BACS GASTRONORME / GASTRONORM BEHÄLTER

GASTRONORM POLICARBONATO /
POLYCARBONATE GASTRONORM /
GASTRONORME POLYCARBONATE /
GASTRONORM POLYCARBONAT



- 40 °C
 + 130 °C

ESPAÑOL

Utilización: almacenamiento de productos a granel, ingredientes varios en neveras o cámaras frigoríficas.
Ideales para presentación en buffets fríos.

ENGLISH

Use to store bulk products and ingredients in coolers, freezers or pantry.
Highly recommended for transportation and microwaves cooking.

FRANÇAIS

Utilisation : stockage de produits et ingrédients en vrac dans les unités réfrigérées ou placards.
Idéal pour le transport et la cuisson en four micro-ondes.

DEUTSCH

Gebrauch: Lagerung von unverpackten Lebensmittel, Verschiedenen Zutaten in Kühlschränken oder Kühlkammern.
Ideal für die Präsentation des Kalten Buffets.

1/1 530 x 325 mm



REF	H mm	Lts	
P110.6C1	65	8,70	12
P111.0C1	100	13,30	12
P111.5C1	150	19,60	12
P112.0C1	200	25,50	6

1/2 325 x 265 mm

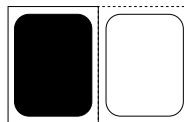

REF	H mm	Lts	
P120.6C1	65	4,00	30
P121.0C1	100	6,00	24
P121.5C1	150	8,70	24
P122.0C1	200	11,20	18

1/3 325 x 175 mm

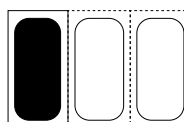

REF	H mm	Lts	
P130.6C1	65	2,35	30
P131.0C1	100	3,50	24
P131.5C1	150	5,00	24
P132.0C1	200	6,35	18

1/4 265 x 162 mm

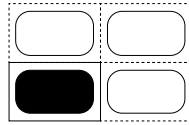

REF	H mm	Lts	
P140.6C1	65	1,65	18
P141.0C1	100	2,46	18
P141.5C1	150	3,47	12

1/6 176 x 162 mm

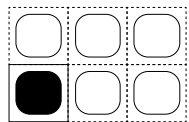

REF	H mm	Lts	
P160.6C1	65	0,95	30
P161.0C1	100	1,40	24
P161.5C1	150	1,95	24

1/9 176 x 108 mm

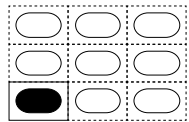

REF	H mm	Lts	
P190.6C1	65	0,54	30
P191.0C1	100	0,77	30

Tapa policarbonato / Polycarbonate lid / Couvercle Polycarbonate / Polycarbonat Deckel



REF	Mod	
P110.0C1	1/1	30
P120.0C1	1/2	60
P130.0C1	1/3	30
P140.0C1	1/4	30
P160.0C1	1/6	60
P190.0C1	1/9	30

Fondo perforado / Perforated bottom / Fond perforé / Gelochter Boden



REF	Mod	
P115.0C1	1/1	36
P125.0C1	1/2	24
P135.0C1	1/3	24
P145.0C1	1/4	30
P165.0C1	1/6	30

Tapa Polinorm® / Polinorm® Lid / Couvercle Polinorm® / Polinorm® Deckel

PATENTED EXCLUSIVE



REF	Mod	
P110.0 + COLOR	1/1	30
P120.0 + COLOR	1/2	60
P130.0 + COLOR	1/3	30
P140.0 + COLOR	1/4	30
P160.0 + COLOR	1/6	60
P190.0 + COLOR	1/9	30

Ref. color tapa /
Ref. colour lid /
Ref. couleur couvercle /
Art.Nr. Deckelfarbe



Adaptable a / Adjustable to / Adaptable à / Einsetzbar:

Cubetas GN inox, PC, sin Bisfenol-A y PP. No aptas para la gama SP3 /
St/Steel, PC, Bisphenol-A FREE and PP GN containers. Not for SP3 range /
Bacs GN inox, PC, sans Bisphénol-A et PP. Pas pour la gamme SP3 /
Edelstahlbehälter GN, PC, ohne Bisphenol-A und PP. Nicht geeignet für SP3

5.6 CUBETAS GASTRONORM / GASTRONORM CONTAINERS / BACS GASTRONORME / GASTRONORM BEHÄLTER

CUBETAS GASTRONORM SIN BISFENOL-A / GASTRONORM CONTAINERS, BISPHENOL-A FREE / BACS GASTRONORME SANS BISPHÉNOL-A / GASTRONORM BEHÄLTER OHNE BISFENOL-A



● - 40 °C
● + 90 °C

ESPAÑOL

Cubetas en copoliéster sin Bisfenol-a (100% BPA FREE). Es un material alternativo al policarbonato. Conformes con la norma europea en 631.1 (compatible con los equipos y aparatos gastronorm). Excelente transparencia y resistencia a los impactos. Ideales para almacenar productos en cámaras frigoríficas, de preparación. Cubetas apilables /

ENGLISH

Containers made of copolyester without Bisphenol-a (100% BPA FREE). An alternative material to polycarbonate. Complies with european standard en 631.1 (compatible with gastronorm systems and appliances) excellent transparency and impact resistance. Ideal for storing products in cold rooms, for preparation. Stackable containers /

FRANÇAIS

Bacs en copolyester sans Bisphénol-a (100% BPA FREE). Il s'agit d'un matériau alternatif au polycarbonate. Conformes à la norme européenne en 631.1 (compatible avec les machines et appareils gastronorm). Excellentes transparence et résistance aux chocs. Idéales pour emmagasiner des produits dans des chambres froides, de préparation. Cuvettes empilables.

DEUTSCH

Behälter aus COPOLYESTER ohne Bisfenol-a (100% BPA FREE). Es ist ein alternatives Material zu polycarbonat. Entsprechend der europäischen Norm 631.1 (Kompatibel mit allen Systemen und Maschinen Gastronorm). Exzellente Transparenz und resistenz Gegen Stösse. Ideal zum Lagern von produkten in Kühlkammern, Zur Vorbereitung. Behälter stapelbar.

1/1 530 x 325 mm



REF	H mm	Lts	
P110.6BF	65	8,70	12
P111.0BF	100	13,30	12
P111.5BF	150	19,60	12
P112.0BF	200	25,50	6

1/2 325 x 265 mm

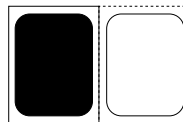

REF	H mm	Lts	
P120.6BF	65	4,00	30
P121.0BF	100	6,00	24
P121.5BF	150	8,70	24
P122.0BF	200	11,20	18

1/3 325 x 175 mm

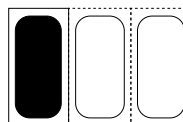

REF	H mm	Lts	
P130.6BF	65	2,35	18
P131.0BF	100	3,50	12
P131.5BF	150	5,00	12
P132.0BF	200	6,35	6

1/4 265 x 162 mm

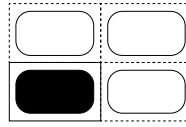

REF	H mm	Lts	
P140.6BF	65	1,65	18
P141.0BF	100	2,46	18
P141.5BF	150	3,47	12

1/6 176 x 162 mm

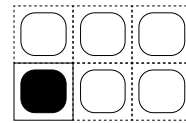

REF	H mm	Lts	
P160.6BF	65	0,95	30
P161.0BF	100	1,40	24
P161.5BF	150	1,95	24

1/9 176 x 108 mm

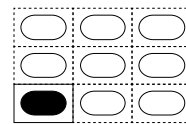

REF	H mm	Lts	
P190.6BF	65	0,54	30
P191.0BF	100	0,77	30

Tapa gastronorm / Gastronorm lid / Couvercle gastronorme / Gastronorm Deckel



REF	Mod	
P110.0BF	1/1	30
P120.0BF	1/2	60
P130.0BF	1/3	30
P140.0BF	1/4	30
P160.0BF	1/6	60
P190.0BF	1/9	30

Fondo perforado / Perforated bottom / Fond perforé / Gelochter Boden



REF	Mod	
P115.0BF	1/1	36
P125.0BF	1/2	24
P135.0BF	1/3	24
P145.0BF	1/4	30
P165.0BF	1/6	30

Tapa Polinorm® / Polinorm® Lid / Couvercle Polinorm® / Polinorm® Deckel

PATENTED EXCLUSIVE



REF	Mod	
P110.0 + COLOR	1/1	30
P120.0 + COLOR	1/2	60
P130.0 + COLOR	1/3	30
P140.0 + COLOR	1/4	30
P160.0 + COLOR	1/6	60
P190.0 + COLOR	1/9	30

Adaptable a / Adjustable to / Adaptable à / Einsetzbar:

Cubetas GN inox, PC, sin Bisfenol-A y PP. No aptas para la gama SP3 /
St/Steel, PC, Bisphenol-A FREE and PP GN containers. Not for SP3 range /
Bacs GN inox, PC, sans Bisphénol-A et PP. Pas pour la gamme SP3 /
Edelstahlbehälter GN, PC, ohne Bisphenol-A und PP. Nicht geeignet für SP3

Ref. color tapa /
Ref. colour lid /
Ref. couleur couvercle /
Art.Nr. Deckelfarbe



5.7 CUBETAS GASTRONORM / GASTRONORM CONTAINERS / BACS GASTRONORME / GASTRONORM BEHÄLTER



GASTRONORM POLIPROPILENO / POLYPROPYLENE GASTRONORM / GASTRONORME POLYPROPYLENE / POLYPROPYLEN GASTRONORM

PATENTED EXCLUSIVE



- 40 °C
 + 110 °C



ESPAÑOL

Utilización: almacenamiento de productos a granel, ingredientes varios en neveras o cámaras frigoríficas. Ideal para transporte y cocción en microondas.

ENGLISH

Use to store bulk products and ingredients in coolers, freezers or pantry. Highly recommended for transportation and micro-waves cooking.

FRANÇAIS

Utilisation: stockage de produits et ingrédients en vrac dans des unités réfrigérées OU PLACARDS. Idéal pour le transport et la cuisson en FOUR micro-ondes.

DEUTSCH

Gebrauch: Lagerung von unverpackten Lebensmittel, Verschiedenen Zutaten in Kühlschränken oder Kühlkammern. Ideal für den Transport oder zum Kochen in Mikrowellen.

Tapa Polinorm® / Polinorm® Lid / Couvercle Polinorm® / Polinorm® Deckel

PATENTED EXCLUSIVE



Adaptable a / Adjustable to / Adaptable à / Einsetzbar:

Cubetas GN inox, PC, sin Bisfenol-A y PP. No aptas para la gama SP3 / St/Steel, PC, Bisphenol-A FREE and PP GN containers. Not for SP3 range / Bacs GN inox, PC, sans Bisphénol-A et PP. Pas pour la gamme SP3 / Edelstahlbehälter GN, PC, ohne Bisphenol-A und PP. Nicht geeignet für SP3

REF	Mod	
P110.0 + COLOR	1/1	30
P120.0 + COLOR	1/2	60
P130.0 + COLOR	1/3	30
P140.0 + COLOR	1/4	30
P160.0 + COLOR	1/6	60
P190.0 + COLOR	1/9	30

Ref. color tapa /
Ref. colour lid /
Ref. couleur couvercle /
Art.Nr. Deckelfarbe



1/1 530 x 325 mm



REF	H mm	Lts	
P110.6P1	65	8,70	12
P111.0P1	100	13,30	12
P111.5P1	150	19,60	12
P112.0P1	200	25,50	6

1/2 325 x 265 mm

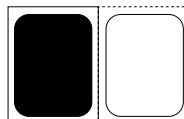

REF	H mm	Lts	
P120.6P1	65	4,00	30
P121.0P1	100	6,00	24
P121.5P1	150	8,70	24
P122.0P1	200	11,20	18

1/3 325 x 175 mm

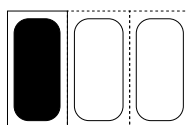

REF	H mm	Lts	
P130.6P1	65	2,35	18
P131.0P1	100	3,50	12
P131.5P1	150	5,00	12
P132.0P1	200	6,35	6

1/4 265 x 162 mm

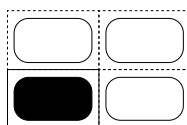

REF	H mm	Lts	
P140.6P1	65	1,65	18
P141.0P1	100	2,46	18
P141.5P1	150	3,47	12

1/6 176 x 162 mm

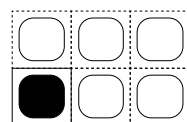

REF	H mm	Lts	
P160.6P1	65	0,95	30
P161.0P1	100	1,40	24
P161.5P1	150	1,95	24

1/9 176 x 108 mm

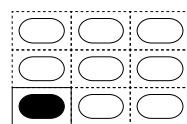

REF	H mm	Lts	
P190.6P1	65	0,54	30
P191.0P1	100	0,77	30

Tapa policarbonato / Polycarbonate lid / couvercle Polycarbonate / Polycarbonat Deckel



REF	Mod	
P110.0C1	1/1	30
P120.0C1	1/2	60
P130.0C1	1/3	30
P140.0C1	1/4	30
P160.0C1	1/6	60
P190.0C1	1/9	30

Fondo perforado / Perforated bottom / Fond perforé / Gelochter Boden



REF	Mod	
P115.0P1	1/1	36
P125.0P1	1/2	24
P135.0P1	1/3	24
P145.0P1	1/4	30
P165.0P1	1/6	30



GASTRONORM POLIPROPILENO / POLYPROPYLENE GASTRONORM / GASTRONORME POLYPROPYLÈNE / POLYPROPYLEN GASTRONORM



- 40 °C
 + 110 °C

V I O L E T
C O L L E C T I O N



ESPAÑOL

Utilización: almacenamiento de productos a granel, ingredientes varios en neveras o cámaras frigoríficas. Ideal para transporte y cocción en microondas.

ENGLISH

Use to store bulk products and ingredients in coolers, freezers or pantry. Highly recommended for transportation and micro-waves cooking.

Cubetas Gastronorm / Gastronorm containers /
Bacs Gastronorme / Gastronorm behälter



REF	TIPO / TYPE	H mm	Lts	
P111.5P6	1/1	150	19,60	1
P121.5P6	1/2	150	8,70	1
P131.5P6	1/3	150	5,00	1
P161.5P6	1/6	150	1,95	1

FRANÇAIS

Utilisation: stockage de produits et ingrédients en vrac dans des unités réfrigérées ou placards. Idéal pour le transport et la cuisson en four micro-ondes.

DEUTSCH

Gebrauch: lagerung von unverpackten lebensmittel, verschiedenen zutaten in kühl-schränken oder kühlkammern. Ideal für den transport oder zum kochen in mikrowellen.

Tapa Polinorm® / Polinorm® Lid /
Couvercle Polinorm® / Polinorm® Deckel



REF	Mod	
P110.0P6	1/1	30
P120.0P6	1/2	60
P130.0P6	1/3	30
P160.0P6	1/6	60

Adaptable a / Adjustable to /
Adaptable à / Einsetzbar:

Ref. color tapa /
Ref. colour lid /
Ref. couleur couvercle /
Art.Nr. Deckelfarbe

P6

Cubetas GN inox, PC, sin Bisfenol-A y PP. No aptas para la gama SP3 /
St/Steel, PC, Bisphenol-A FREE and PP
GN containers. Not for SP3 range /
Bacs GN inox, PC, sans Bisphénol-A et
PP. Pas pour la gamme SP3 /
Edelstahlbehälter GN, PC, ohne Bisphenol-A und PP. Nicht geeignet für SP3



CUBETAS GN /
GN CONTAINERS /
BACS GN



**CESTAS PARA VAJILLA /
DISHWASHER RACKS /
CASIERS À VAISSELLE /
SPÜLMASCHINENKÖRBE**

6.1	CESTAS BASE Y SUPLEMENTOS / RACKS AND EXTENDERS / PANIERS BASE ET RÉHAUSSE / BASISKÖRBE UND ERWEITERUNGEN	180
6.2	COMPLEMENTOS / COMPLEMENTS / COMPLÉMENTS / ZUBEHÖR	186
6.3	CESTAS PARA PLATOS / PLATE RACKS / CASIERS ASSIETTES / TELLERSPÜLKÖRBE	188
6.4	CESTAS SIGNATURE / SIGNATURE RACKS / CASIERS SIGNATURE / SPÜLKÖRBE SIGNATURE	192

FLAP RACK®

by **pujadas**
A VOLLRATH® COMPANY

Sistema de montaje y desmontaje fácil, seguro y sencilla personalización /
Easy assembly and disassembly system, safe and simple customization /
Système de montage et démontage facile, sûr et de simple personnalisation /
Einfaches montage- und demontagesystem, sichere und einfache personalisierung

Apilables con otras cestas del mercado, refuerzo de doble pared (anti-golpes) /
Stackable with other market racks reinforced double-wall (anti-shock) /
Empilable avec d'autres paniers du marché, renforcé avec double paroi (anti-choc) /
Stapelbar mit anderen Körben auf dem Markt, verstärkt mit Doppelwand (anti-stoss)

ABIERTA / OPENED / OUVERT / OFFEN

APERTURAS PARA MÁXIMA LIMPIEZA
OPENINGS FOR MAXIMUM CLEANING
OUVERTURES POUR UN NETTOYAGE PERFORMANT
ÖFFNUNGEN FÜR MAXIMALE REINIGUNG

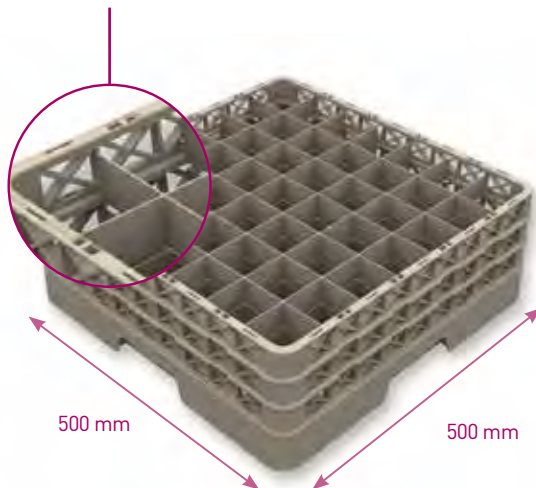

CERRADA / CLOSED / FERMÉ / GESCHLOSSEN

IDEALES PARA EL TRANSPORTE Y EL ALMACENAMIENTO
IDEAL FOR TRANSPORTING AND STORING
IDÉAL POUR LE TRANSPORT ET LE STOCKAGE
IDEAL FÜR DEN TRANSPORT UND LAGERUNG

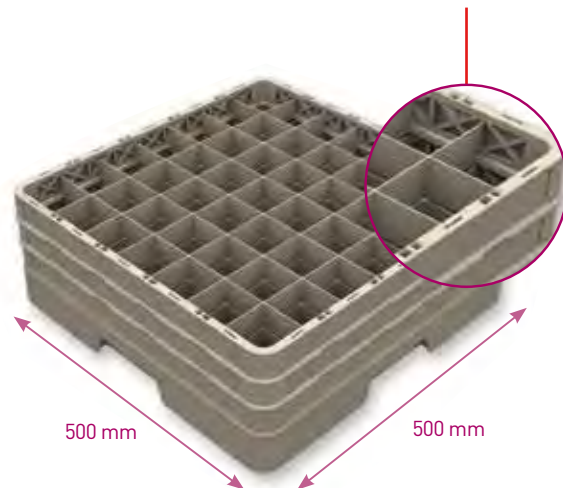

ESCOGER LO BUENO Y LO MEJOR A LA VEZ* /
GET THE BEST OF BOTH WORLDS* /
LE BON ET LE MEILLEUR À LA FOIS* /
NEHMEN SIE DAS GUTE UND DAS BESTE AUF EINMAL*

FLAP-RACK®: fácil montaje / desmontaje
FLAP-RACK®: easy to assembly / disassembly
FLAP-RACK®: facile à monter / démonter
FLAP-RACK®: Einfache Montage / Demontage

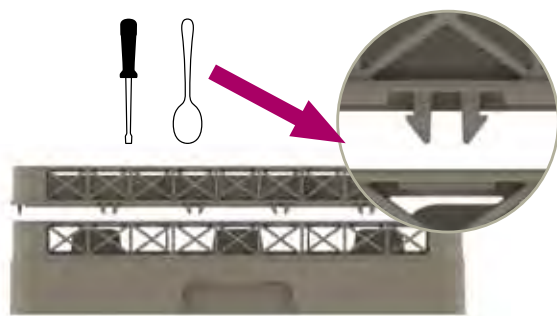

LAVADO: Mayor limpieza
WASHING: Higher cleaning
LAVAGE: MEILLEUR NETTOYAGE
REINIGUNG: Bessere Reinigung



TRANSPORTE: Mayor seguridad
TRANSPORT: Higher security
TRANSPORT: Plus de sécurité
TRANSPORT: Höhere Sicherheit



ALMACENAMIENTO: Mayor Higiene
STORING: Higher hygiene
STOCKAGE: Plus hygiénique
LAGERUNG: Höhere Hygiene

* Copolímero altamente resistente a sustancias químicas y temperaturas de hasta 95 °C.
* Copolymer highly resistant to chemical products and temperatures up to 95 °C.
* Copolymère très résistant aux produits chimiques et à températures jusqu'à 95 °C.
* Copolymer höchster Widerstand gegen chemische Substanzen und Temperaturen bis zu 95 °C.

FLAP RACK® by pujadas®

A VOLLRATH® COMPANY



Sistema patentado que permite cerrar y abrir las paredes de las cestas y extensiones fácilmente

System patented allows the walls on both bases and extenders to be closed or open easily

Système breveté qui permet d'ouvrir ou de fermer facilement les parois des CASIERS et des RÉHAUSSES

Patentiertes System, welches das einfache öffnen und Schliessen der Spülkorbwände und die Vergrößerung erlaubt



FLAP IDENTIFICADOR

Identificador de colores para cestas y extensiones completamente cerradas. Disponible en 6 colores. Posibilidad de marcar logo cliente.

Colour identification for completely closed racks and extensions. Available in 6 colours. Possible personalisation.

Identificateur en couleurs pour casiers et réhaussees complètement fermés. Disponible en 6 couleurs. Personnalisation possible.

Farbidentifikation für Spülkörbe und Vergrößerungen komplett geschlossen. Erhältlich in 6 Farben. Möglichkeit der Markierung mit dem Firmenlogo.



F1 marrón
brown
marron
braun



F4 amarillo
yellow
jaune
gelb

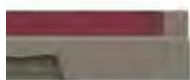

F2 burdeos
burgundy
bordeaux
bordeauxrot

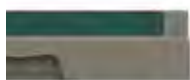

F5 verde
green
vert
grün

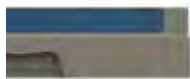

F3 azul
blue
bleu
blau

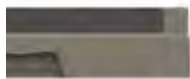

F6 marrón oscuro
dark brown
marron foncé
dunkelbraun



Logo o texto impreso / Printed logo or text /
Logo ou texte imprimé / Logo oder Text gedruckt



Logo o texto estampado / Hot stamped logo or text /
Logo ou texte gravé / Logo oder Text gestempelt



501F Flap

FLAP RACK®

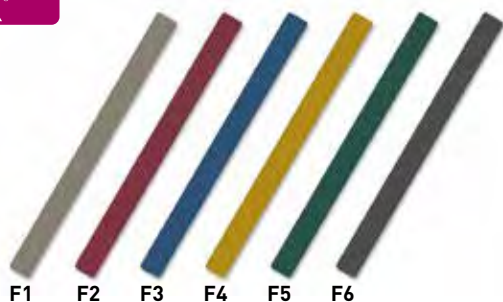

REF	COLOR / COLOUR / COULEUR / FARBE	
P501 F1	Marrón / Brown / Marrón / Braun	24
P501 F2	Burdeos / Burgundy / Bordeaux / Bordeauxrot	24
P501 F3	Azul / Blue / Bleu / Blau	24
P501 F4	Amarillo / Yellow / Jaune / Gelb	24
P501 F5	Verde / Green / Vert / Grün	24
P501 F6	Marrón oscuro / Dark brown / Marrón foncé / Dunkelbraun	24

6.1 CESTAS PARA VAJILLA / DISHWASHER RACKS / CASIERS À VAISSELLE / SPÜLMASCHINENKÖRBE

T-VERSION

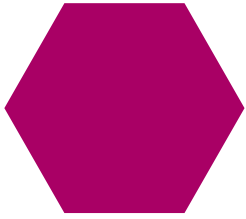

DISEÑADAS CON UN 17-30% MÁS DE CAPACIDAD PARA VASOS Y COPAS QUE LAS CESTAS TRADICIONALES

DESIGNED TO HOLD 17-30% MORE GLASSWARE THAN A TRADITIONAL RACK

CONÇUS POUR CONTENIR DE 17 À 30 % DE VERRES EN PLUS QU'UN CASIER TRADITIONNEL

NIMMT 17-30 % MEHR GLASER AUF ALS KONVENTIONELLE SPULKORBE

EXTENSORES A PRESIÓN

No se sueltan con el tiempo

No se aceptan devoluciones de cestas montadas

SNAP-FIT EXTENDERS

Will not loosen or come apart over time

Assembled racks can not be refunded

LES EXTENSIONS À ENCLÈCHEMENT

No se délogeront pas au fil des ans

Tout retour de casiers assemblés n'est pas accepté

AUFSCHNAPPVERLÄNGERUNGEN

Lösen sich im Laufe der Zeit nicht voneinander ab

Montierte Körbe können nicht zurückgegeben werden

DISEÑO DE PERFIL ABIERTO

Permite un lavado y secado de arriba a abajo y de lado a lado

OPEN PROFILE DESIGN

Allows top-to-bottom and side-to-side washing and drying

LE CONCEPT À PROFIL OUVERT

Permet un lavage et un séchage de haut en bas et d'un côté à l'autre

OFFENES DESIGN

Ermöglicht Waschen und Trocknen von oben nach unten und von einer Seite zur anderen

MANEJO CÓMODO

Con asas en los cuatro lados

CONVENIENT HANDLING

With handles an all four sides

MANIPULATION PRATIQUE G

râce aux poignées des quatre côtés

PRAKTISCHE TRAGEVORRICHTUNG

Mit Griffen an allen vier Seiten

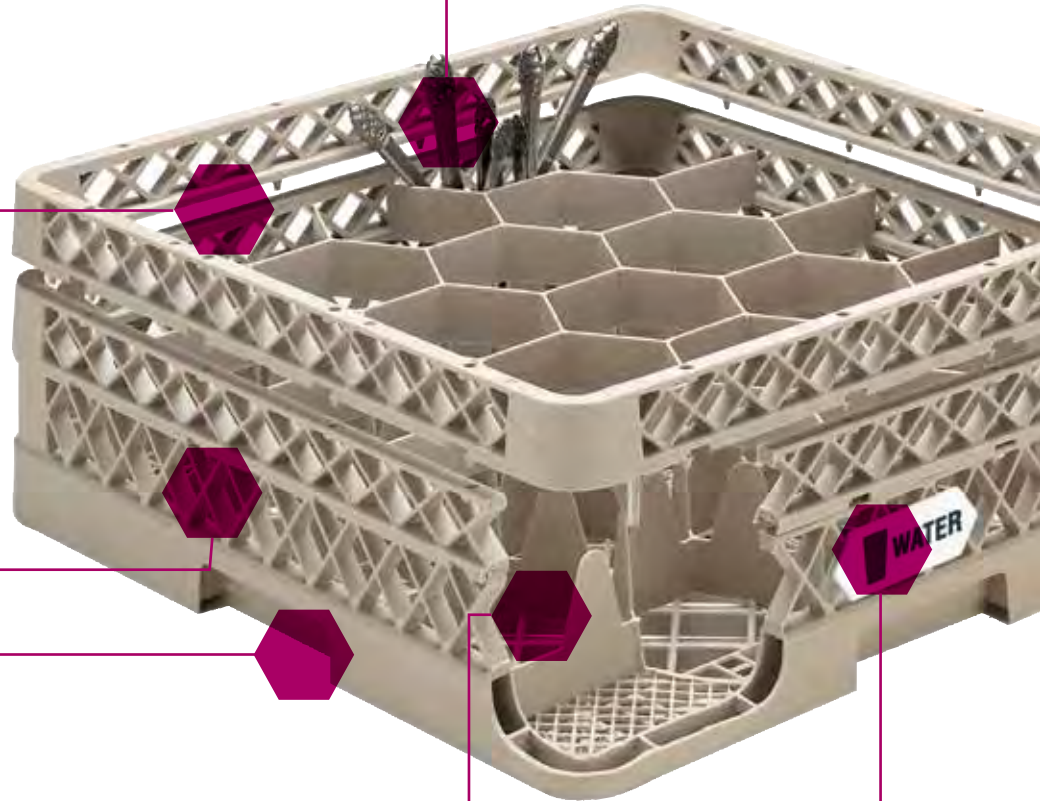

LOS COMPARTIMENTOS LATERALES PEQUEÑOS aceptan cubiertos, saleros, potes, ...

SMALL SIDE COMPARTMENTS hold flatware, salt shakers, ramekins, ...

LES PETITS COMPARTIMENTS LATÉRAUX contiennent couverts, salières, ramequins, ...

KLEINA SEITENFÄCHER nehmen Besteck, Salzstreuer, Auflaufformen und mehr auf

LOS DIVISORES INCORPORADOS brindan una protección 100% vertical de los vasos y las copas

BUILT-IN BASE RACK DIVIDERS provide 100% vertical glassware protection

LES PARTITIONS DE CASIER DE BASE INTÉGRÉES offrent une protection des verres 100% verticale

INTEGRIERTE KORBBODEN-TRENNEINSÄTZE bieten 100-prozentigen vertikalen Schutz vor Glasbruch

CLIPS DE IDENTIFICACIÓN DE COLORES para facilitar la identificación

COLOUR IDENTIFICATION CLIP for easy identification

CLIPS IDENTIFICATEUR EN COULEURS pour une identification plus facile

FARBIDENTIFIKATION zur einfachen Kennzeichnung

CLIP Clip identificación / Clip tags / Clip d'identification / Klippidentifizierung

T-VERSION

C1/01

Marrón / Brown / Marron / Braun

C2/02

Rojo / Red / Rouge / Rot

C6/03

Naranja / Orange / Orange / Orange

C3/04

Azul / Blue / Bleu / Blau

C7/05

Blanco / White / Blanc / Weiss

C8/06

Negro / Black / Noir / Schwarz

C4/08

Amarillo / Yellow / Jaune / Gelb

C5/19

Verde / Green / Vert / Grün

C9/32

Beige / Beige / Beige / Beige



REF	Color / Colour	Icon
1009-01	Marrón	1
1009-02	Rojo	1
1009-03	Naranja	1
1009-04	Azul	1
1009-05	Blanco	1
1009-06	Negro	1
1009-08	Amarillo	1
1009-19	Verde	1
1009-32	Beige	1

	FLAP RACK®	T-VERSION	<i>Signature</i>
FLAPS	✓	✗	✗
CLIP IDENTIFICACIÓN / CLIP TAGS / CLIP D'IDENTIFICATION / KLIPPIDENTIFIZIERUNG	✗	✓	✓
CESTAS ABIERTAS / OPENED RACKS / PANIER OUVERTS / SPÜLKORB OFFENES	✓	✓	✓
CESTAS CERRADAS / CLOSED RACKS / PANIER FERMÉES / SPÜLKORB GESCHLOSSENES	✓	✗	✗
CESTAS MEDIO TAMAÑO / HALF-SIZE RACKS / CASIERS DEMI-TAILLE / SPÜLKÖRBE IN HALBGRÖßE	✗	✓	✗
DESMONTABLE / DISASSEMBLY / DÉMONTER / DEMONTAGE	✓	✗	✓
COMPARTIMENTOS / COMPARTMENTS / COMPARTIMENTS / FÄCHER 	✓	✓	✓
COMPARTIMENTOS / COMPARTMENTS / COMPARTIMENTS / FÄCHER 	✗	✓	✓
	✓	✓	✓

CESTAS VAJILLA /
DISHWASHER RACKS /
CASIERS VAISSELLE



6.1 CESTAS PARA VAJILLA / DISHWASHER RACKS / CASIERS À VAISSELLE / SPÜLMASCHINENKÖRBE

ABIERTAS / OPENED / OUVERTS / OFFEN

 Ø max. 151 mm

FLAP RACK



P5090
BASE 9 COMPART.



P5091
EXT. 9 COMPART.

REF	
P5090	6
P5091	12



 Ø max. 122 mm

T-VERSION



TR18
BASE 12 COMPART.



TRJ
EXT. 12 COMPART.

REF	
TR18	6
TRJ	12



 Ø max. 113 mm

FLAP RACK



P5160
BASE 16 COMPART.



P5161
EXT. 16 COMPART.

REF	
P5160	6
P5161	12



 Ø max. 100 mm

T-VERSION



TR11
BASE 20 COMPART.



TRG
EXT. 20 COMPART.

REF	
TR11	6
TRG	12



 Ø max. 89 mm

FLAP RACK



P5250
BASE 25 COMPART.

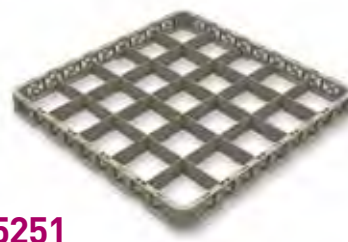

P5251
EXT. 25 COMPART.

REF	
P5250	6
P5251	12



 Ø max. 81 mm

T-VERSION



TR12
BASE 30 COMPART.



TRH
EXT. 30 COMPART.

REF	
TR12	6
TRH	12



 Ø max. 73 mm

FLAP RACK®



P5360
BASE 36 COMPART.



P5361
EXT. 36 COMPART.

REF	
P5360	6
P5361	12



 Ø max. 70 mm

T-VERSION



TR13
BASE 42 COMPART.



TRM
EXT. 42 COMPART.

REF	
TR13	6
TRM	12



 Ø max. 63 mm

FLAP RACK®



P5490
BASE 49 COMPART.

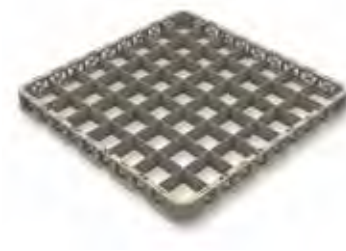

P5491
EXT. 49 COMPART.

REF	
P5490	6
P5491	12



CESTAS VAJILLA /
DISHWASHER RACKS /
CASIERS VAISSELLE

6.1 CESTAS PARA VAJILLA / DISHWASHER RACKS / CASIERS À VAISSELLE / SPÜLMASCHINENKÖRBE

MONTADAS ABIERTAS / OPENED ASSEMBLED / MONTÉS OUVERTS / OFFENE MONTAGE

∅ max. 151 mm

9 COMPART.

FLAP RACK®



REF	∆lmax. (mm)	H (mm)*
P5090 E1	120	140
P5090 E2	160	180
P5090 E3	200	220
P5090 E4	240	260
P5090 E5	280	300

∅ max. 122 mm

12 COMPART.

T-VERSION



REF	∆lmax. (mm)	H (mm)*
TR18 J	122	140
TR18 JJ	162	181
TR18 JJJ	200	222
TR18 JJJJ	240	262
TR18 JJJJJ	279	302

∅ max. 113 mm

16 COMPART.

FLAP RACK®



REF	∆lmax. (mm)	H (mm)*
P5160 E1	120	140
P5160 E2	160	180
P5160 E3	200	220
P5160 E4	240	260
P5160 E5	280	300

∅ max. 100 mm

20 COMPART.

T-VERSION



REF	∆lmax. (mm)	H (mm)*
TR11 G	122	140
TR11 GG	162	181
TR11 GGG	200	222
TR11 GGGG	240	262
TR11 GGGGG	279	302

∅ max. 89 mm

25 COMPART.

FLAP RACK®



REF	∆lmax. (mm)	H (mm)*
P5250 E1	120	140
P5250 E2	160	180
P5250 E3	200	220
P5250 E4	240	260
P5250 E5	280	300

 Ø max. 81 mm

30 COMPART.

T-VERSION



REF	∇ I _{max.} (mm)	H (mm)*
TR12 H	122	140
TR12 HH	162	181
TR12 HHH	200	222
TR12 HHHH	240	262
TR12 HHHHH	279	302

 Ø max. 73 mm

36 COMPART.

**FLAP
RACK®**



REF	∇ I _{max.} (mm)	H (mm)*
P5360 E1	120	140
P5360 E2	160	180
P5360 E3	200	220
P5360 E4	240	260
P5360 E5	280	300

 Ø max. 70 mm

42 COMPART.

T-VERSION



REF	∇ I _{max.} (mm)	H (mm)*
TR13 M	52	73
TR13 MM	91	114
TR13 MMM	130	156
TR13 MMMM	172	194

 Ø max. 63 mm

49 COMPART.

**FLAP
RACK®**



REF	∇ I _{max.} (mm)	H (mm)*
P5490 E1	120	140
P5490 E2	160	180
P5490 E3	200	220
P5490 E4	240	260
P5490 E5	280	300

* Altura total del conjunto
* Total set height
* Hauteur totale lot
* Gesamthöhe des Sets

VER PRODUCTOS EN / SEE PRODUCTS ON / VOIR PRODUITS EN PAGE / SIEHE PRODUKTE IN

**CARRO PARA CESTAS /
TROLLEY FOR DISHWASHER RACKS /
CHARIOT POUR CASIERS À VAISSELLE /
WAGEN FÜR SPÜLKÖRBE**



P. 212

∅ max. 151 mm

FLAP RACK



P5090 F1
BASE 9 COMPART.

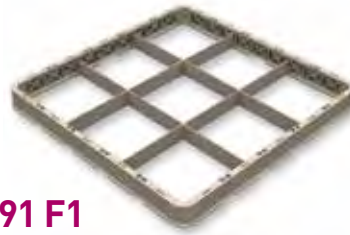

P5091 F1
EXT. 9 COMPART.

REF	
P5090 F1	6
P5091 F1	12

∅ max. 113 mm

FLAP RACK



P5160 F1
BASE 16 COMPART.



P5161 F1
EXT. 16 COMPART.

REF	
P5160 F1	6
P5161 F1	12

∅ max. 89 mm

FLAP RACK



P5250 F1
BASE 25 COMPART.



P5251 F1
EXT. 25 COMPART.

REF	
P5250 F1	6
P5251 F1	12

∅ max. 73 mm

FLAP RACK



P5360 F1
BASE 36 COMPART.



P5361 F1
EXT. 36 COMPART.

REF	
P5360 F1	6
P5361 F1	12

∅ max. 63 mm

FLAP RACK



P5490 F1
BASE 49 COMPART.

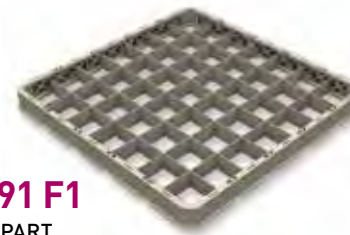

P5491 F1
EXT. 49 COMPART.

REF	
P5490 F1	6
P5491 F1	12

Indicar el código de color al final de la referencia.
Indicate the colour code at the end of the item reference.
Indiquer le code de couleur à la fin de la référence.
Angabe des Farbcodes am Ende der Artikelnummer.



F1



F2



F3



F4



F5



F6

FLAP RACK

 Ø max. 151 mm
9 COMPART.

**FLAP
RACK®**



REF	Δmax. (mm)	H (mm)*
P5090 E1F1	120	140
P5090 E2F1	160	180
P5090 E3F1	200	220
P5090 E4F1	240	260
P5090 E5F1	280	300

 Ø max. 113 mm
16 COMPART.

**FLAP
RACK®**



REF	Δmax. (mm)	H (mm)*
P5160 E1F1	120	140
P5160 E2F1	160	180
P5160 E3F1	200	220
P5160 E4F1	240	260
P5160 E5F1	280	300

 Ø max. 89 mm
25 COMPART.

**FLAP
RACK®**



REF	Δmax. (mm)	H (mm)*
P5250 E1F1	120	140
P5250 E2F1	160	180
P5250 E3F1	200	220
P5250 E4F1	240	260
P5250 E5F1	280	300

 Ø max. 73 mm
36 COMPART.

**FLAP
RACK®**



REF	Δmax. (mm)	H (mm)*
P5360 E1F1	120	140
P5360 E2F1	160	180
P5360 E3F1	200	220
P5360 E4F1	240	260
P5360 E5F1	280	300

 Ø max. 63 mm
49 COMPART.

**FLAP
RACK®**



REF	Δmax. (mm)	H (mm)*
P5490 E1F1	120	140
P5490 E2F1	160	180
P5490 E3F1	200	220
P5490 E4F1	240	260
P5490 E5F1	280	300

* Altura total del conjunto
* Total set height
* Hauteur totale lot
* Gesamthöhe des Sets

Indicar el código de color al final de la referencia.
Indicate the colour code at the end of the item reference.
Indiquer le code de couleur a la fin de la référence.
Angabe des Farbcodes am Ende der Artikelnummer.



F1



F2



F3



F4



F5



F6

**FLAP
RACK®**

P5002 Cesta universal / Open rack / Panier universel / Universalspülkorb

FLAP RACK®



P5002



P5001

REF	
P5002	6
P5001	12

Compatible con las cestas FlapRack®.
Compatible with FlapRack® dishwasher racks.
Compatible avec les casiers de lavage FlapRack®.
Kompatibel mit den Körbe FlapRack®.

P5000 Cesta para platos, bandejas y cubiertos / Plate, tray and cutlery baskets / Paniers pour plats, plateaux et couverts / Lagerbehälter und Körbe für Geschirr, Besteck und Tablett

FLAP RACK®

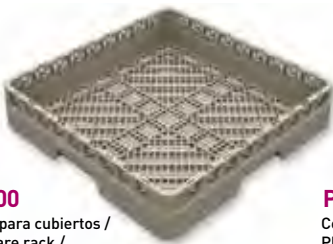

P5000
Cesta para cubiertos / Flatware rack / Panier a couverts / Besteckspülkorb

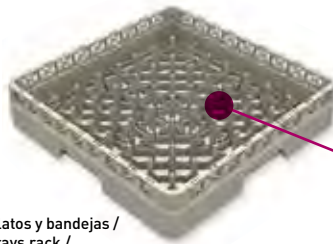

P5003
Cesta para platos y bandejas / Plates and trays rack / Panier pour assiettes et plateaux / Spülkorb für Teller und Tablett

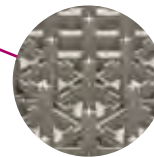

REF	
P5000	6
P5003	6

TR33 Tapa para cestas / Rack lid / Couvercle pour panier / Spülkorbdeckel

FLAP RACK®



REF	
TR33	6

P5062 Cesta para almacenar cubiertos / Basket for cutlery storage / Panier pour rangement couverts / Besteckkorb

FLAP RACK®



REF				H (mm)*	CAPACIDAD CUBIERTOS / CUTLERY STORAGE / CAPACITÉ COUVERTS / KORB FÜR BESTECKE	
P5062	23	26		400	1	

*Altura total del conjunto
Total set height
Hauteur totale lot
Gesamthöhe des Sets

Media cesta para cubiertos / Flatware basket / Demi-panier pour couverts / Spülkorbeinsatz für Besteck

FLAP RACK®

P5018
Con asa
With handle
Avec anse
Mit griff

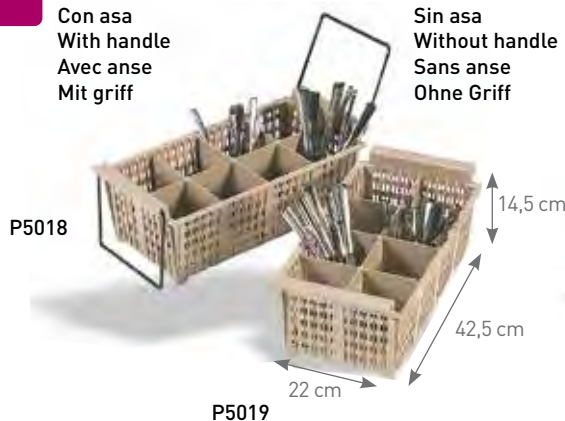

P5019
Sin asa
Without handle
Sans anse
Ohne Griff

P5004 / 52643
Cestillo para cubiertos
Flatware basket
Petit panier pour couverts
Kleiner Spülkorbeinsatz für Besteck



REF	
P5018	6
P5019	6
P5004	6
52643	12



CESTAS VAJILLA /
DISHWASHER BASKETS /
CASIERS VAISSELLE

FLAP RACK®

ESPAÑOL

Cestas especiales para platos: Ideales para el lavado, almacenamiento y transporte de platos. Perfectas para banquetes, hoteles, colectividades y empresas de alquiler de material para la hostelería. Reducen las roturas de platos, minimizan el coste del transporte y manipulación.

ENGLISH

Plate crate: Perfect dish washing, storing and transporting for banquets, hotels, institutions and catering equipment rental companies. They minimize the plate breakage, labour and handling cost

FRANÇAIS

Casiers pour assiettes: Idéales pour le lavage, stockage et transport d'assiettes. Parfaits pour banquets, hôtels, collectivités et sociétés de location de matériel pour l'hôtellerie. Ce type de casiers permet de réduire le nombre d'assiettes cassées ainsi qu'une diminution des coûts de transport et manipulation

DEUTSCH

Spülkörbe speziell für teller: ideal für die Reinigung, lagerung und transport der teller. perfekt für banketts, hotels, catering und Firmen, die gastronomiematerial vermieten. Weniger zerbrochene Teller, Minimierung der Transport- und Abwicklungskosten.

**Dos modalidades /
Two types /
Deux modèles /
Zwei Typen**

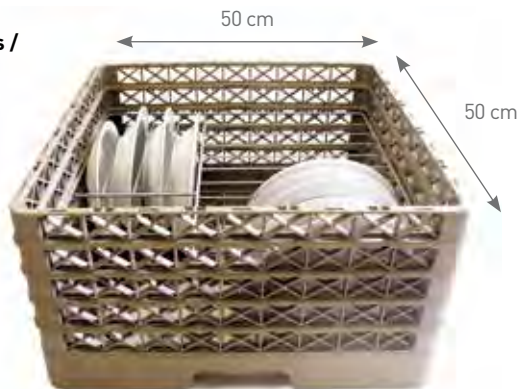

Limpieza y secado rápido.
Faster wash and rinse.
Propreté et séchage plus rapide.
Schnelle Reinigung und Trocknung.



Almacenamiento y transporte más seguro e higiénico.
More safety and hygienic storing and transporting.
Stockage et transport plus sûr et hygiénique.
Lagerung und Transport sicherer und hygienischer.

**Nueve formatos de rejilla /
Nine different grids /
Neuf grilles différentes /
Neun Gitterformate**

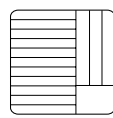

P1412-6

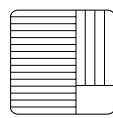

P1912-6

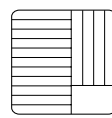

P1510-5

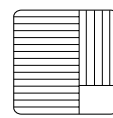

P2011-5

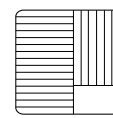

P2110-5

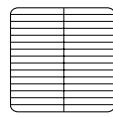

P3008-4

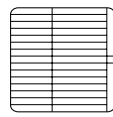

P3208-3

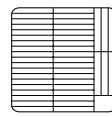

P4407-3

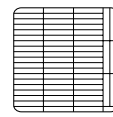

P6305-2

Mayor protección, resistencia y durabilidad.
Extra protection, strength and durability.
Plus grande protection, résistance et durabilité.
Extra Schutz, Resistenz und Langlebigkeit.

Como elegir la cesta de platos adecuada:
debe medir el diámetro y altura del plato. Con estos datos escoger, de las 9 combinaciones posibles, aquella que se ajuste más a las medidas del plato.

How to chose the appropriate plate crate:
measure the plate diameter and height. You have then to chose between the 9 different grids according to the measures you get previously.

Comment choisir le casier pour assiettes:
Mesurer le diamètre et l'hauteur de l'assiette. Selon ces mesures choisir entre le 9 possibles combinaisons de grille qui s'adapte au mieux.

Wie wählen Sie den geeigneten Tellerspülkorb:
Messen Sie den Diameter und die Höhe des Tellers. Mit diesen Massen wählen Sie eine von 9 verschiedenen Kombinationen aus, die sich am nächsten an die Masse der Teller anpasst.



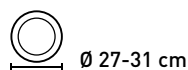

P1412-6

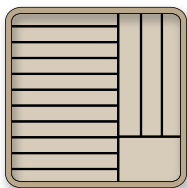

**FLAP
RACK®**



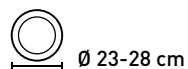

REF	 max. (cm)	CAPACIDAD PLATOS CAPACITY PLATES CAPACITÉ ASSIETTES TELLERFASSUNGSVERMÖGEN	
P1412-6	3,5	14	1
P1412-6 F1*	3,5	14	1

P1510-5

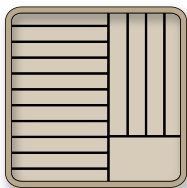

**FLAP
RACK®**



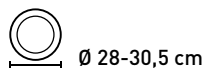

REF	 max. (cm)	CAPACIDAD PLATOS CAPACITY PLATES CAPACITÉ ASSIETTES TELLERFASSUNGSVER- MÖGEN	
P1510-5	3,5	15	1
P1510-5 F1*	3,5	15	1

P1912-6

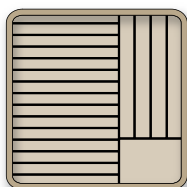

**FLAP
RACK®**



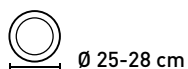

REF	 max. (cm)	CAPACIDAD PLATOS CAPACITY PLATES CAPACITÉ ASSIETTES TELLERFASSUNGSVERMÖGEN	
P1912-6	2,5	19	1
P1912-6 F1*	2,5	19	1

P2011-5

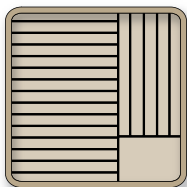

**FLAP
RACK®**



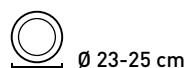

REF	 max. (cm)	CAPACIDAD PLATOS CAPACITY PLATES CAPACITÉ ASSIETTES TELLERFASSUNGSVERMÖGEN	
P2011-5	2,5	20	1
P2011-5 F1*	2,5	20	1

P2110-5

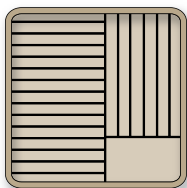

**FLAP
RACK®**



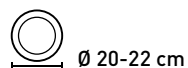

REF	 max. (cm)	CAPACIDAD PLATOS CAPACITY PLATES CAPACITÉ ASSIETTES TELLERFASSUNGSVERMÖGEN	
P2110-5	2,5	21	1
P2110-5 F1*	2,5	21	1

P3008-4

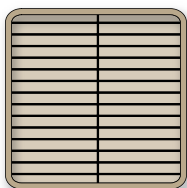

**FLAP
RACK®**



REF	 max. (cm)	CAPACIDAD PLATOS CAPACITY PLATES CAPACITÉ ASSIETTES TELLERFASSUNGSVERMÖGEN	
P3008-4	2,5	30	1
P3008-4 F1*	2,5	30	1

- * Cestas cerradas
- * Closed racks
- * Paniers fermés
- * Geschlossene Spülkörbe

Indicar el código de color al final de la referencia.
Indicate the colour code at the end of the item reference.
Indiquer le code de couleur a la fin de la référence.
Angabe des Farbcodes am Ende der Artikelnummer.

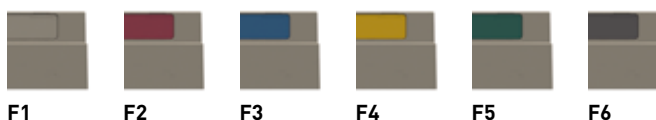

**FLAP
RACK®**

P3208-3

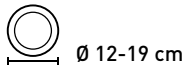

FLAP RACK®

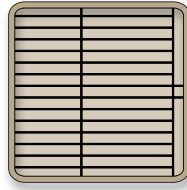

REF	I max. (cm)	CAPACIDAD PLATOS CAPACITY PLATES CAPACITÉ ASSIETTES TELLERFASSUNGSVERMÖGEN	
P3208-3	2,5	32	1
P3208-3 F1*	2,5	32	1

P4407-3

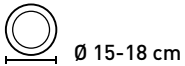

FLAP RACK®

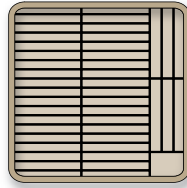

REF	I max. (cm)	CAPACIDAD PLATOS CAPACITY PLATES CAPACITÉ ASSIETTES TELLERFASSUNGSVERMÖGEN	
P4407-3	2	44	1
P4407-3 F1*	2	44	1

P6305-2

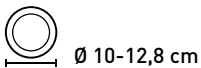

FLAP RACK®

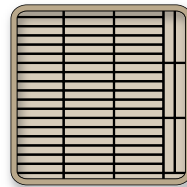

REF	I max. (cm)	CAPACIDAD PLATOS CAPACITY PLATES CAPACITÉ ASSIETTES TELLERFASSUNGSVERMÖGEN	
P6305-2	2,5	63	1
P6305-2 F1*	2,5	63	1

TR23 / TR30

Cesta para grandes bandejas / Open tray rack / Panier pour grands plateaux / Spülkorb für grosse tablett.



T-VERSION



TR23

TR30

REF	H cm NTERIOR / INSIDE / INTÉRIEURE / BESCHREIBUNG	H cm EXTERIOR / OUTSIDE / EXTÉRIEURE / AUSSENDURCH	
TR23*	13,3	13,3	1
TR30	8,3	10,2	1

* Capacidad para tres bandejas extendidas de tamaño completo.
Holds three full-size sheet pans.
Contient trois tôles à biscuits.
Fasst drei Backbleche in Standardgröße.

TR21 / TR22

Cesta para bandejas isotérmicas, GN y platos / GN, isothermal trays and plates rack / Panier pour plateaux isothermes, GN et assiettes / Spülkorb für isothermische tablett, GN und teller



T-VERSION



TR21

TR22

REF	H cm NTERIOR / INSIDE / INTÉRIEURE / BESCHREIBUNG	H cm EXTERIOR / OUTSIDE / EXTÉRIEURE / AUSSENDURCH	
TR21	8,3	12,1	1
TR22	13,3	13,3	1

TR21

8

Compartimentos.
Compartments.
Compartiments.
Fächer.

80 mm

Distancia entre compart.
Distance between compart.
Distance entre compart.
Fächerabstand.

TR22

5

Compartimentos / Compartments /
Compartiments / Fächer
Cesta de extremo abierto / Open end rack /
Casier ouvert à l'extrémité / Offener Korb

75 mm

Distancia entre compart. /
Distance between compart. /
Distance entre compart /
Fächerabstand

- * Cestas cerradas
- * Closed racks
- * Paniers fermés
- * Geschlossene Spülkörbe

Indicar el código de color al final de la referencia.
Indicate the colour code at the end of the item reference.
Indiquer le code de couleur a la fin de la référence.
Angabe des Farbcodes am Ende der Artikelnummer.



F1



F2



F3



F4



F5



F6

FLAP RACK®

6.4 CESTAS PARA VAJILLA / DISHWASHER RACKS / CASIERS À VAISSELLE / SPÜLMASCHINENKÖRBE

Signature

SISTEMAS PARA LAVAR UTENSILIOS / WAREWASHING RACKS / ARTICLES DE LAVAGE / GESCHIRRWÄSCHE

El diseño de esquinas con clavijas permite apilar de forma segura.
Peg corner design provides secure stacking.

Le concept a pointes aux angles permet un empilage sûr.
Stiftecken-Design gewährleistet ein sicheres Stapeln



El exclusivo diseño de cesta usa tornillos de acero inoxidable y una amplia variedad de montantes y divisores intercambiables para cientos de configuraciones personalizadas.

Unique rack design uses stainless screws and a variety of interchangeable risers and dividers for hundreds of custom configurations.

Le concept de casier unique utilise des vis inox et toute une variété de montants et partitions interchangeables pour des centaines de configurations sur mesure.

Einmaliges Regaldesign basiert auf Edelstahlschrauben und einer Vielfalt an austauschbaren Standern und Trenneinsätzen für Hunderte von Spezialkonfigurationen.

El diseño abierto facilita una mejor acción de lavado, enjuague y agiliza el secado.

Open design promotes better washing and rinsing, and faster drying.

La conception ouverte des casiers stimule l'action de lavage et produit un rinçage complet et un séchage plus rapide.

Offenes Design für ein wirkungsvolleres Waschen und Spülen und ein schnelleres Trocknen.

Durchgehende Bodenteilung schützt den Glasrand vor Beschädigungen. Für eine Vielfalt von Martini- und Margarita-Gläsern entworfen.



BASE
500 x 500 mm
h 71 mm



El divisor sólido en el fondo protege el borde de las copas contra picaduras. Diseñadas para una variedad de copas de martini y margarita.

Solid bottom divider protects the rim of the glasses from chipping. Designed for a variety of martini and margarita glasses.

Le fond plein empêche le bord des verres de s'ébrécher. Conçu pour une variété de verres à martini et à margarita.

COLORES / COLOURS / COULEURS / FARBEN

52720 7 7 5

3 colours
A

A

B C D
E D

A 16 COMP. 21,6 cm
B BASE
C Extensiones / Risers / Réhausses / Vergrößerungen
D Extensión superior / Top riser / Réhausse supérieur / Einsatz (oben)
E Cuando B y C son un mismo color / When B and C are the same colour / Quand B et C sont la même couleur / Wenn B und C die gleiche Farbe haben

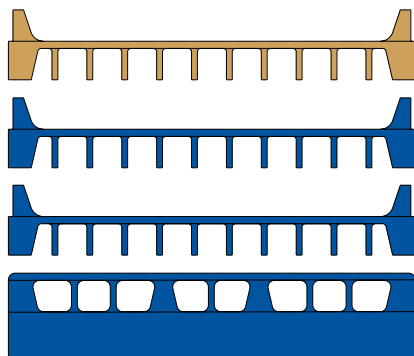





D	D	EXTENSIÓN SUPERIOR / TOP RISER / RÉHAUSSE SUPÉRIEUR / EINSATZ (OBEN)
C	E	EXTENSIONES / RISERS / RÉHAUSSES / VERGRÖßERUNGEN
B		BASE

1	3	5	6	7	9
Verde / Green Vert / Grün	Rojo / Red Rouge / Rot	Dorado / Gold Doré / Vergoldet	Gris / Grey Gris / Grau	Azul / Blue Bleu / Blau	Burdeos / Burgundy Bordeaux / Bordeauxrot

EXTENSIÓN SUPERIOR / TOP RISER / RÉHAUSSE SUPÉRIEUR / EINSATZ (OBEN)	D	D	✓	✓	✓	✓	✓	✓
EXTENSIONES / RISERS / RÉHAUSSES / VERGRÖSSERUNGEN	C	E	✓	✓	✓	✓	✓	✓
BASE	B	E	✓	✓	✓	✓	✓	✓

EJEMPLOS / EXAMPLES / EXEMPLES / BEISPIELE

	<p>52784 + 70</p> <p>Azul / Blue Bleu / Blau</p> <p>52784 <i>Signature</i> 49 COMP. 12,4 cm</p> <p>+</p> <p>7 BASE</p> <p>+</p> <p>0 SIN / WITHOUT / SANS / OHNE EXTENSIONES / EXTENSIONS / RÉHAUSSES / VERGRÖSSERUNGEN</p>
	<p>52812 + 77</p> <p>Azul / Blue Bleu / Blau</p> <p>52812 <i>Signature</i> 30 COMP. 14,3 cm</p> <p>+</p> <p>7 BASE</p> <p>+</p> <p>7 EXTENSIÓN SUPERIOR / TOP RISER / RÉHAUSSE SUPÉRIEUR / EINSATZ (OBEN)</p>
	<p>52757 + 63</p> <p>Gris / Grey Gris / Grau</p> <p>52757 <i>Signature</i> 20 COMP. 32,4 cm</p> <p>+</p> <p>6 BASE EXTENSIONES / EXTENSIONS / RÉHAUSSES / VERGRÖSSERUNGEN</p> <p>+</p> <p>3 EXTENSIÓN SUPERIOR / TOP RISER / RÉHAUSSE SUPÉRIEUR / EINSATZ (OBEN)</p>
	<p>52757 + 766</p> <p>Azul / Blue Bleu / Blau</p> <p>52757 <i>Signature</i> 20 COMP. 32,4 cm</p> <p>+</p> <p>7 BASE</p> <p>+</p> <p>6 EXTENSIONES / EXTENSIONS / RÉHAUSSES / VERGRÖSSERUNGEN</p> <p>+</p> <p>6 EXTENSIÓN SUPERIOR / TOP RISER / RÉHAUSSE SUPÉRIEUR / EINSATZ (OBEN)</p>
	<p>52757 + 763</p> <p>Azul / Blue Bleu / Blau</p> <p>52757 <i>Signature</i> 20 COMP. 32,4 cm</p> <p>+</p> <p>7 BASE</p> <p>+</p> <p>6 EXTENSIONES / EXTENSIONS / RÉHAUSSES / VERGRÖSSERUNGEN</p> <p>+</p> <p>3 EXTENSIÓN SUPERIOR / TOP RISER / RÉHAUSSE SUPÉRIEUR / EINSATZ (OBEN)</p>

CESTAS VAJILLA / DISHWASHER RACKS / CASIERS VAISSELLE

6.4 CESTAS PARA VAJILLA / DISHWASHER RACKS / CASIERS À VAISSELLE / SPÜLMASCHINENKÖRBE

Signature



EN CESTAS DE 20 Y 30 COMPARTIMIENTOS /
DESIGN ON THE 20 AND 30 COMPARTMENT RACKS /
SUR LES CASIERS À 20 ET 30 COMPARTIMENTS /
DESIGN BEI SPÜLKÖRBE MIT 20 UND 30 FÄCHERN



Los carriles de cuatro direcciones

en todas las cestas de tamaño completo permiten cargar rápidamente la máquina de platos en cualquier dirección.

Four-way tracking

on all full-size racks allows fast dish machine loading in either direction.

Les rails dans quatre sens

sur tous les casiers grande taille permettent un chargement rapide dans le lave-vaisselle sans se préoccuper du sens.

Sicheres Aufeinanderstellen auf allen vier Seiten

bei allen Körben in Standardgröße ermöglicht ein schnelles Laden der Geschirrspülmaschine in beiden Richtungen.

COLORES / COLOURS / COULEURS / FARBEN

Indicar el código de color al final de la referencia
Indicate the colour code at the end of the item reference
Indiquer le code de couleur a la fin de la référence
Angabe des Farbcodes am Ende der Artikelnummer

	1	3	5	6	7	9
D	✓	✓	✓	✓	✓	✓
C	✓	✓	✓	✓	✓	✓
B	✓	✓	✓	✓	✓	✓

Signature



Ø max. 149 mm

9 COMPART.

5276377



REF	1-2 COLORS	2-3 COLORS	EXT	H cm	Δ _{max.} (cm)	☐
52726	+B+0	-	BASE	10,5	7,1	6
52760	+B+0	-	BASE	12,4	8,3	5
52727	+E+D	+B+C+D	1	14,3	11,0	4
52761	+E+D	+B+C+D	1	16,2	12,2	4
52728	+E+D	+B+C+D	2	17,8	14,4	3
52762	+E+D	+B+C+D	2	19,7	15,9	3
52730	+E+D	+B+C+D	3	21,6	18,1	3
52763	+E+D	+B+C+D	3	23,5	19,5	2
52729	+E+D	+B+C+D	4	25,1	21,6	2
52764	+E+D	+B+C+D	4	26,8	23,0	2
52731	+E+D	+B+C+D	5	28,7	25,2	2
52765	+E+D	+B+C+D	5	30,8	26,8	2
52736	+E+D	+B+C+D	6	32,4	28,9	2

Signature



Ø max. 111 mm

16 COMPART.

5272077



REF	1-2 COLORS	2-3 COLORS	EXT	H cm	Δ _{max.} (cm)	☐
52694	+B+0	-	BASE	10,5	7,1	6
52766	+B+0	-	BASE	12,4	8,3	5
52718	+E+D	+B+C+D	1	14,3	11,0	4
52767	+E+D	+B+C+D	1	16,2	12,2	4
52719	+E+D	+B+C+D	2	17,8	14,4	3
52768	+E+D	+B+C+D	2	19,7	15,9	3
52720	+E+D	+B+C+D	3	21,6	18,1	3
52769	+E+D	+B+C+D	3	23,5	19,5	2
52721	+E+D	+B+C+D	4	25,1	21,6	2
52770	+E+D	+B+C+D	4	26,8	23,0	2
52732	+E+D	+B+C+D	5	28,7	25,2	2
52771	+E+D	+B+C+D	5	30,8	26,8	2
52737	+E+D	+B+C+D	6	32,4	28,9	2

Signature



Ø max. 100 mm

20 COMPART.

5275773



REF	1-2 COLORS	2-3 COLORS	EXT	H cm	Δ _{max.} (cm)	☐
52691	+B+0	-	BASE	10,5	7,1	6
52692	+B+0	-	BASE	12,4	8,3	5
52693	+E+D	+B+C+D	1	14,3	11,0	4
52702	+E+D	+B+C+D	1	16,2	12,2	4
52703	+E+D	+B+C+D	2	17,8	14,4	3
52704	+E+D	+B+C+D	2	19,7	15,9	3
52706	+E+D	+B+C+D	3	21,6	18,1	3
52707	+E+D	+B+C+D	3	23,5	19,5	2
52708	+E+D	+B+C+D	4	25,1	21,6	2
52709	+E+D	+B+C+D	4	26,8	23,0	2
52754	+E+D	+B+C+D	5	28,7	25,2	2
52755	+E+D	+B+C+D	5	30,8	26,8	2
52757	+E+D	+B+C+D	6	32,4	28,9	2

COLORES / COLOURS / COULEURS / FARBEN

Indicar el código de color al final de la referencia
Indicate the colour code at the end of the item reference
Indiquer le code de couleur a la fin de la référence
Angabe des Farbcodes am Ende der Artikelnummer

		1	3	5	6	7	9
D	D	✓	✓	✓	✓	✓	
C	E	✓	✓	✓	✓	✓	
B		✓		✓	✓	✓	✓

Signature NSF

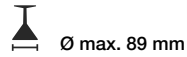

25 COMPART.

5271177



REF	1-2 COLORS	2-3 COLORS	EXT	H cm	▲I _{max.} (cm)	☐
52684	+B+0	-	BASE	10,5	7,1	6
52772	+B+0	-	BASE	12,4	8,3	5
52710	+E+D	+B+C+D	1	14,3	11,0	4
52773	+E+D	+B+C+D	1	16,2	12,2	4
52711	+E+D	+B+C+D	2	17,8	14,4	3
52774	+E+D	+B+C+D	2	19,7	15,9	3
52712	+E+D	+B+C+D	3	21,6	18,1	3
52775	+E+D	+B+C+D	3	23,5	19,5	2
52713	+E+D	+B+C+D	4	25,1	21,6	2
52776	+E+D	+B+C+D	4	26,8	23,0	2
52733	+E+D	+B+C+D	5	28,7	25,2	2
52777	+E+D	+B+C+D	5	30,8	26,8	2
52738	+E+D	+B+C+D	6	32,4	28,9	2

Signature NSF

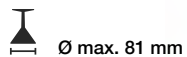

30 COMPART.

5281277



REF	1-2 COLORS	2-3 COLORS	EXT	H cm	▲I _{max.} (cm)	☐
52790	+B+0	-	BASE	10,5	7,1	6
52811	+B+0	-	BASE	12,4	8,3	5
52812	+E+D	+B+C+D	1	14,3	11,0	4
52813	+E+D	+B+C+D	1	16,2	12,2	4
52816	+E+D	+B+C+D	2	17,8	14,4	3
52817	+E+D	+B+C+D	2	19,7	15,9	3
52832	+E+D	+B+C+D	3	21,6	18,1	3
52844	+E+D	+B+C+D	3	23,5	19,5	2
52845	+E+D	+B+C+D	4	25,1	21,6	2
52846	+E+D	+B+C+D	4	26,8	23,0	2
52847	+E+D	+B+C+D	5	28,7	25,2	2
52848	+E+D	+B+C+D	5	30,8	26,8	2
52849	+E+D	+B+C+D	6	32,4	28,9	2

Signature NSF

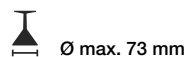

36 COMPART.

5271577



REF	1-2 COLORS	2-3 COLORS	EXT	H cm	▲I _{max.} (cm)	☐
52689	+B+0	-	BASE	10,5	7,1	6
52778	+B+0	-	BASE	12,4	8,3	5
52714	+E+D	+B+C+D	1	14,3	11,0	4
52779	+E+D	+B+C+D	1	16,2	12,2	4
52715	+E+D	+B+C+D	2	17,8	14,4	3
52780	+E+D	+B+C+D	2	19,7	15,9	3
52716	+E+D	+B+C+D	3	21,6	18,1	3
52781	+E+D	+B+C+D	3	23,5	19,5	2
52717	+E+D	+B+C+D	4	25,1	21,6	2
52782	+E+D	+B+C+D	4	26,8	23,0	2
52734	+E+D	+B+C+D	5	28,7	25,2	2
52783	+E+D	+B+C+D	5	30,8	26,8	2
52739	+E+D	+B+C+D	6	32,4	28,9	2

Signature NSF

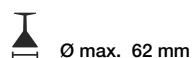

49 COMPART.

5278470



REF	1-2 COLORS	2-3 COLORS	EXT	H cm	▲I _{max.} (cm)	☐
52699	+B+0	-	BASE	10,5	7,1	6
52784	+B+0	-	BASE	12,4	8,3	5
52722	+E+D	+B+C+D	1	14,3	11,0	4
52785	+E+D	+B+C+D	1	16,2	12,2	4
52723	+E+D	+B+C+D	2	17,8	14,4	3
52786	+E+D	+B+C+D	2	19,7	15,9	3
52724	+E+D	+B+C+D	3	21,6	18,1	3
52787	+E+D	+B+C+D	3	23,5	19,5	2
52725	+E+D	+B+C+D	4	25,1	21,6	2
52788	+E+D	+B+C+D	4	26,8	23,0	2
52735	+E+D	+B+C+D	5	28,7	25,2	2
52789	+E+D	+B+C+D	5	30,8	26,8	2
52740	+E+D	+B+C+D	6	32,4	28,9	2

CESTAS VAJILLA / DISHWASHER RACKS / CASIERS VAISSELLE

COLORES / COLOURS / COULEURS / FARBEN

Indicar el código de color al final de la referencia
 Indicate the colour code at the end of the item reference
 Indiquer le code de couleur a la fin de la référence
 Angabe des Farbcodes am Ende der Artikelnummer

		1	3	5	6	7	9
D	D	✓	✓	✓	✓	✓	
C	E	✓	✓	✓	✓	✓	
B		✓		✓	✓	✓	✓

52670 Cesta universal / Open rack / Panier universel / Universalspülkorb

Signature



5268077



REF	1-2 COLORS	2-3 COLORS	EXT	H cm	max. (cm)	
52670	+ B + 0	-	BASE	10,5	7,1	6
52696	+ B + 0	-	BASE	12,4	8,3	5
52680	+ E + D	+ B + C + D	1	14,0	10,5	4
52681	+ E + D	+ B + C + D	1	17,5	14,0	3
52682	+ E + D	+ B + C + D	2	20,8	17,3	3
52683	+ E + D	+ B + C + D	2	24,3	21,0	2

52695 Cesta para platos / Plate racks / Casiers assiettes / Tellerspülkörbe

Signature



5269570



REF	1-2 COLORS	EXT	H cm	
52695	+ B + 0	BASE	12,4	5
52672	+ B + 0	BASE	9,5	6

52671 Cesta para cubiertos / Cutlery baskets / Panier pour couverts / Körbe für Besteck

Signature



5267170



REF	1-2 COLORS	EXT	H cm	
52671	+ B + 0	BASE	10,5	6

**GUÍA DE SELECCIÓN PARA BASES Y EXTENSIONES /
REFERENCE GUIDE FOR BASES AND EXTENSIONS /
GUIDE DE SELECTION POUR BASES ET EXTENTIONS /
AUSWAHLÜBERSICHT FÜR DIE BASIS UND VERGRÖSSERUNGEN**

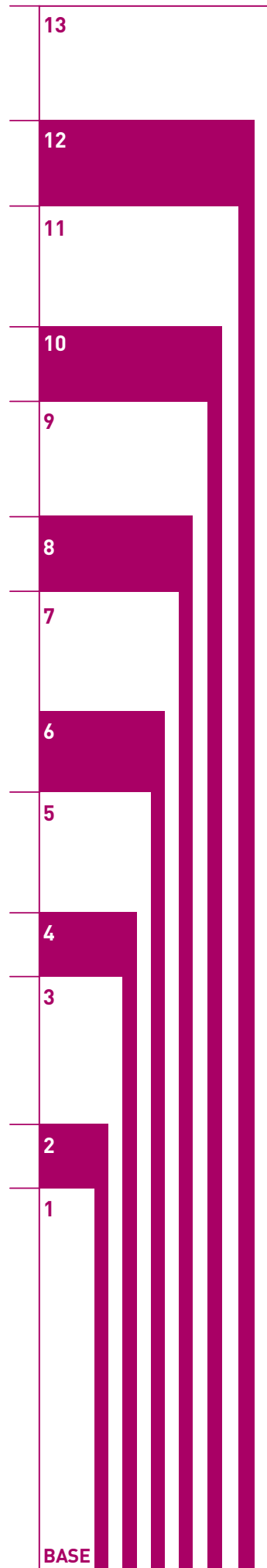

CESTAS VAJILLA /
DISHWASHER RACKS /
CASIERS VAISSELLE

	cm		cm
1 SHORT	7,1	7 X-TALL	18,1
2 SHORT PLUS	8,3	8 X-TALL PLUS	19,5
3 MEDIUM	11,0	9 XX-TALL	21,6
4 MEDIUM PLUS	12,2	10 XX-TALL PLUS	23,0
5 TALL	14,4	11 XXX-TALL	25,2
6 TALL PLUS	15,9	12 XXX-TALL PLUS	26,8
		13 XXXX-TALL	28,9



GUÍA DE SELECCIÓN DE CESTAS PARA VAJILLA / DISHWASHER RACKS SELECTION GUIDE /
GUIDE DE SÉLECTION CASIERS À VAISSELLE / AUSWAHLÜBERSICHT SPÜLMASCHINENKÖRBE



**CARROS /
TROLLEYS /
CHARIOTS /
SERVIERWAGEN**

7.1	CARROS DE SERVICIO ALUMINIO / ALUMINIUM SERVING TROLLES / CHARIOTS DE SERVICE EN ALUMINIUM / SERVIERWAGEN AUS ALUMINIUM	200
7.2	CARROS DE SERVICIO ACERO INOXIDABLE / ST/STEEL SERVING TROLLEYS / CHARIOTS DE SERVICE EN ACIER INOXYDABLE / SERVIERWAGEN AUS EDELSTAHL	201
7.3	CARROS GUÍAS EN ACERO INOXIDABLE / ST/STEEL RAIL TROLLEYS / CHARIOTS À GLISSIÈRES EN ACIER INOXYDABLE / SERVIERWAGEN MIT EINSCHÜBEN AUS EDELSTAHL	204
7.4	CARROS ESPECIALES / SPECIAL TROLLEYS / CHARIOTS SPÉCIAUX / SPEZIALWAGEN	210

P8090 Carro aluminio desembarace / Aluminium clearing trolley /
Chariot débarrassage en aluminium / Aluminium Abräumwagen

EXCLUSIVE



REF	
P80.900	1

Medidas de estantes adaptables a cubetas GN 1/1 y cestas FLAP-RACK® (500 x 500 mm). Carga máxima: total 150 Kg y con un máximo de 75 Kg por estante.

Racks adjustable to 1/1 GN containers and FLAP-RACK® (500 x 500 mm). Maximum load: 150 Kg and max. per level 75 Kg.

Clayettes adaptables à des bacs GN 1/1 et à casiers à vaisselle FLAP-RACK® (500 x 500 mm). Charge maximale: total 150 Kg et 75 Kg par niveau.

Masse der regale passend für GN behälter 1/1 und FLAP-RACK® spülkörbe (500 x 500 mm). Maximale tragkraft: total 150 Kg und maximal 75 Kg pro regal.

P6411 Carro de servicio / Trolley / Chariot de service / Servierwagen

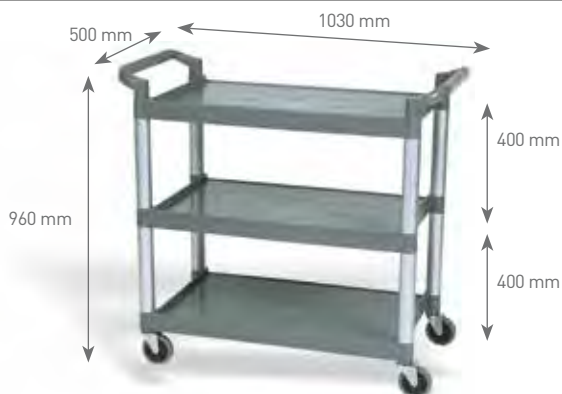

REF	DIM. ESTANTE / SHELF DIMENTION / DIM. NIVEAU / REGALGRÖSSE mm	
P641.100	780 x 485	1

Carga máxima 120 kgs
Maximum weight load 120 kgs
Charge maximale 120 kgs
Maximale Tragkraft 120 kg

Soportes de aluminio
Aluminium supports
Supports en aluminium
Aluminiumständer

P642 / P643 Contenedor para cubiertos / Silverware container / Conteneur pour couverts / Besteckkasten
Contenedor para desperdicios / Refuse container / Conteneur pour déchets / Abfalleimer



REF	cm	Lts	
P642.000	32 x 19,5 x 16,5	9,00	1
P643.000	33,5 x 23 x 56	80,00	1

P640 Conjunto carro / Set trolley / Ensemble chariot / Servierwagenset



REF	DIM. ESTANTE / SHELF DIMENTION / DIM. NIVEAU / REGALGRÖSSE mm	
P640.000	780 x 485	1

ESTRUCTURA TUBULAR EN ACERO INOX DE 1.5 MM ESPESOR /
1.5 MM THICK ST/STEEL TUBULAR FRAME /
STRUCTURE TUBULAIRE EN ACIER INOXYDABLE 1.5 MM. EPAISSEUR /
STRUKTUR AUS EDELSATHLROHR VON 1,5 MM DICKE.



CARGA MÁXIMA TOTAL 250 KG. CARGA MÁXIMA POR ESTANTE 80 KG /
TOTAL MAXIMUM LOAD 250 KG. MAX. LOAD PER LEVEL 80 KG /
CHARGE MAXIMALE TOTAL 250 KG. CHARGE MAXIMALE PER NIVEAU 80 KG /
MAXIMALE TRAGKRAFT: TOTAL 250 KG UND MAX 80 KG PRO REGAL.

RUEDAS GIRATORIAS DE 12 CM DIÁMETRO. DOS CON FRENOS /
12 CM DIAM. REVOLVING CASTERS. TWO WITH BRAKES /
ROUES GIRATOIRES DE 12 CM DIAM. DEUX AVEC FREINS /
DREHBARE RÄDER 12 CM DURCHMESSER. ZWEI MIT BREMSVORRICHTUNG



P8024 Carro servicio acero inox / St/steel serving trolley /
Chariot service en acier inox / Servierwagen Edelstahl

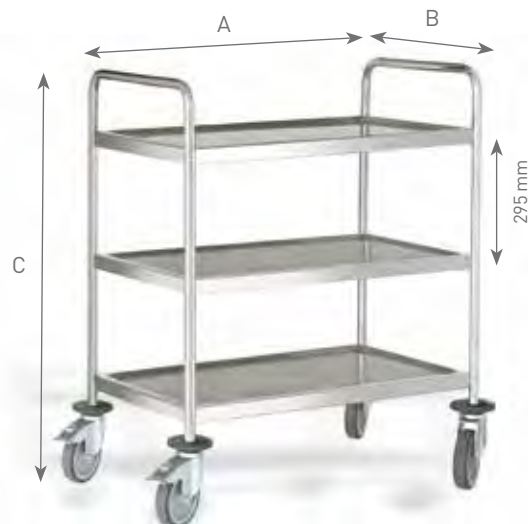

REF	ESTANTES / LEVELS / NIVEAUX / REGALE	DIM. ESTANTE / SHELF DIMENTION / DIM. NIVEAU / REGALGRÖSSE mm	A x B x C mm	
P80.240	2	800 x 500	880 x 580 x 1015	1
P80.250	2	900 x 500	980 x 580 x 1015	1
P80.260*	2	1000 x 600	1080 x 680 x 1015	1
P80.270	3	800 x 500	880 x 580 x 1015	1
P80.280	3	900 x 500	980 x 580 x 1015	1
P80.290*	3	1000 x 600	1080 x 680 x 1015	1
P80.300	4	800 x 500	880 x 580 x 1300	1
P80.310	4	900 x 500	980 x 580 x 1300	1
P80.320*	4	1000 x 600	1080 x 680 x 1300	1

*Estantes de chapa de mayor espesor / Thicker shelves /
Plateaux plus épais / Regal aus dickerem Blech.

Disponible también con ruedas poliamida. Consultar precio.
Available also on polyamide castors. Please ask for price.
Disponible aussi avec roulettes polyamide. Consulter prix.
Auch lieferbar mit Polyamidrädern. Bitte Preis nachfragen.





MONTAJE /
ASSEMBLY /
MONTAGE /
MONTAGE



SE ENTREGAN DESMONTADOS. MUY ROBUSTOS Y SÓLIDOS /
DELIVERED FLATPACKED. VERY STRONG AND RESISTANT ONCE ASSEMBLED /
LIVRÉS DÉMONTÉS. TRÈS ROBUSTES ET SOLIDES UNE FOIS MONTÉS /
LIEFERUNG UNMONTIERT. EINMAL MONTIERT SIND SIE SEHR ROBUST UND SOLIDE

CARGA MÁXIMA TOTAL 250 KG. CARGA MÁXIMA POR ESTANTE 80 KG /
TOTAL MAXIMUM LOAD 250 KG. MAX. LOAD PER LEVEL 80 KG /
CHARGE MAXIMALE TOTAL 250 KG. CHARGE MAXIMALE PER NIVEAU 80 KG /
MAXIMALE TRÄGKRAFT: TOTAL 250 KG UND MAX 80 KG PRO REGAL

RUEDAS GIRATORIAS DE 12 CM DIÁMETRO. DOS CON FRENOS /
12 CM DIAM. REVOLVING CASTERS. TWO WITH BRAKES
ROUES GIRATOIRES DE 12 CM DIAM. DEUX AVEC FREINS /
DREHBARE RÄDER 12 CM DURCHMESSER. ZWEI MIT BREMSVORRICHTUNG



P8033 Carro desmontable / Disassembled trolley / Chariot démontable / Demontierbarer Servierwagen

REF	ESTANTES / LEVELS / NIVEAUX / REGALE	DIM. ESTANTE / SHELF DIMENTION / DIM. NIVEAU / REGALGRÖSSE mm	A x B x C mm	
P80.330	2	800 x 500	810 x 545 x 1040	1
P80.340	2	900 x 500	910 x 545 x 1040	1
P80.350	3	800 x 500	810 x 545 x 1040	1
P80.360	3	900 x 500	910 x 545 x 1040	1

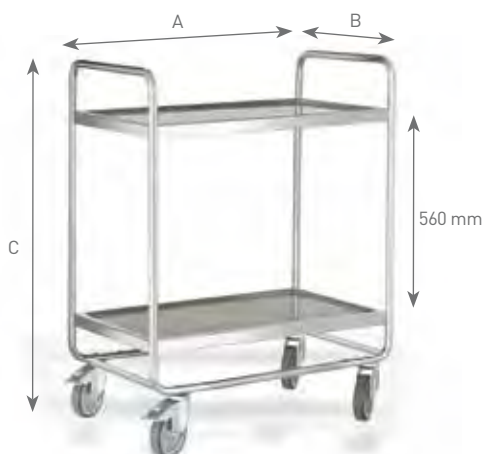

P8096 Carro desmontable ligero / Light disassembled trolley / Chariot démontable légère / Leichter demontierbarer Servierwagen

Ruedas acero Ø 100 mm. Dos con freno.
Castors Ø 100 mm. Two with brakes.
Roulettes Ø 100 mm. Deux avec freins.
Edelstahlräder Ø 100 mm. Zwei mit Bremsen.

REF	ESTANTES / LEVELS / NIVEAUX / REGALE	DIM. ESTANTE / SHELF DIMENTION / DIM. NIVEAU / REGALGRÖSSE mm	
P80.960	2	830 x 510	1
P80.961	3	830 x 510	1

GAMA ECONÓMICA /
ECONOMIC LINE /
GAMME ECONOMIQUE /
ÖKONOMISCHE SERIE



CARROS DE SERVICIO SOLDADOS / WELDED SERVING TROLLEYS /
CHARIOTS DE SERVICE SOUDÉS / GESCHWEISSTE SERVIERWAGEN

P8094 Carro servicio con barandilla / Serving trolley with guard-rail shelf /
Chariot service avec galerie / Servierwagen mit Geländer



REF	ESTANTES / LEVELS / NIVEAUX / REGALE	DIM. ESTANTE / SHELF DIMENTION / DIM. NIVEAU / REGALGRÖSSE mm	
P80.940	2	800 x 500	1
P80.941	3	800 x 500	1

Disponibile también con ruedas poliamida. Consultar precio /
Available also on polyamide castors. Please ask for price /
Disponibile aussi avec roulettes polyamide. Consulter prix /
Auch lieferbar mit Polyamidrädern. Bitte Preis nachfragen.

P8068 Carro desembarace inox / St/Steel clearing trolley /
Chariot de débarrassage en inox / Abräumwagen



REF	ESTANTES / LEVELS / NIVEAUX / REGALE	DIM. ESTANTE / SHELF DIMENTION / DIM. NIVEAU / REGALGRÖSSE mm	
P80.680	2	1.000 x 600	1

Disponibile también con ruedas poliamida. Consultar precio.
Available also on polyamide castors. Please ask for price.
Disponibile aussi avec roulettes polyamide. Consulter prix.
Auch lieferbar mit Polyamidrädern. Bitte Preis nachfragen.

No incluye cubeta Gastronorm 1/2.
1/2 Gastronorm container not included.
Bac Gastronorme 1/2 non inclus.
1/2 Gastronorm Behälter nicht im Preis inklusive.

Ø 165 mm

Cubertero para carro servicio /
Cutlery dispenser for serving trolley /
Ramasse-couverts pour chariot service /
Behälter für Servicewagen

P80374



REF	Mod	H mm	
P80.374	GN 1/3	150	1

VER PRODUCTOS EN / SEE PRODUCTS ON /
VOIR PRODUITS EN PAGE / SIEHE PRODUKTE IN

CARRO MADERA PRESENTACIÓN BUFFET /
WOODEN BUFFET SERVING TROLLEY /
CHARIOT BUFFET EN BOIS PRÉS. BUFFET /
BUFFETSERVIERWAGEN AUS HOLZ



P. 444

P8043 Carro 17 guías GN 1/1 / 17 rails trolley for 1/1 GN pans /
Chariot 17 glissières pour bacs GN 1/1 / Servierwagen mit 17 Einschüben für GN 1/1



REF	
P80.430	1

Entrada 325 mm
Entrance 325 mm
Entrée 325 mm
Eingang 325 mm

Disponible también con ruedas poliamida. Consultar precio.
Available also on polyamide castors. Please ask for price.
Disponible aussi avec roulettes polyamide. Consulter prix.
Auch lieferbar mit Polyamidrädern. Bitte Preis nachfragen.

P8067 Carro doble 17 x 2 guías 1/1 / Double rail trolley 17 x 2 for 1/1 GN pans /
Chariot double 17 x 2 glissières pour bacs GN 1/1 / Doppelservierwagen mit 17 x 2 Einschüben für GN 1/1



REF	
P80.670	1

Entrada 325 mm
Entrance 325 mm
Entrée 325 mm
Eingang 325 mm

Disponible también con ruedas poliamida. Consultar precio.
Available also on polyamide castors. Please ask for price.
Disponible aussi avec roulettes polyamide. Consulter prix.
Auch lieferbar mit Polyamidrädern. Bitte Preis nachfragen.

VER PRODUCTOS EN / SEE PRODUCTS ON / VOIR PRODUITS EN PAGE / SIEHE PRODUKTE IN

BANDEJAS GN Y PASTELERÍA /
GN AND BAKING SHEET PANS /
PLAQUES GN ET PÂTISSERIE /
GN-TABLETTS UND BACKWAREN



P. 70, 72

P8052 Carro encastrable 17 guías GN 1/1 / Stackable trolley 17 rails for 1/1 GN pans /
Chariot emboîtable 17 glissières pour bacs GN 1/1 / Klappbarer Servierwagen mit 17 Einschüben für GN 1/1

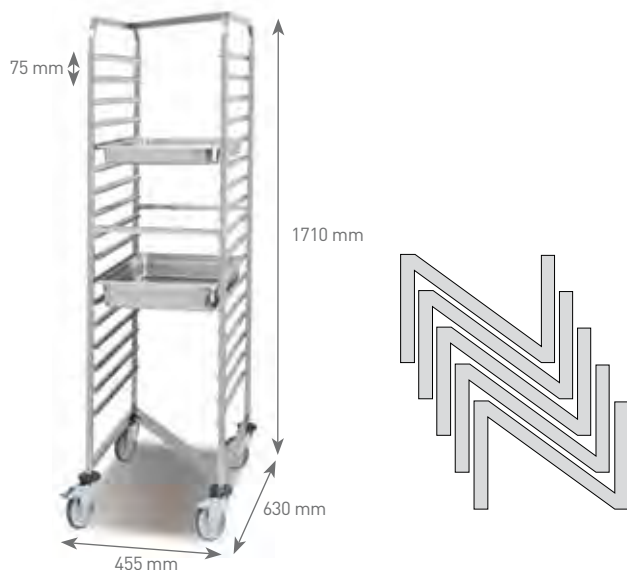

REF	
P80.520	1

Entrada 325 mm
Entrance 325 mm
Entrée 325 mm
Eingang 325 mm

Disponible también con ruedas poliamida. Consultar precio.
Available also on polyamide castors. Please ask for price.
Disponibile aussi avec roulettes polyamide. Consulter prix.
Auch lieferbar mit Polyamidrädern. Bitte Preis nachfragen.

P8047 Carro desmontable 17 guías GN 1/1 / Disassembled trolley 17 rails for 1/1 GN pans /
Chariot démontable 17 glissières pour bacs GN 1/1 / Demontierbarer Servierwagen mit 17 Einschüben für GN 1/1



REF	
P80.470	1

Entrada 325 mm
Entrance 325 mm
Entrée 325 mm
Eingang 325 mm

Disponible también con ruedas poliamida. Consultar precio.
Available also on polyamide castors. Please ask for price.
Disponibile aussi avec roulettes polyamide. Consulter prix.
Auch lieferbar mit Polyamidrädern. Bitte Preis nachfragen.

Desmontado /
Flat packed /
Livré démonté /
Demontiert

P8097 Carro desmontable ligero 15 guías GN 1/1 /
Light Disassembled trolley 15 rails for 1/1 GN pans /
Chariot démontable léger 15 glissières pour bacs GN 1/1 /
Leichter Demontierbarer Servierwagen mit 15 Einschüben für GN 1/1



REF	
P80.970	1

Entrada 325 mm
Entrance 325 mm
Entrée 325 mm
Eingang 325 mm

Ruedas acero Ø 120 mm. Dos con freno.
Castors Ø 120 mm. Two with brakes.
Roulettes Ø 120 mm. Deux avec freins.
Edelstahlrollen Ø 120 mm. Zwei mit Bremsen.

GAMA ECONÓMICA /
ECONOMIC LINE /
GAMME ECONOMIQUE /
ÖKONOMISCHE SERIE

P8044 Carro 17 guías GN 2/1 / 17 rails trolley for 2/1 GN pans /
Chariot 17 glissières pour bacs GN 2/1 / Servierwagen mit 17 Einschüben für GN 2/1



REF	
P80.440	1

Entrada 530 mm
Entrance 530 mm
Entrée 530 mm
Eingang 530 mm

Disponible también con ruedas poliamida. Consultar precio.
Available also on polyamide castors. Please ask for price.
Disponible aussi avec roulettes polyamide. Consulter prix.
Auch lieferbar mit Polyamidrädern. Bitte Preis nachfragen.

P8048 Carro desmontable 17 guías GN 2/1 / Disassembled trolley 17 rails for 2/1 GN pans /
Chariot démontable 17 glissières pour bacs GN 2/1 / Demontierbarer Servierwagen mit 17 Einschüben für GN 2/1



REF	
P80.480	1

Entrada 530 mm
Entrance 530 mm
Entrée 530 mm
Eingang 530 mm

Disponible también con ruedas poliamida. Consultar precio.
Available also on polyamide castors. Please ask for price.
Disponible aussi avec roulettes polyamide. Consulter prix.
Auch lieferbar mit Polyamidrädern. Bitte Preis nachfragen.

Desmontado /
Flat packed /
Livré démonté /
Demontiert

P8051 Carro encastrable 17 guías GN 2/1 / Stackable trolley 17 rails for 2/1 GN pans /
Chariot emboîtable 17 glissières pour bacs GN 2/1 / Klappbarer Servierwagen mit 17 Einschüben für GN 2/1

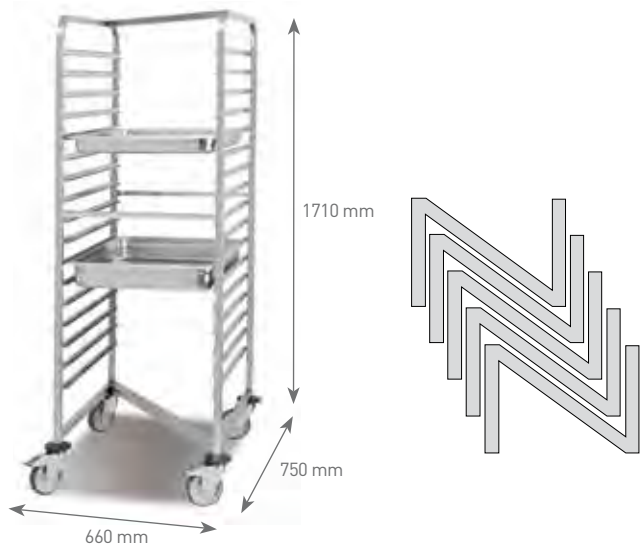

REF	
P80.510	1

Entrada 530 mm
Entrance 530 mm
Entrée 530 mm
Eingang 530 mm

Disponible también con ruedas poliamida. Consultar precio.
Available also on polyamide castors. Please ask for price.
Disponible aussi avec roulettes polyamide. Consulter prix.
Auch lieferbar mit Polyamidrädern. Bitte Preis nachfragen.

P8084 / P8085 / P8046 Carro pastelería / Pastry trolley / Chariot pâtisserie / Patisseriewagen



REF	MEDIDA GUÍAS / SIZE OF RAILS / DIMENSIONS GLISSIÈRES / EINSCHUBGRÖSSEN mm	Nº GUÍAS / NR. OF LEVELS / NUM. NIVEAUX / NR. EINSCHÜBE	DISTANCIA ENTRE GUÍAS / DISTANCE BETWEEN LEVELS / ESPACE ENTRE NIVEAUX / EINSCHUBABSTÄNDE mm	
P80.840	600 x 400	15	85	1
P80.850	600 x 400	20	70	1
P80.460	600 x 400	30	45	1

Entrada 400 mm
Entrance 400 mm
Entrée 400 mm
Eingang 400 mm

Disponible también con ruedas poliamida. Consultar precio.
Available also on polyamide castors. Please ask for price.
Disponibile aussi avec roulettes polyamide. Consulter prix.
Auch lieferbar mit Polyamidrädern. Bitte Preis nachfragen.

**Carro desmontable bandejas pastelería /
Disassembled rail trolley for bakery /
Chariots démontable pour plaques à pâtisserie /
Demontierbarer Wagen für Patisserietabletts**

P8087 / P8088 / P8050



REF	MEDIDA GUÍAS / SIZE OF RAILS / DIMENSIONS GLISSIÈRES / EINSCHUBGRÖSSEN mm	Nº GUÍAS / NR. OF LEVELS / NUM. NIVEAUX / NR. EINSCHÜBE	DISTANCIA ENTRE GUÍAS / DISTANCE BETWEEN LEVELS / ESPACE ENTRE NIVEAUX / EINSCHUBABSTÄNDE mm	
P80.870	600 x 400	15	85	1
P80.880	600 x 400	20	70	1
P80.500	600 x 400	30	45	1

Entrada 400 mm
Entrance 400 mm
Entrée 400 mm
Eingang 400 mm

Disponible también con ruedas poliamida. Consultar precio.
Available also on polyamide castors. Please ask for price.
Disponibile aussi avec roulettes polyamide. Consulter prix.
Auch lieferbar mit Polyamidrädern. Bitte Preis nachfragen.

Desmontado / Flat packed /
Livré démonté / Demontiert

P8053 Carro encastrable pastelería 15 guías / Stackable pastry trolley 15 rails /
Chariot emboîtable pâtisserie 15 glissières / Klappbarer Patisseriewagen 15 Einschübe

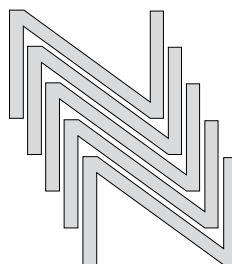

REF	
P80.530	1

Disponibile también con ruedas poliamida. Consultar precio.
Available also on polyamide castors. Please ask for price.
Disponibile aussi avec roulettes polyamide. Consulter prix.
Auch lieferbar mit Polyamidrädern. Bitte Preis nachfragen.

P8081 Carro descongelación 9 guías / Defrost trolley 9 rails /
Chariot à dégivrage 9 glissières / Auftauwagen mit 9 Einschüben

PATENTED EXCLUSIVE



REF	Mod	A x B x C mm	
P80.810	GN 2/1	665 x 755 x 1720	1
P80.813	GN 1/1	455 x 635 x 1720	1

Ahorro de espacio en el proceso de descongelado de los alimentos.
Space saver while foodstuff defrost.
Economie d'espace pendant le dégivrage des aliments.
Platzsparend im Auftauverfahren von Lebensmitteln.

Disponible también con ruedas poliamida. Consultar precio.
Available also on polyamide castors. Please ask for price.
Disponible aussi avec roulettes polyamide. Consulter prix.
Auch lieferbar mit Polyamidrädern. Bitte Preis nachfragen.

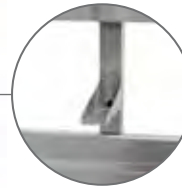

P80811 Cubeta especial GN para carro descongelación / Special GN container for defrost trolley /
Bac GN spécial pour chariot dégivrage / Spezial GN Behälter zum Auftauen



REF	Mod	mm	Lts	H mm	
P80.811	GN 2/1	650 x 530	28,90	100,0	1
P80.814	GN 1/1	530 x 325	14,20	100,0	1

Cubeta con desagüe.
Container with drainer hole.
Bac avec dégorgeement.
Behälter mit Abwasserloch.

P215 / P115 Fondo perforado para cubeta / Perforated bottom /
Egouttoir pour bac / Gelochter Einlegeboden für Behälter



REF	Mod	
P215.000 ¹	GN 2/1	1
P115.000 ²	GN 1/1	1

¹ Recomendado para ref. P80811
Recommended for item code P80811
Recommandé pour réf. P80811
Empfohlen für Art.Nr. P80811

² Recomendado para ref. P80814
Recommended for item code P80814
Recommandé pour réf. P80814
Empfohlen für Art.Nr. P80814

VER PRODUCTOS EN / SEE PRODUCTS ON / VOIR PRODUITS EN PAGE / SIEHE PRODUKTE IN

REJILLAS / GRIDS /
GRILLES / ROSTE

P. 74



P8095 Carro self-service 12 guías / Self-service trolley 12 rails /
Chariot self-service 12 glissières / Selbstbedienungswagen 12 Einschübe



REF		REF	
P80.950			1
P80.951*			1

Para bandejas de ancho 365 mm hasta 420 mm
For trays from 365 mm to 420 mm width
Pour plateaux de 365 mm à 420 mm
Für Tablettis der Breite von 365 mm bis 420 mm.

- * Con dos paneles laterales composite+aluminio.
- * With two side panels made of aluminium+composite .
- * Avec deux panneaux latéraux en composite+aluminium.
- * Mit zwei Seitenwänden aus composite+Aluminium.

P8091 Carro doble para bandejas fast-food 12 guías / Double fast-food tray trolley 12 rails /
Chariot double pour plateaux fast-food 12 glissières / Doppelwagen für Fast-Food Tablettis 12 Einschübe



REF	MEDIDA GUÍAS / SIZE OF RAILS / DIMENSIONS GLISSIÈRES / EINSCHÜBGRÖSSE mm		REF	
P80.910	480 x 800			1

Entrada 480 mm
Entrance 480 mm
Entrée 480 mm
Eingang 480 mm

Ideal para bandejas 480 x 370 mm
Suitable for trays 480 x 370 mm
Ideal pour plateaux 480 x 370 mm
Ideal für Tablettis 480 x 370 mm

Disponible también con ruedas poliamida. Consultar precio.
Available also on polyamide castors. Please ask for price.
Disponibile aussi avec roulettes polyamide. Consulter prix.
Auch lieferbar mit Polyamidrädern. Bitte Preis nachfragen.

P925 Carro transporte bandejas isotérmicas / Transport trolley for isothermal trays /
Chariot transport plateaux isothermes / Transportwagen für isothermische Tablettis



REF	MEDIDA GUÍAS / SIZE OF RAILS / DIMENSIONS GLISSIÈRES / EINSCHÜBGRÖSSEN mm	Nº GUÍAS / NR. OF LEVELS / NUM. NIVEAUX / NR. EINSCHÜBE		REF	
P925.001	550 x 375	10			1
P925.002	550 x 375	20			1

Carro fabricado en acero inoxidable y guías de plástico. Ideal para el transporte de bandejas de distintas medidas, gracias al diseño especial de sus guías. Ruedas giratorias insonoras de Ø 125 mm.

Chariot fabriqué en acier inoxydable et glissières en plastique. Idéal pour le transport des plateaux de différentes mesures, grâce au design spécial des glissières. Roulettes insonores de Ø 125 mm.

Trolley made of St/Steel and plastic rails. Perfect for many different size trays transport thanks to the special rail design. Soundproof revolving castors Ø 125 mm.

Wagen hergestellt aus rostfreiem Stahl mit Plastikeinschüben. Ideal für den Transport von Tablettis verschiedener Größen, dank seinem speziellen Design der Einschübe. Geräuschlose drehbare Räder Ø 125 mm.

P8039 Carro porta cubetas GN / GN containers transport trolley /
Chariot transport bacs GN / Transportwagen für GN Behälter



REF	
P80.390	1

No incluye cubetas GN.
GN containers not included.
Bacs GN non inclus.
GN Behälter nicht inklusive.

Disponible también con ruedas poliamida. Consultar precio.
Available also on polyamide castors. Please ask for price.
Disponible aussi avec roulettes polyamide. Consulter prix.
Auch lieferbar mit Polyamidrädern. Bitte Preis nachfragen.

P8038 Carro porta cubeta GN 2/1 / 2/1 GN transport trolley /
Chariot transport bac GN 2/1 / Transportwagen für GN Behälter 2/1



REF	
P80.380	1

No incluye cubetas GN.
GN containers not included.
Bacs GN non inclus.
GN Behälter nicht inklusive.

Disponible también con ruedas poliamida. Consultar precio.
Available also on polyamide castors. Please ask for price.
Disponible aussi avec roulettes polyamide. Consulter prix.
Auch lieferbar mit Polyamidrädern. Bitte Preis nachfragen.

REF. P80.390 / P80.380
CARRO TRANSPORTE PARA CUBETAS GN
TRANSPORT TROLLEY FOR GN CONTAINERS
CHARIOTS DE TRANSPORT POUR BACS GN
TRANSPORTWAGEN FÜR GN BAEHÄLTER

Fabricados en acero inoxidable. Ideales para el almacenaje y transporte de alimentos preparados y salsas en grandes cantidades.
Made of St/Steel. Perfect for storing and transporting large quantities of prepared food and sauces.
Fabriqués en acier inoxydable. Idéales pour le stockage et le transport d'aliments cuisinés et sauces en grandes quantités.
Hergestellt aus Edelstahl. Ideal für die Lagerung und den Transport von vorbereiteten Lebensmittel und Sossen in grossen Mengen.

P8074 Carro portacubiertos GN 1/3 y porta bandejas / Trolley cutlery dispenser GN 1/3 /
Chariot porte-ramasse couverts GN 1/3 / Transportwagen für GN 1/3 Besteckbehälter und Tablett



REF	
P80.740	1

No incluye cubetas GN.
GN containers not included.
Bacs GN non inclus.
GN Behälter nicht inklusive.

Disponible también con ruedas poliamida. Consultar precio.
Available also on polyamide castors. Please ask for price.
Disponible aussi avec roulettes polyamide. Consulter prix.
Auch lieferbar mit Polyamidrädern. Bitte Preis nachfragen.

P8057 Carro para cargas pesadas / Trolley for heavy loads / Chariot à charges lourdes / Wagen für schwere Last



REF		
P80.570		1

Carga máxima: 350 kg
Maximum load: 350 kg
Charge maximale: 350 kg
Maximale Tragkraft: 350 kg

P8054 Carro transporte bandejas 7 guías / Tray transport trolley 7 rails / Chariot transport plateaux 7 glissières / Tabletttransportwagen 7 Einschübe

REF	MEDIDA GUÍAS / SIZE OF RAILS / DIMENSIONS GLISSIÈRES / EINSCHUBGRÖSSEN mm	A x B x C mm	DISTANCIA ENTRE GUÍAS / DISTANCE BETWEEN LEVELS / ESPACE ENTRE NIVEAUX / EINSCHUBABSTAND mm	
P80.540	GN 1/1	455 x 635 x 900	75	1
P80.550	GN 2/1	660 x 750 x 900	75	1
P80.560	Pastelería / Pastry / Pâtisserie / Pâtisserie (600 x 400 mm)	525 x 700 x 900	85	1
P80.780	GN 1/1 Doble	810 x 635 x 900	75	1

Ref. P80.540

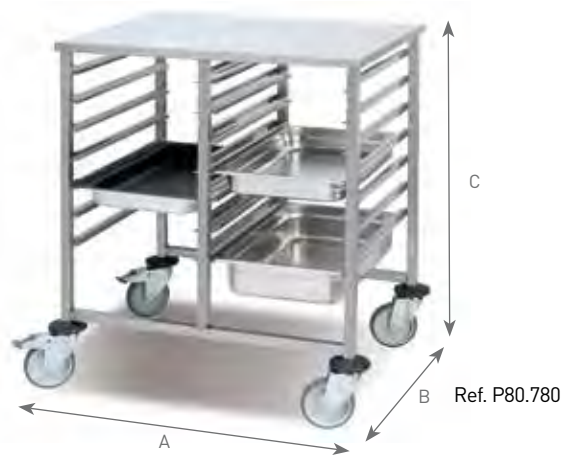

Disponible también con ruedas poliamida. Consultar precio.
Available also on polyamide castors. Please ask for price.
Disponible aussi avec roulettes polyamide. Consulter prix.
Auch lieferbar mit Polyamidrädern. Bitte Preis nachfragen.

P8061 / P8062 / P8063 Fundas desechables de polietileno para carros (rollo de 100 unidades) / Disposable covers for trolleys (pack 100 pieces) / Housses jetables pour chariots (rouleau de 100 unités) / Einweghüllen aus Polyethylen für Wagen (Rollen von 100 Stück)





REF		
P80.610	para carro 1/1 / for trolley 1/1 / pour chariot 1/1 / für Wagen 1/1	1
P80.620	para carro 2/1 / for trolley 2/1 / pour chariot 2/1 / für Wagen 2/1	1
P80.630	para carro pastelería 600 x 400 / for pastry trolley 600 x 400 / pour chariot pâtisserie 600 x 400 / für Pâtisserieswagen 600 x 400	1
P80.640	dispensador / dispenser / distributeur / Rollenhalter	1

Polietileno de densidad media.
Medium density polyethylene.
Poliéthylène de densité moyenne.
Polyethylen mittlere Stärke.

Para carros altos.
For high trolleys.
Pour chariots hauts.
Für hohe Wagen.

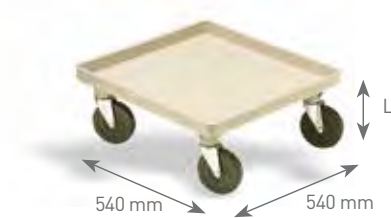
P5015 / P5017 Carro de plástico para cestas / Plastic trolley for dishwasher racks /
Chariot pour casiers à vaisselle / Plastikwagen für Spülkörbe



REF		L mm	
P5015	sin asa / without handle / sans anse / ohne Griff	230	1
P5017	con asa / with handle / avec anse / mit Griff	980	1

P8058 / P8059 Carro inox para cestas / St/steel trolley for dishwasher racks /
Chariot inox pour casiers à vaisselle / Edelstahlwagen für Spülkörbe

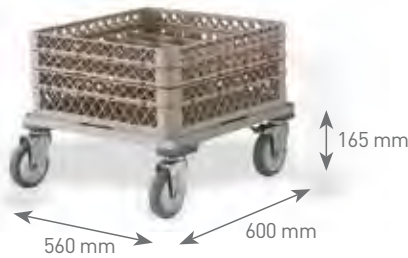

REF		
P80.590	sin asa / without handle / sans anse / ohne Griff	1
P80.580	con asa / with handle / avec anse / mit Griff	1

P8075 / P8076 / P8077 Carro para cestas Vajillas / Dishwasher rack trolley /
Chariot casiers à vaisselle / Wagen für Spülkörbe



REF	MEDIDA GUÍAS / SIZE OF RAILS / DIMENSIONS GLISSIÈRES / EINSCHUBGRÖSSEN mm	Nº GUÍAS / NR. OF LEVELS / NUM. NIVEAUX / NR. EINSCHÜBE	A x B x C mm	
P80.750	500 x 500	5	640 x 633 x 1160	1
P80.760	500 x 500	9	640 x 633 x 1710	1
P80.770	500 x 500 (doble/double)	9	1185 x 633 x 1710	1



CARRROS /
TROLLEYS /
CHARIOTS

ADC-4 Carro ajustable para platos / Adjustable dish caddy /
Chariot modulable pour assiettes / Einstellbarer Tellerwagen

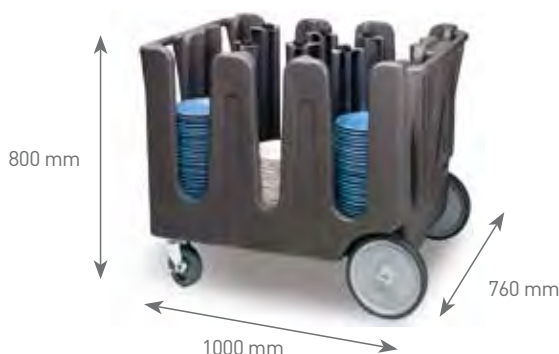

COMBINACIONES /
COMBINATIONS /
COMBINATIONS /
KOMBINATIONEN
Tamaño platos
Size plates
Taille assiettes
Tellergrösse

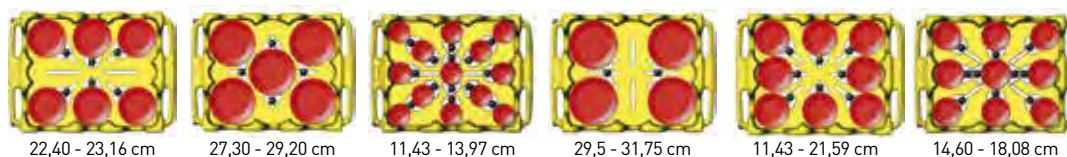

REF	
ADC-4	1

Se sirve con 4 columnas separadoras más una funda protectora.
Delivered with 4 posts plus 1 protection cover.
Livré avec 4 colonnes de séparation et 1 housse de protection.
Lieferung mit 4 Unterteilungssäulen und einer Schutzhülle.

Ajuste único y fácil por la parte superior.
Unique and easy adjustment from the top.
Reglage unique et facile de la partie supérieure.
Einzigartige und einfache Einstellung des Oberteils.

SAC-SQ5-06 Carro ajustable para platos cuadrados y redondos / Adjustable caddy for square & round dishes /
Chariot modulable pour assiettes carrées et rondes / Einstellbarer Wagen für runde und quadratische Teller



Diseño exclusivo apilable.
Unique, stackable design.
Design exclusif empilable.
Exclusives Design stapelbar.

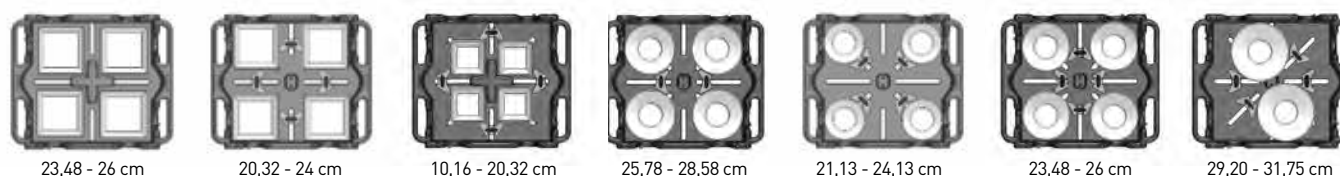
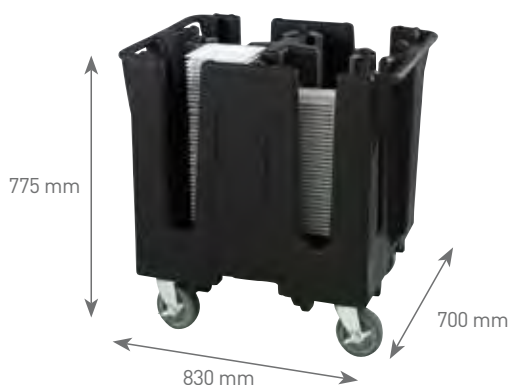

REF	
SAC-SQ5-06	1

Se sirve con 5 columnas separadoras una de ellas en forma de cruz más una funda protectora.
Delivered with 5 posts, one of them in cross shape plus 1 protection cover.
Livré avec 5 colonnes de séparation une desquelles en forme de croix plus 1 housse de protection.
Lieferung mit 5 Unterteilungssäulen, eine von Ihnen in Kreuz-form und einer Schutzhülle.

ADP Columna separadora carro platos / Post for dish trolley /
Colonne séparation chariot assiettes / Unterteilungssäule für Tellerwagen



REF	
ADP	1

Compatible ref: ADC-4 y SAC-SQ5-06.
Compatible ref: ADC-4 & SAC-SQ5-06.
Compatible réf: ADC-4 et SAC-SQ5-06.
Passend für Art.Nr.: ADC-4 und SAC-SQ5-06.

SAVC / ADVC Funda protectora de vinilo para carro platos / Vinyl cover for dish trolley /
Housse protection en vynil pour chariot assiettes / Vynilschutzhülle für Tellerwagen



REF	
SAVC	1
ADVC	1

SAVC. Funda para ref. / Cover for item / Housse pour réf. / Hülle für Art.Nr. ADC-4	ADVC. Funda para ref. / Cover for item / Housse pour réf. / Hülle für Art.Nr. SAC-SQ5-06
---	--

ICE140-06 Carro hielo / Ice caddy / Chariot à glaçons / Eiswagen



REF	KG	cm	Hcm	
ICE140-06	63,5	91,5 x 70	77,5	1



VER PRODUCTOS EN / SEE PRODUCTS ON / VOIR PRODUITS EN PAGE / SIEHE PRODUKTE IN



P. 319

CARROS /
 TROLLEYS /
 CHARIOTS



**ESTANTERÍAS /
SHELVING /
ÉTAGÈRES /
REGALE**

8.1	COMPONENTES ESTANTERÍA / SHELVING PARTS / COMPONENTS ÉTAGÈRES / REGAL KOMPONENTEN	221
8.2	KIT ESTANTERÍA / SHELVING KITS / KITS ÉTAGÈRES / REGAL SETS	225

ESTANTERÍAS MODULARES / MODULAR SHELVING / ÉTAGÈRES MODULABLES / KOMBINIERBARE REGALMODULE

-30 °C
+75 °C





FACILIDAD Y RAPIDEZ DE MONTAJE /
EASY AND QUICK ASSEMBLY /
FACILE ET RAPIDE MONTAGE /
EINFACHE UND SCHNELLE MONTAGE



ALUMINIO Y POLIPROPILENO /
ALUMINIUM AND POLYPROPYLENE /
ALUMINIUM ET POLYPROPYLÈNE /
ALUMINIUM UND POLYPROPYLEN

ANTICORROSIÓN - Fabricadas con
estructura de aluminio anodizado /
ANTICORROSIVE - Manufactured with
special anodised aluminium /
ANTI-CORROSION - Fabriquées avec
une structure en aluminium anodisé /
ANTIKORRUSION - Regale aus Spezial
eloxiertem Aluminium hergestellt

**ROBUSTEZ Y RESISTENCIA / ROBUSTNESS AND RESISTANCE /
ROBUSTESSE ET RESISTANCE / ROBUST UND RESISTENT**

150 kg  420 kg 

**COMPATIBLE / COMPATIBILITY /
COMPATIBILITÉ / PASSEND**

GN 1/1 & 2/3

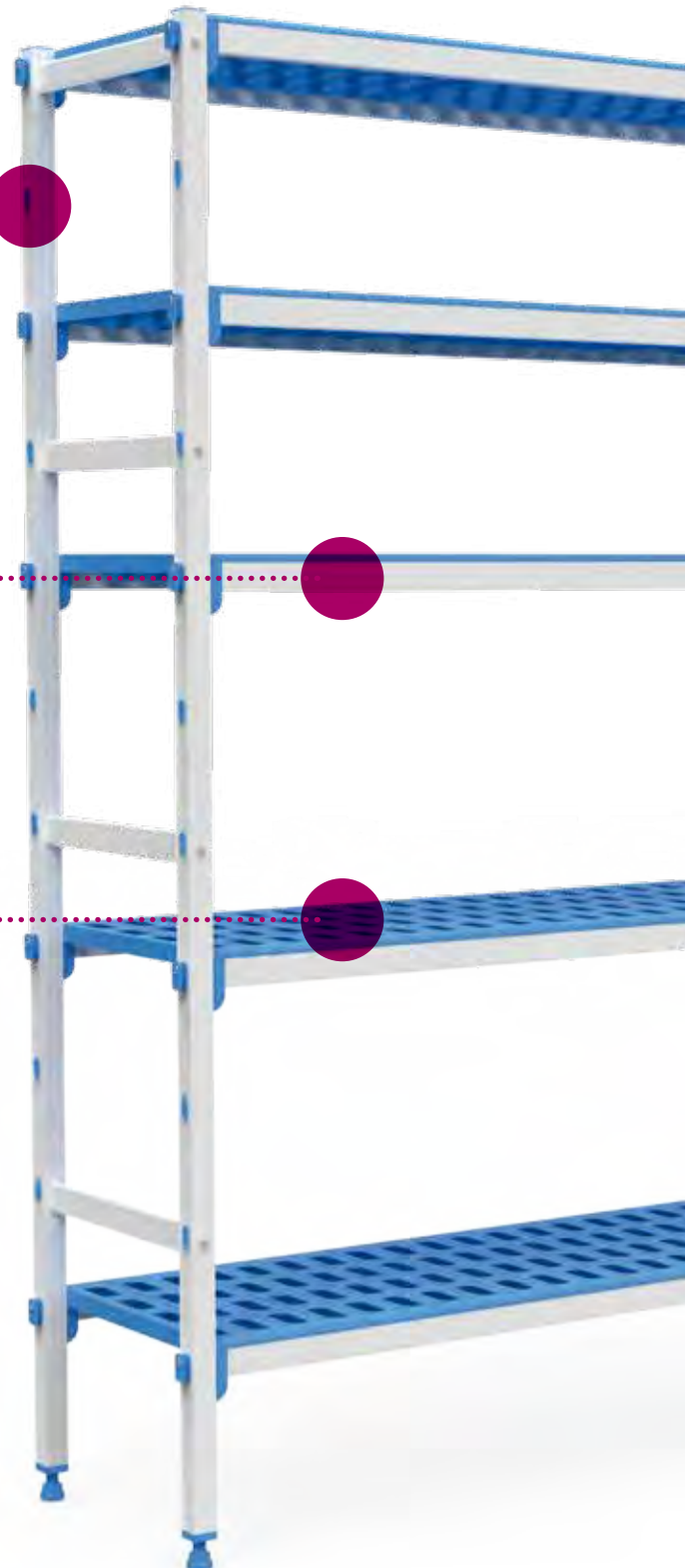

Parrillas / Rack shelves / Clayettes / Gitterböden

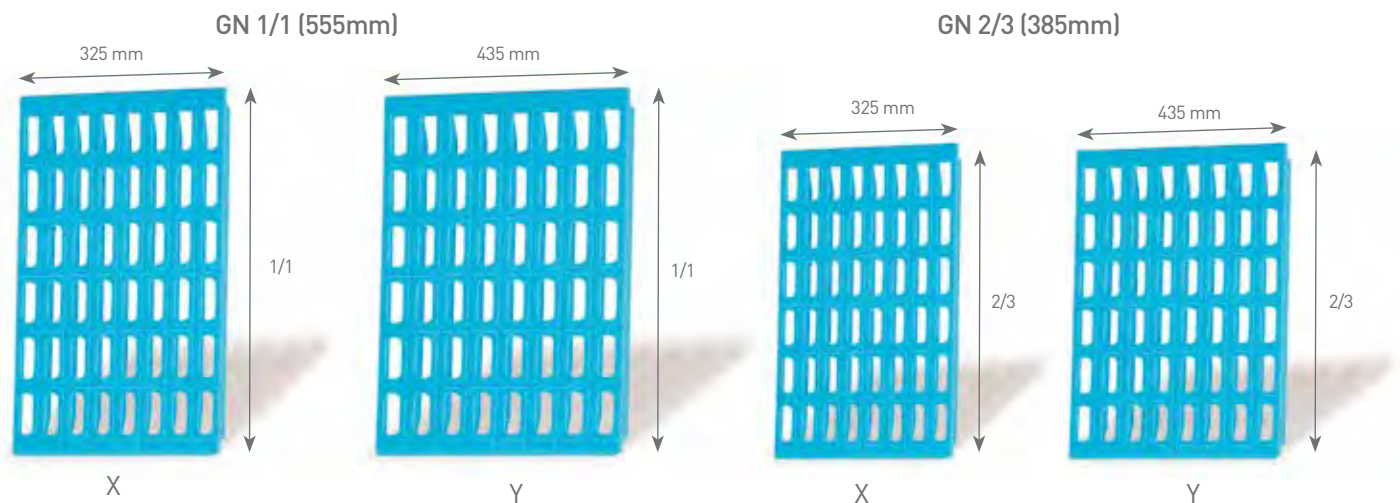

Apto para lavavajillas
Dishwasher safe
Apte pour lave-vaisselle
Geeignet für Spülmaschinen

Combinando parrillas de la misma profundidad (X/Y) permite personalizar las longitudes de las estanterías a cada una de las necesidades. (Ver en página siguiente combinaciones propuestas)

Combining rack shelves among the same group (X/Y) allows to personalize the lengths of each shelf. (Refer to next page for proposed combinations)

En combinant des clayettes du même groupe (X/Y) permet de personnaliser les longueurs des étagères à n'importe quel besoin. (Voir page suivante pour des combinaisons proposées)

Die Kombination der Gitterböden gleicher Tiefe (X/Y) erlaubt die Länge der Regale individuell je nach Bedarf zu bestimmen. (Siehe Kombinerungsvorschläge folgende Seite)

Pieza soporte travesaños / Support for crossbars / Crochet support pour largérons / Halterungsteil Traversen

Sistema especial de fijación de soporte para travesaños que ofrece la máxima seguridad, fiabilidad y robustez.

Special fixing system support for crossbars which offers the highest security, reliability and robustness.

Système spécial de fixation des supports pour longerons qui offre la sécurité, fiabilité et robustesse maximale.

Spezielles System der Halterverankerung für die Traversen, welches die höchste Sicherheit, Zuverlässigkeit und Robustheit bietet.



Pies regulables / Leveling feet / Pieds régulateurs / Regulierbare Füße

Pies regulables con rosca oculta para suelos con desniveles. Con la posibilidad de adaptar ruedas de Ø 125 mm.

Levelling feet with hidden thread, for gradient floors. It is also possible to adapt Ø 125 mm wheels.

Pieds régulateurs avec filet cache. Il est aussi possible d'y adapter des roues de Ø 125 mm.

Regulierbare Füße mit verborgenem Gewinde für unebene Böden. Mit der Möglichkeit Räder Ø 125 mm anzubringen.



Alturas estándar de los niveles / Standard heights of levels / Hauteur standard des niveaux / Standardhöhe der Ebenen

Altura 1280 mm / 3 niveles
Height 1280 mm / 3 levels
Hauteur 1280 mm / 3 niveaux
Höhe 1280 mm / 3 Ebenen

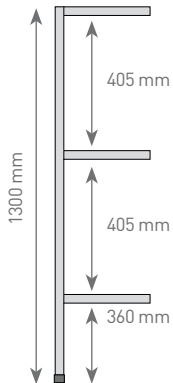

MÁS DE 2000 MM ALTURA CONSULTAR /
HIGHER THAN 2000 MM PLEASE ASK /
HAUTEUR SUPÉRIEURE À 2000 MM VEILLEZ NOUS CONSULTER /
HÖHER ALS 2000 MM BITTE FRAGEN SIE UNS

Combinaciones /
Combinations /
Combinaisons /
Kombinationen

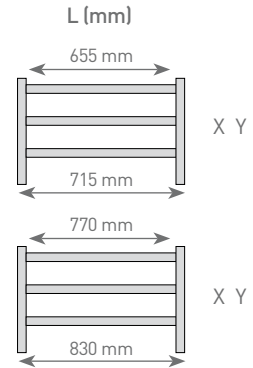

Altura 1750 mm / 3 niveles
Height 1750 mm / 3 levels
Hauteur 1750 mm / 3 niveaux
Höhe 1750 mm / 3 Ebenen

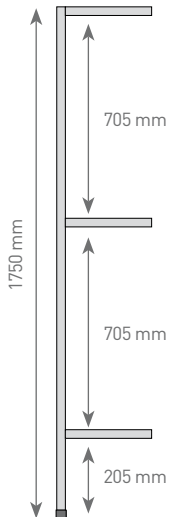

Altura 1750 mm / 4 niveles
Height 1750 mm / 4 levels
Hauteur 1750 mm / 4 niveaux
Höhe 1750 mm / 4 Ebenen

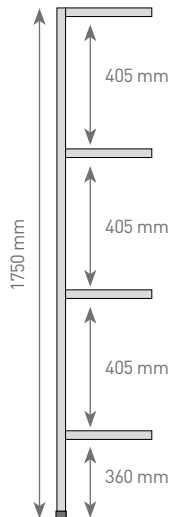

Altura 1750 mm / 5 niveles
Height 1750 mm / 5 levels
Hauteur 1750 mm / 5 niveaux
Höhe 1750 mm / 5 Ebenen

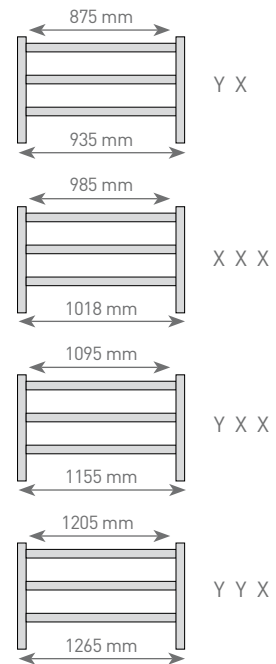
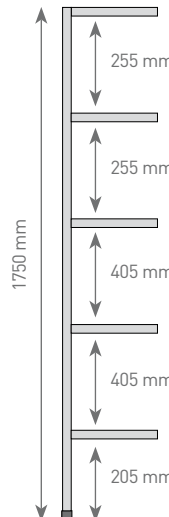

Altura 2050 mm / 4 niveles
Height 2050 mm / 4 levels
Hauteur 2050 mm / 4 niveaux
Höhe 2050 mm / 4 Ebenen

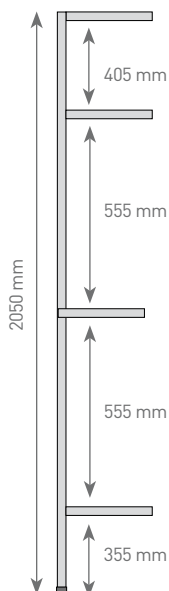

Altura 2050 mm / 5 niveles
Height 2050 mm / 5 levels
Hauteur 2050 mm / 5 niveaux
Höhe 2050 mm / 5 Ebenen

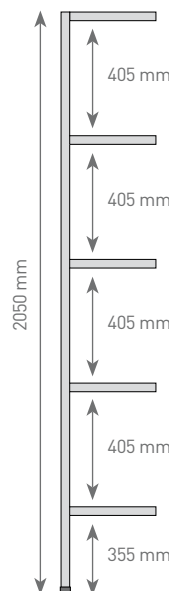

Altura 2050 mm / 6 niveles
Height 2050 mm / 6 levels
Hauteur 2050 mm / 6 niveaux
Höhe 2050 mm / 6 Ebenen

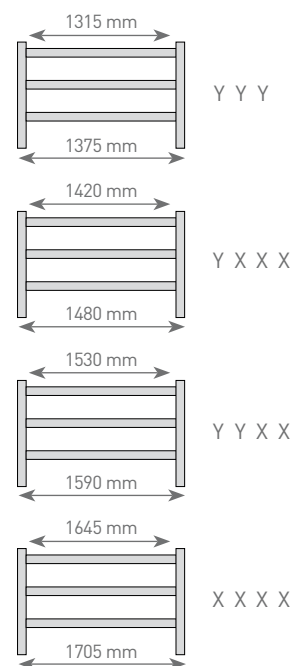
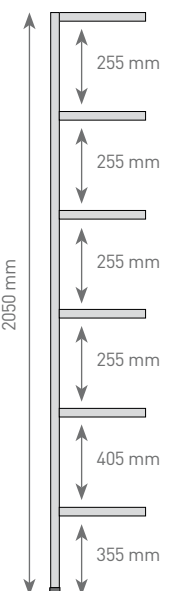

COMPONENTES /
PARTS /
COMPONENTS /
KOMPONENTEN



ESTANTERÍAS /
SHELVING /
ÉTAGÈRES

8.1 ESTANTERÍAS / SHELVING / ÉTAGÈRES / REGALE

ESTANTES (PARRILLAS + TRAVESAÑOS) /
SHELVES (RACK/SHELVES + CROSSBARS) /
NIVEAU COMPLET (CLAYETTES + LONGERONS) /
REGALE (GITTEBÖDEN + TRAVERSEN)

Fondo 385 mm. Adaptable a las cubetas gastronorm 2/3
Depth 385 mm. Suitable for 2/3 gastronorm containers
Profondeur 385 mm. Adaptable aux bacs gastronorme 2/3
Tiefe 385 mm. Passend für Gastronormbehälter 2/3

X significa una parrilla de ancho 325 mm.
Y significa una parrilla de ancho 435 mm.

X is a rack 325 mm width.
Y is a rack 435 mm width.

X est une clayette de 325 mm de largeur.
Y est une clayette de 435 mm de largeur.

X Bezeichnet einen Einlegeboden der Breite von 325 mm.
Y Bezeichnet einen Gitterboden der Breite von 435 mm.

REF	MOD	COMBINACIÓN / COMBINATION / COMBINAISON / KOMBINATION	A mm	B mm	
P7575	T61	X + X	655	385	1
P7576	T71	X + Y	770	385	1
P7577	T81	Y + Y	875	385	1
P7578	T91	X + X + X	985	385	1
P7579	T101	Y + X + X	1095	385	1
P7580	T111	Y + Y + X	1205	385	1
P7581	T131	Y + Y + Y	1315	385	1
P7582	T141	Y + X + X + X	1420	385	1
P7583	T151	Y + Y + X + X	1530	385	1
P7584	T161	Y + Y + Y + X	1645	385	1

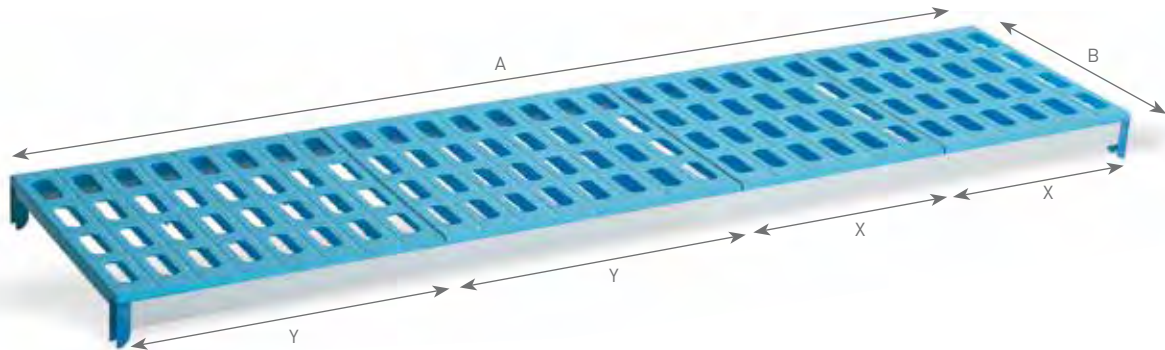

Fondo 555 mm. Adaptable a las cubetas gastronorm 1/1
Depth 555 mm. Suitable for 1/1 gastronorm containers
Profondeur 555 mm. Adaptable aux bacs gastronorme 1/1
Tiefe 555 mm. Passend für Gastronormbehälter 1/1

X significa una parrilla de ancho 325 mm.
Y significa una parrilla de ancho 435 mm.

X is a rack 325 mm width.
Y is a rack 435 mm width.

X est une clayette de 325 mm de largeur.
Y est une clayette de 435 mm de largeur.

X Bezeichnet einen Einlegeboden der Breite von 325 mm.
Y Bezeichnet einen Gitterboden der Breite von 435 mm.

REF	MOD	COMBINACIÓN / COMBINATION / COMBINAISON / KOMBINATION	A mm	B mm	
P7565	T6	X + X	655	555	1
P7566	T7	X + Y	770	555	1
P7567	T8	Y + Y	875	555	1
P7568	T9	X + X + X	985	555	1
P7569	T10	Y + X + X	1095	555	1
P7570	T11	Y + Y + X	1205	555	1
P7571	T13	Y + Y + Y	1315	555	1
P7572	T14	Y + X + X + X	1420	555	1
P7573	T15	Y + Y + X + X	1530	555	1
P7574	T16	Y + Y + Y + X	1645	555	1

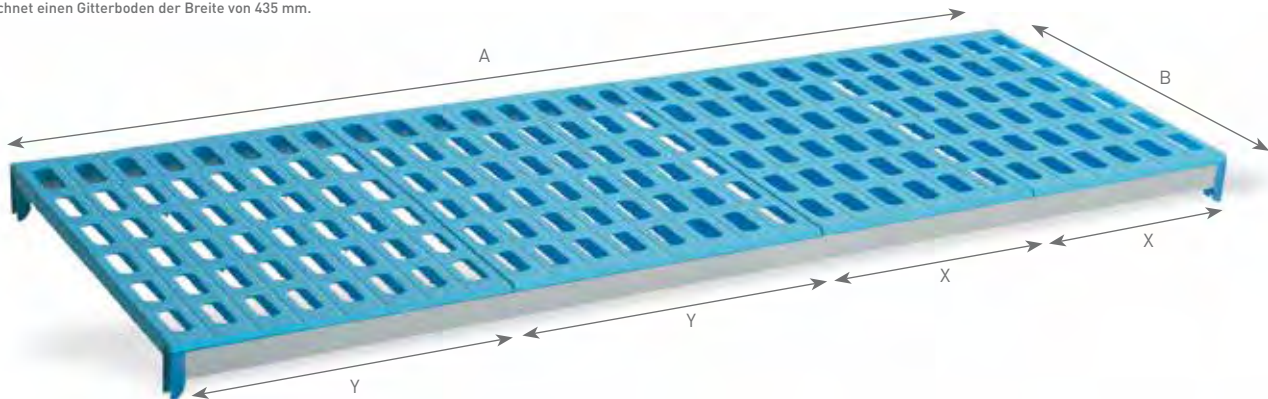

Soportes laterales / Lateral supports / Support latéraux / Seitliche Ständer



REF	MOD	A mm	B mm	NIVELES / LEVELS / NIVEAUX / EBENEN	
P7585	S1	1750	555	3	1
P7586	S2	1750	555	4	1
P7587	S3	1750	555	5	1
P7646	S0	2000	555	4	1
P7588	S4	2000	555	5	1
P7589	S5	2000	555	6	1
P7590	S6	1300	555	3	1
P7591	S7	1750	385	3	1
P7592	S8	1750	385	4	1
P7593	S9	1750	385	5	1
P7647	S13	2000	385	4	1
P7594	S10	2000	385	5	1
P7595	S11	2000	385	6	1
P7596	S12	1300	385	3	1

2 Fondos disponibles :
555 mm, gastronorm 1/1
385 mm, gastronorm 2/3

2 Available depths:
555 mm, 1/1 gastronorm
385 mm, 2/3 gastronorm

2 profondeurs disponibles:
555 mm, gastronorme 1/1
385 mm, gastronorme 2/3

2 Tiefen erhältlich:
555 mm, Gastronorm 1/1
385 mm, Gastronorm 2/3

Soportes laterales con ruedas / Lateral support with wheels / Supports latéraux avec roues / Seitliche Ständer mit Räder

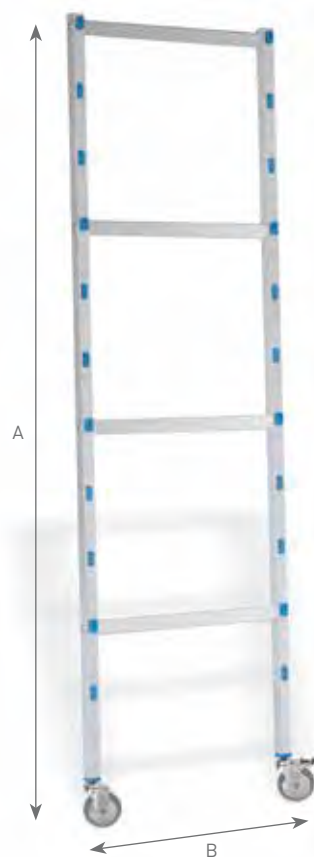

REF	A mm*	B mm	NIVELES / LEVELS / NIVEAUX / EBENEN	
P7597	1.880	555	3	1
P7598	1.880	555	4	1
P7599	1.880	555	5	1

Para montar estanterías móviles con ruedas.
To assembly mobile shelving with wheels.
Pour monter étagères mobiles avec roues.
Für die Montage von mobilen Regalen mit Räder.

* Altura con rueda incluida
* Height including wheel
* Hauteur avec la roue
* Höhe inklusive Räder

Ruedas de Ø 125 mm, dos de ellas con freno.
Wheels Ø 125 mm, two of them with brake.
Roues de Ø 125 mm, deux avec frein.
Räder Ø 125 mm, zwei von ihnen mit Bremsen.

No se recomiendan longitudes de travesaños superiores a 1400 mm.
We do not advise crossbars longer than 1400 mm.
Nous ne conseillons pas des lonerons plus longues de 1400 mm.
Wir empfehlen nicht die Länge der Traversen von 1400 mm zu überschreiten.

Soporte fijación estantería / Shelf support fixing / Support fixation étagère / Regal Fixierhalterung

N



REF	
P76.430	1

Conjunto de 2 soportes /
Two pieces kit /
Kit deux pièces /
Kit mit 2 Stück

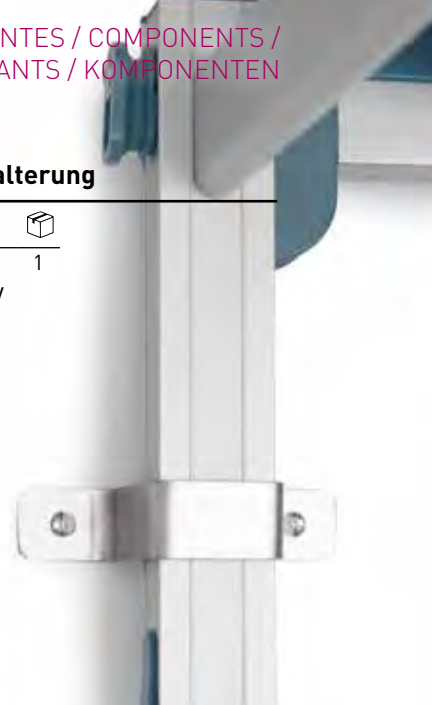



Travesaños / Crossbars / Longérons / Traversen

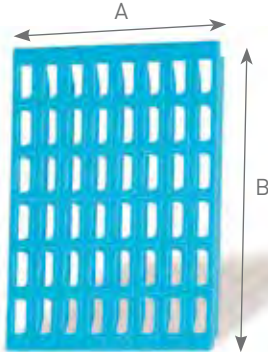

REF	L mm	
P7632	655	1
P7633	770	1
P7634	875	1
P7635	985	1
P7636	1095	1
P7637	1205	1
P7638	1315	1
P7639	1420	1
P7640	1530	1
P7641	1645	1

Parrillas / Rack-shelves / Clayettes / Einlegeböden



REF	TIPO / TYPE	A mm	B mm	GN		
				Para / For / Pour / Für		
P7628	Y	435	555	1/1		1
P7629	X	325	555	1/1		1
P7630	Y	435	385	2/3		1
P7631	X	325	385	2/3		1

Ganchos para formar ángulos / Hooks to form angles /
Crochets pour faire les angles / Haken für Winkelbildung



REF	
P7642	1

Pieza soporte para travesaños / Support for crossbars /
Support pour largérons / Halterteil für Traversen



REF	
P7643	1

Bancadas / Bench / BanCS / Bänke

Diseñadas para su uso en lugares donde se prohíbe depositar cajas directamente en el suelo. Capacidad de carga de hasta 175 Kg por bancada, repartidos a lo largo de la bancada. Pie regulable para suelos desnivelados.

Designed to be used in places where it is forbidden to put boxes directly on the floor. Maximum load charge 175 Kg per bench, distributed weight throughout the bench. Leveling feet for gradient floors.

Dessinés pour être utilisés quand il est interdit de poser les boîtes directement par terre. Charge maximale 175 Kg, distribués tout au long du banc. Pieds régulateurs pour sols inégaux.

Design für den Gebrauch in Räumen, in denen es verboten ist Kisten direkt auf den Boden zu stellen. Die Tragkraft beträgt bis zu 175 Kg pro Bank, wenn die Last gleichmässig auf der Länge verteilt ist. Regulierbare Füße für unebene Böden.

REF	A mm	B mm	C mm	
P7603	715	555	280	1
P7604	830	555	280	1
P7605	935	555	280	1
P7606	1045	555	280	1
P7607	1155	555	280	1
P7608	1265	555	280	1
P7609	1375	555	280	1
P7610	1480	555	280	1
P7611	715	385	280	1
P7612	830	385	280	1
P7613	935	385	280	1
P7614	1045	385	280	1
P7615	1155	385	280	1
P7616	1260	385	280	1
P7617	1375	385	280	1
P7618	1480	385	280	1

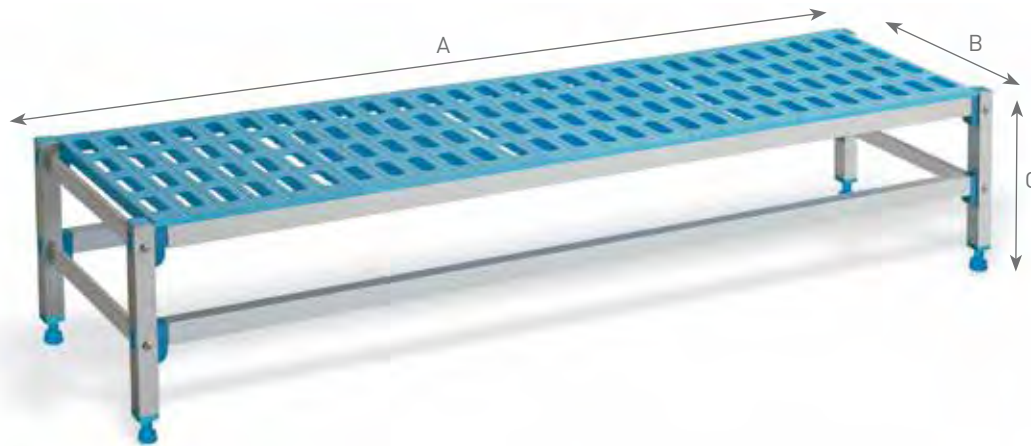

Conjunto completo con ruedas / Complet kits with wheels / Kit préparés avec roues / Komplettes Set mit Rädern



Reforzada /
Reinforced /
Renforcée /
Verstärkte

REF	A mm	B mm	C mm	TIPO / TYPE	NIVELES / LEVELS / NIVEAUX / EBENEN	
P7145R	1145	555	1880	GN 1/1	3	1
P7004R	1145	385	1880	GN 2/3	3	1
P7146R	1265	555	1880	GN 1/1	3	1
P7005R	1265	385	1880	GN 2/3	3	1
P7147R	1375	555	1880	GN 1/1	3	1
P7006R	1375	385	1880	GN 2/3	3	1

3 NIVELES /
LEVELS /
NIVEAUX /
EBENEN

Kits completos / Complete kits / Kits préparés / Komplettssets

Distintas combinaciones /
Diferent combinations /
Diferentes combinaisons /
Verschiedene Kombinationen

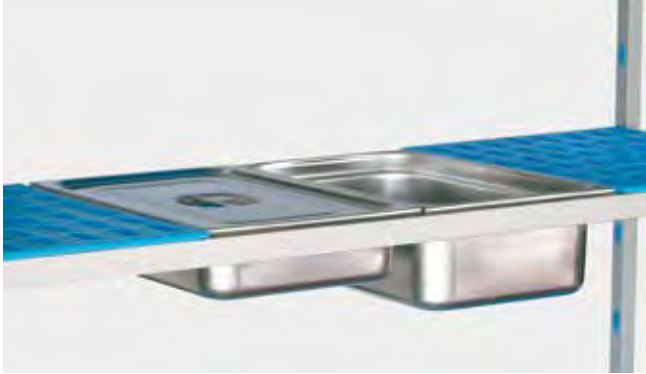

Compatible con cubetas 2/3 /
Compatible with 2/3 containers /
Compatible avec bacs 2/3 /
Kombinierbar mit Behältern 2/3

Compatible con cubetas 1/1 /
Compatible with 1/1 containers /
Compatible avec bacs 1/1 /
Kombinierbar mit Behältern 1/1

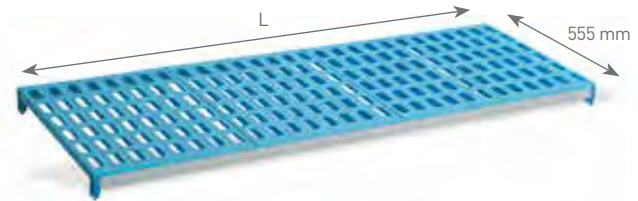
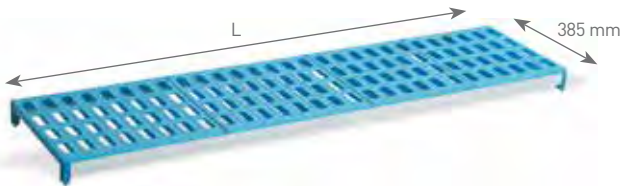

REF	L mm
P7000	715
P7001	830
P7002	935
P7003	1045
P7004	1155
P7005	1265
P7006	1375
P7007	1480
P7008	1590
P7009	1705
P7010	1840
P7011	1950
P7012	2060
P7013	2170
P7014	2280
P7015	2388
P7016	2496
P7017	2608
P7018	2720
P7019	2825
P7020	2930
P7021	3040
P7022	3150
P7023	3265

REF	L mm
P7024	3380
P7025	3513
P7026	3621
P7027	3729
P7028	3841
P7029	3953
P7030	4065
P7031	4170
P7032	4275
P7033	4380
P7034	4490
P7035	4600
P7036	4710
P7037	4825
P7038	4940
P7039	5055
P7040	5186
P7041	5298
P7042	5410
P7043	5515
P7044	5620
P7045	5725
P7046	5830

REF	L mm
P7141	715
P7142	830
P7143	935
P7144	1045
P7145	1155
P7146	1263
P7147	1375
P7148	1480
P7149	1590
P7150	1705
P7151	1840
P7152	1950
P7153	2060
P7154	2170
P7155	2280
P7156	2388
P7157	2496
P7158	2608
P7159	2720
P7160	2825
P7161	2930
P7162	3040
P7163	3150
P7164	3265

REF	L mm
P7165	3380
P7166	3513
P7167	3621
P7168	3729
P7169	3841
P7170	3953
P7171	4065
P7172	4170
P7173	4275
P7174	4380
P7175	4490
P7176	4600
P7177	4710
P7178	4825
P7179	4940
P7180	5055
P7181	5186
P7182	5298
P7183	5410
P7184	5515
P7185	5620
P7186	5725
P7187	5830

3 NIVELES /
LEVELS /
NIVEAUX /
EBENEN

Estanterías angulares / Shelvings for angle / Étagères angulaires / Rechtwinklige Regale

Distintas combinaciones /
Diferent combinations /
Diferentes combinaisons /
Verschiedene Kombinationen



Incluido / Included / Compris / Inklusive:
Ganchos para formar ángulos /
Hooks to form angles /
Crochets pour faire les angles /
Haken für Winkelbildung



Compatible con cubetas 2/3 /
Compatible with 2/3 containers /
Compatible avec bacs 2/3 /
Kombinierbar mit Behältern 2/3

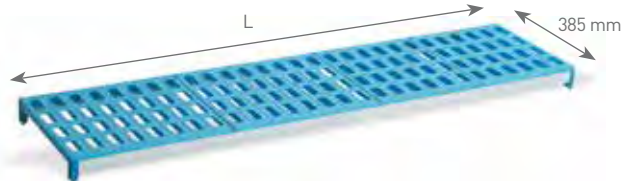

Compatible con cubetas 1/1 /
Compatible with 1/1 containers /
Compatible avec bacs 1/1 /
Kombinierbar mit Behältern 1/1

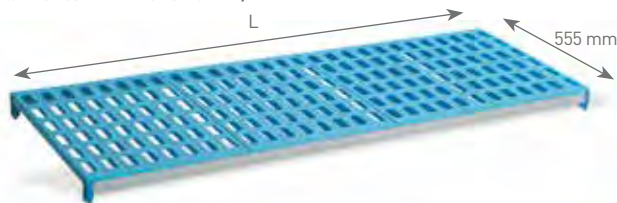

REF	L mm
P7282	685
P7283	800
P7284	905
P7285	1015
P7286	1125
P7287	1233
P7288	1345
P7289	1450
P7290	1560
P7291	1675
P7292	1810
P7293	1920
P7294	2030
P7295	2140
P7296	2250
P7297	2358
P7298	2466
P7299	2578
P7300	2690
P7301	2795
P7302	2900
P7303	3010
P7304	3120
P7305	3235

REF	L mm
P7306	3350
P7307	3483
P7308	3591
P7309	3699
P7310	3811
P7311	3923
P7312	4035
P7313	4140
P7314	4245
P7315	4350
P7316	4460
P7317	4570
P7318	4680
P7319	4795
P7320	4910
P7321	5025
P7322	5156
P7323	5268
P7324	5380
P7325	5485
P7326	5590
P7327	5695
P7328	5800

REF	L mm
P7423	685
P7424	800
P7425	905
P7426	1015
P7427	1125
P7428	1233
P7429	1345
P7430	1450
P7431	1560
P7432	1675
P7433	1810
P7434	1920
P7435	2030
P7436	2140
P7437	2250
P7438	2358
P7439	2466
P7440	2578
P7441	2690
P7442	2795
P7443	2900
P7444	3010
P7445	3120
P7446	3235

REF	L mm
P7447	3350
P7448	3483
P7449	3591
P7450	3699
P7451	3811
P7452	3923
P7453	4035
P7454	4140
P7455	4245
P7456	4350
P7457	4460
P7458	4570
P7459	4680
P7460	4795
P7461	4910
P7462	5025
P7463	5156
P7464	5268
P7465	5380
P7466	5485
P7467	5590
P7468	5695
P7469	5800

4 NIVELES /
LEVELS /
NIVEAUX /
EBENEN

Kits completos / Complete kits / Kits préparés / Komplettssets

Distintas combinaciones /
Diferent combinations /
Diferentes combinaisons /
Verschiedene Kombinationen

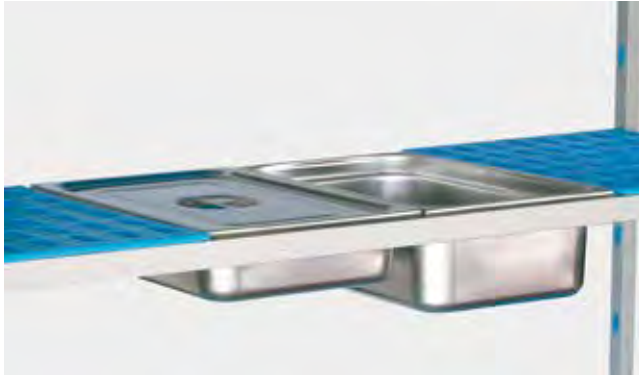

Compatible con cubetas 2/3 /
Compatible with 2/3 containers /
Compatible avec bacs 2/3 /
Kombinierbar mit Behältern 2/3

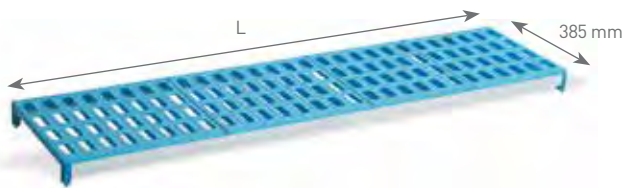

REF	L mm	REF	L mm
P7047	715	P7071	3380
P7048	830	P7072	3513
P7049	935	P7073	3621
P7050	1045	P7074	3729
P7051	1155	P7075	3841
P7052	1263	P7076	3953
P7053	1375	P7077	4065
P7054	1480	P7078	4170
P7055	1590	P7079	4275
P7056	1705	P7080	4380
P7057	1840	P7081	4490
P7058	1950	P7082	4600
P7059	2060	P7083	4710
P7060	2170	P7084	4825
P7061	2280	P7085	4940
P7062	2388	P7086	5055
P7063	2496	P7087	5186
P7064	2608	P7088	5298
P7065	2720	P7089	5410
P7066	2825	P7090	5515
P7067	2930	P7091	5620
P7068	3040	P7092	5725
P7069	3150	P7093	5830
P7070	3265		



Compatible con cubetas 1/1 /
Compatible with 1/1 containers /
Compatible avec bacs 1/1 /
Kombinierbar mit Behältern 1/1

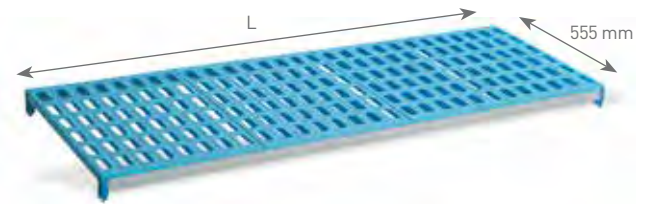

REF	L mm	REF	L mm
P7188	715	P7212	3380
P7189	830	P7213	3513
P7190	935	P7214	3621
P7191	1045	P7215	3729
P7192	1155	P7216	3841
P7193	1263	P7217	3953
P7194	1375	P7218	4065
P7195	1480	P7219	4170
P7196	1590	P7220	4275
P7197	1705	P7221	4380
P7198	1840	P7222	4490
P7199	1950	P7223	4600
P7200	2060	P7224	4710
P7201	2170	P7225	4825
P7202	2280	P7226	4940
P7203	2388	P7227	5055
P7204	2496	P7228	5186
P7205	2608	P7229	5298
P7206	2720	P7230	5410
P7207	2825	P7231	5515
P7208	2930	P7232	5620
P7209	3040	P7233	5725
P7210	3150	P7234	5830
P7211	3265		

4 NIVELES /
LEVELS /
NIVEAUX /
EBEBEN

Estanterías angulares / Shelvings for angle / Étagères angulaires / Rechtwinklige Regale

Distintas combinaciones /
Diferent combinations /
Diferentes combinaisons /
Verschiedene Kombinationen



Incluido / Included / Compris / Inklusive:
Ganchos para formar ángulos /
Hooks to form angles /
Crochets pour faire les angles /
Haken für Winkelbildung

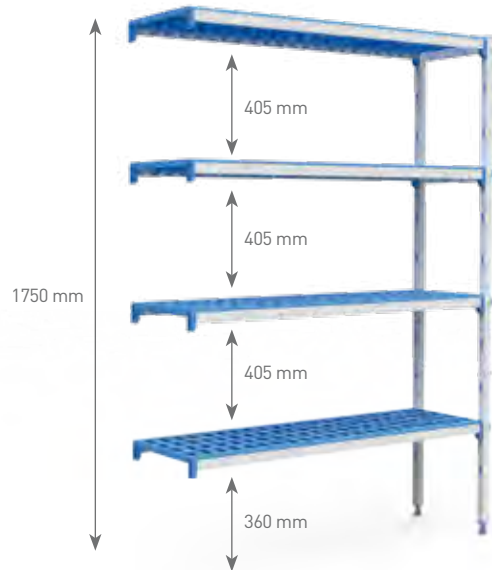

Compatible con cubetas 2/3 /
Compatible with 2/3 containers /
Compatible avec bacs 2/3 /
Kombinierbar mit Behältern 2/3

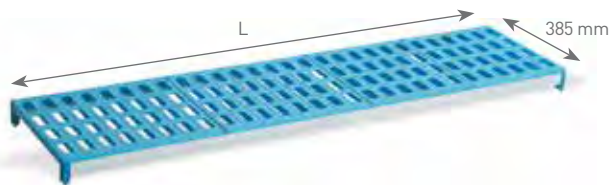

Compatible con cubetas 1/1 /
Compatible with 1/1 containers /
Compatible avec bacs 1/1 /
Kombinierbar mit Behältern 1/1

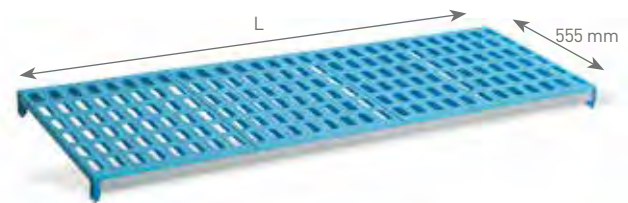

REF	L mm
P7329	685
P7330	800
P7331	905
P7332	1015
P7333	1125
P7334	1233
P7335	1345
P7336	1450
P7337	1560
P7338	1675
P7339	1810
P7340	1920
P7341	2030
P7342	2140
P7343	2250
P7344	2358
P7345	2466
P7346	2578
P7347	2690
P7348	2795
P7349	2900
P7350	3010
P7351	3120
P7352	3235

REF	L mm
P7353	3350
P7354	3483
P7355	3591
P7356	3699
P7357	3811
P7358	3923
P7359	4035
P7360	4140
P7361	4245
P7362	4350
P7363	4460
P7364	4570
P7365	4680
P7366	4795
P7367	4910
P7368	5025
P7369	5156
P7370	5268
P7371	5380
P7372	5485
P7373	5590
P7374	5695
P7375	5800

REF	L mm
P7470	685
P7471	800
P7472	905
P7473	1015
P7474	1125
P7475	1233
P7476	1345
P7477	1450
P7478	1560
P7479	1675
P7480	1810
P7481	1920
P7482	2030
P7483	2140
P7484	2250
P7485	2358
P7486	2466
P7487	2578
P7488	2690
P7489	2795
P7490	2900
P7491	3010
P7492	3120
P7493	3235

REF	L mm
P7494	3350
P7495	3483
P7496	3591
P7497	3699
P7498	3811
P7499	3923
P7500	4035
P7501	4140
P7502	4245
P7503	4350
P7504	4460
P7505	4570
P7506	4680
P7507	4795
P7508	4910
P7509	5025
P7510	5156
P7511	5268
P7512	5380
P7513	5485
P7514	5590
P7515	5695
P7516	5800

5 NIVELES /
LEVELS /
NIVEAUX /
EBENEN

Kits completos / Complete kits / Kits préparés / Komplettssets

Distintas combinaciones /
Diferent combinations /
Diferentes combinaisons /
Verschiedene Kombinationen

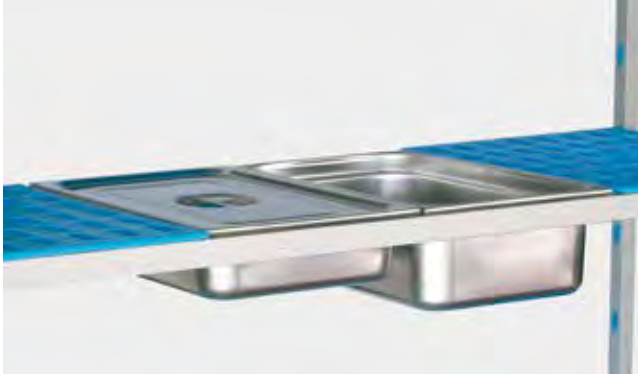

Compatible con cubetas 2/3 /
Compatible with 2/3 containers /
Compatible avec bacs 2/3 /
Kombinierbar mit Behältern 2/3

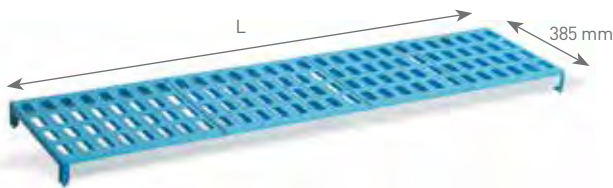

Compatible con cubetas 1/1 /
Compatible with 1/1 containers /
Compatible avec bacs 1/1 /
Kombinierbar mit Behältern 1/1

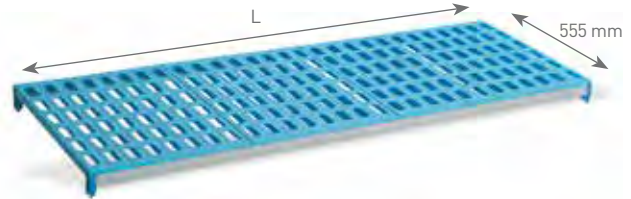

REF	L mm
P7094	715
P7095	830
P7096	935
P7097	1045
P7098	1155
P7099	1263
P7100	1375
P7101	1480
P7102	1590
P7103	1705
P7104	1840
P7105	1950
P7106	2060
P7107	2170
P7108	2280
P7109	2388
P7110	2496
P7111	2608
P7112	2720
P7113	2825
P7114	2930
P7115	3040
P7116	3150
P7117	3265

REF	L mm
P7118	3380
P7119	3513
P7120	3621
P7121	3729
P7122	3841
P7123	3953
P7124	4065
P7125	4170
P7126	4275
P7127	4380
P7128	4490
P7129	4600
P7130	4710
P7131	4825
P7132	4940
P7133	5055
P7134	5186
P7135	5298
P7136	5410
P7137	5515
P7138	5620
P7139	5725
P7140	5830

REF	L mm
P7235	715
P7236	830
P7237	935
P7238	1045
P7239	1155
P7240	1263
P7241	1375
P7242	1480
P7243	1590
P7244	1705
P7245	1840
P7246	1950
P7247	2060
P7248	2170
P7249	2280
P7250	2388
P7251	2496
P7252	2608
P7253	2720
P7254	2825
P7255	2930
P7256	3040
P7257	3150
P7258	3265

REF	L mm
P7259	3380
P7260	3513
P7261	3621
P7262	3729
P7263	3841
P7264	3953
P7265	4065
P7266	4170
P7267	4275
P7268	4380
P7269	4490
P7270	4600
P7271	4710
P7272	4825
P7273	4940
P7274	5055
P7275	5186
P7276	5298
P7277	5410
P7278	5515
P7279	5620
P7280	5725
P7281	5830

5 NIVELES /
LEVELS /
NIVEAUX /
EBENEN

Estanterías angulares / Shelvings for angle / Étagères angulaires / Rechtwinklige Regale

Distintas combinaciones /
Diferent combinations /
Diferentes combinaisons /
Verschiedene Kombinationen



Incluido / Included / Compris / Inklusive:
Ganchos para formar ángulos /
Hooks to form angles /
Crochets pour faire les angles /
Haken für Winkelbildung

Compatible con cubetas 2/3 /
Compatible with 2/3 containers /
Compatible avec bacs 2/3 /
Kombinierbar mit Behältern 2/3

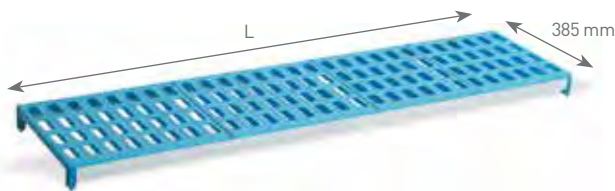

REF	L mm	REF	L mm
P7376	685	P7400	3350
P7377	800	P7401	3483
P7378	905	P7402	3591
P7379	1015	P7403	3699
P7380	1125	P7404	3811
P7381	1233	P7405	3923
P7382	1345	P7406	4035
P7383	1450	P7407	4140
P7384	1560	P7408	4245
P7385	1675	P7409	4350
P7386	1810	P7410	4460
P7387	1920	P7411	4570
P7388	2030	P7412	4680
P7389	2140	P7413	4795
P7390	2250	P7414	4910
P7391	2358	P7415	5025
P7392	2466	P7416	5156
P7393	2578	P7417	5268
P7394	2690	P7418	5380
P7395	2795	P7419	5485
P7396	2900	P7420	5590
P7397	3010	P7421	5695
P7398	3120	P7422	5800
P7399	3235		



Compatible con cubetas 1/1 /
Compatible with 1/1 containers /
Compatible avec bacs 1/1 /
Kombinierbar mit Behältern 1/1

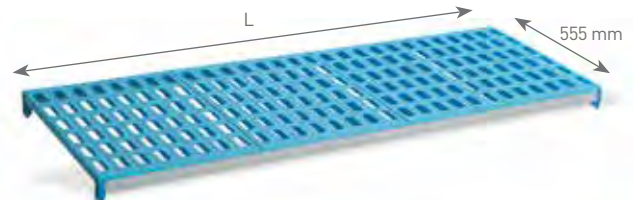

REF	L mm	REF	L mm
P7517	685	P7541	3350
P7518	800	P7542	3483
P7519	905	P7543	3591
P7520	1015	P7544	3699
P7521	1125	P7545	3811
P7522	1233	P7546	3923
P7523	1345	P7547	4035
P7524	1450	P7548	4140
P7525	1560	P7549	4245
P7526	1675	P7550	4350
P7527	1810	P7551	4460
P7528	1920	P7552	4570
P7529	2030	P7553	4680
P7530	2140	P7554	4795
P7531	2250	P7555	4910
P7532	2358	P7556	5025
P7533	2466	P7557	5156
P7534	2578	P7558	5268
P7535	2690	P7559	5380
P7536	2795	P7560	5485
P7537	2900	P7561	5590
P7538	3010	P7562	5695
P7539	3120		5800
P7540	3235		

FONDO 385 mm. Adaptable a GASTRONORM 2/3 / DEEPth 385 mm. Suitable for 2/3 GASTRONORM /
PROFONDEUR 385 mm. Adaptable aux GASTRONORME 2/3 / Tiefe 385 mm. Passend für Gastronorm 2/3

REF. 3 niveles 3 levels 3 niveaux 3 Ebenen	DESGLOSE BREAKDOWN COMPOSITION AUFLISTUNG
P7000	2 S7 + 3 T61
P7001	2 S7 + 3 T71
P7002	2 S7 + 3 T81
P7003	2 S7 + 3 T91
P7004	2 S7 + 3 T101
P7005	2 S7 + 3 T111
P7006	2 S7 + 3 T131
P7007	2 S7 + 3 T141
P7008	2 S7 + 3 T151
P7009	2 S7 + 3 T161
P7010	3 S7 + 6 T81
P7011	3 S7 + 3 T81 + 3 T91
P7012	3 S7 + 6 T91
P7013	3 S7 + 3 T91 + 3 T101
P7014	3 S7 + 6 T101
P7015	3 S7 + 3 T101 + 3 T111
P7016	3 S7 + 6 T111
P7017	3 S7 + 3 T111 + 3 T131
P7018	3 S7 + 6 T131
P7019	3 S7 + 3 T131 + 3 T141
P7020	3 S7 + 6 T141
P7021	3 S7 + 3 T141 + 3 T151
P7022	3 S7 + 6 T151
P7023	3 S7 + 3 T151 + 3 T161
P7024	3 S7 + 6 T161
P7025	4 S7 + 6 T101 + 3 T111
P7026	4 S7 + 3 T101 + 6 T111
P7027	4 S7 + 9 T111
P7028	4 S7 + 6 T111 + 3 T131
P7029	4 S7 + 3 T111 + 6 T131
P7030	4 S7 + 9 T131
P7031	4 S7 + 6 T131 + 3 T141
P7032	4 S7 + 3 T131 + 6 T141
P7033	4 S7 + 9 T141
P7034	4 S7 + 6 T141 + 3 T151
P7035	4 S7 + 3 T141 + 6 T151
P7036	4 S7 + 9 T151
P7037	4 S7 + 6 T151 + 3 T161
P7038	4 S7 + 3 T151 + 6 T161
P7039	4 S7 + 9 T161
P7040	5 S7 + 6 T111 + 6 T131
P7041	5 S7 + 3 T111 + 9 T131
P7042	5 S7 + 12 T131
P7043	5 S7 + 3 T141 + 9 T131
P7044	5 S7 + 6 T131 + 6 T141
P7045	5 S7 + 3 T131 + 9 T141
P7046	5 S7 + 12 T141

REF. 4 niveles 4 levels 4 niveaux 4 Ebenen	DESGLOSE BREAKDOWN COMPOSITION AUFLISTUNG
P7047	2 S8 + 4 T61
P7048	2 S8 + 4 T71
P7049	2 S8 + 4 T81
P7050	2 S8 + 4 T91
P7051	2 S8 + 4 T101
P7052	2 S8 + 4 T111
P7053	2 S8 + 4 T131
P7054	2 S8 + 4 T141
P7055	2 S8 + 4 T151
P7056	2 S8 + 4 T161
P7057	3 S8 + 8 T81
P7058	3 S8 + 4 T81 + 4 T91
P7059	3 S8 + 8 T91
P7060	3 S8 + 4 T91 + 4 T101
P7061	3 S8 + 8 T101
P7062	3 S8 + 4 T101 + 4 T111
P7063	3 S8 + 8 T111
P7064	3 S8 + 4 T111 + 4 T131
P7065	3 S8 + 8 T131
P7066	3 S8 + 4 T131 + 4 T141
P7067	3 S8 + 8 T141
P7068	3 S8 + 4 T141 + 4 T151
P7069	3 S8 + 8 T151
P7070	3 S8 + 4 T151 + 4 T161
P7071	3 S8 + 8 T161
P7072	4 S8 + 8 T101 + 4 T111
P7073	4 S8 + 4 T101 + 8 T111
P7074	4 S8 + 12 T111
P7075	4 S8 + 8 T111 + 4 T131
P7076	4 S8 + 4 T111 + 8 T131
P7077	4 S8 + 12 T131
P7078	4 S8 + 8 T131 + 4 T141
P7079	4 S8 + 4 T131 + 8 T141
P7080	4 S8 + 12 T141
P7081	4 S8 + 8 T141 + 4 T151
P7082	4 S8 + 4 T141 + 8 T151
P7083	4 S8 + 12 T151
P7084	4 S8 + 8 T151 + 4 T161
P7085	4 S8 + 4 T151 + 8 T161
P7086	4 S8 + 12 T161
P7087	5 S8 + 8 T111 + 8 T131
P7088	5 S8 + 4 T111 + 12 T131
P7089	5 S8 + 16 T131
P7090	5 S8 + 4 T141 + 12 T131
P7091	5 S8 + 8 T131 + 8 T141
P7092	5 S8 + 4 T131 + 12 T141
P7093	5 S8 + 16 T141

REF. 5 niveles 5 levels 5 niveaux 5 Ebenen	DESGLOSE BREAKDOWN COMPOSITION AUFLISTUNG
P7094	2 S9 + 5 T61
P7095	2 S9 + 5 T71
P7096	2 S9 + 5 T81
P7097	2 S9 + 5 T91
P7098	2 S9 + 5 T101
P7099	2 S9 + 5 T111
P7100	2 S9 + 5 T131
P7101	2 S9 + 5 T141
P7102	2 S9 + 5 T151
P7103	2 S9 + 5 T161
P7104	3 S9 + 10 T81
P7105	3 S9 + 5 T81 + 5 T91
P7106	3 S9 + 10 T91
P7107	3 S9 + 5 T91 + 5 T101
P7108	3 S9 + 10 T101
P7109	3 S9 + 5 T101 + 5 T111
P7110	3 S9 + 10 T111
P7111	3 S9 + 5 T111 + 5 T131
P7112	3 S9 + 10 T131
P7113	3 S9 + 5 T131 + 5 T141
P7114	3 S9 + 10 T141
P7115	3 S9 + 5 T141 + 5 T151
P7116	3 S9 + 10 T151
P7117	3 S9 + 5 T151 + 5 T161
P7118	3 S9 + 10 T161
P7119	4 S9 + 10 T101 + 5 T111
P7120	4 S9 + 5 T101 + 10 T111
P7121	4 S9 + 15 T111
P7122	4 S9 + 10 T111 + 5 T131
P7123	4 S9 + 5 T111 + 10 T131
P7124	4 S9 + 15 T131
P7125	4 S9 + 10 T131 + 5 T141
P7126	4 S9 + 5 T131 + 10 T141
P7127	4 S9 + 15 T141
P7128	4 S9 + 10 T141 + 5 T151
P7129	4 S9 + 5 T141 + 10 T151
P7130	4 S9 + 15 T151
P7131	4 S9 + 10 T151 + 5 T161
P7132	4 S9 + 5 T151 + 10 T161
P7133	4 S9 + 15 T161
P7134	5 S9 + 10 T111 + 10 T131
P7135	5 S9 + 5 T111 + 15 T131
P7136	5 S9 + 20 T131
P7137	5 S9 + 5 T141 + 15 T131
P7138	5 S9 + 10 T131 + 10 T141
P7139	5 S9 + 5 T131 + 15 T141
P7140	5 S9 + 20 T141

FONDO 555 mm. Adaptable a GASTRONORM 1/1 / DEPTH 555 mm. Suitable for 1/1 GASTRONORM /
PROFONDEUR 555 mm. Adaptable aux GASTRONORME 1/1 / Tiefe 555 mm. Passend für Gastronorm 1/1

REF. 3 niveles 3 levels 3 niveaux 3 Ebenen	DESGLOSE BREAKDOWN COMPOSITION AUFLISTUNG	REF. 4 niveles 4 levels 4 niveaux 4 Ebenen	DESGLOSE BREAKDOWN COMPOSITION AUFLISTUNG	REF. 5 niveles 5 levels 5 niveaux 5 Ebenen	DESGLOSE BREAKDOWN COMPOSITION AUFLISTUNG
P7141	2 S1 + 3 T6	P7188	2 S2 + 4 T6	P7235	2 S3 + 5 T6
P7142	2 S1 + 3 T7	P7189	2 S2 + 4 T7	P7236	2 S3 + 5 T7
P7143	2 S1 + 3 T8	P7190	2 S2 + 4 T8	P7237	2 S3 + 5 T8
P7144	2 S1 + 3 T9	P7191	2 S2 + 4 T9	P7238	2 S3 + 5 T9
P7145	2 S1 + 3 T10	P7192	2 S2 + 4 T10	P7239	2 S3 + 5 T10
P7146	2 S1 + 3 T11	P7193	2 S2 + 4 T11	P7240	2 S3 + 5 T11
P7147	2 S1 + 3 T13	P7194	2 S2 + 4 T13	P7241	2 S3 + 5 T13
P7148	2 S1 + 3 T14	P7195	2 S2 + 4 T14	P7242	2 S3 + 5 T14
P7149	2 S1 + 3 T15	P7196	2 S2 + 4 T15	P7243	2 S3 + 5 T15
P7150	2 S1 + 3 T16	P7197	2 S2 + 4 T16	P7244	2 S3 + 5 T16
P7151	3 S1 + 6 T8	P7198	3 S2 + 8 T8	P7245	3 S3 + 10 T8
P7152	3 S1 + 3 T8 + 3 T9	P7199	3 S2 + 4 T8 + 4 T9	P7246	3 S3 + 5 T8 + 5 T9
P7153	3 S1 + 6 T9	P7200	3 S2 + 8 T9	P7247	3 S3 + 10 T9
P7154	3 S1 + 3 T9 + 3 T10	P7201	3 S2 + 4 T9 + 4 T10	P7248	3 S3 + 5 T9 + 5 T10
P7155	3 S1 + 6 T10	P7202	3 S2 + 8 T10	P7249	3 S3 + 10 T10
P7156	3 S1 + 3 T10 + 3 T11	P7203	3 S2 + 4 T10 + 4 T11	P7250	3 S3 + 5 T10 + 5 T11
P7157	3 S1 + 6 T11	P7204	3 S2 + 8 T11	P7251	3 S3 + 10 T11
P7158	3 S1 + 3 T11 + 3 T13	P7205	3 S2 + 4 T11 + 4 T13	P7252	3 S3 + 5 T11 + 5 T13
P7159	3 S1 + 6 T13	P7206	3 S2 + 8 T13	P7253	3 S3 + 10 T13
P7160	3 S1 + 3 T13 + 3 T14	P7207	3 S2 + 4 T13 + 4 T14	P7254	3 S3 + 5 T13 + 5 T14
P7161	3 S1 + 6 T14	P7208	3 S2 + 8 T14	P7255	3 S3 + 10 T14
P7162	3 S1 + 3 T14 + 3 T15	P7209	3 S2 + 4 T14 + 4 T15	P7256	3 S3 + 5 T14 + 5 T15
P7163	3 S1 + 6 T15	P7210	3 S2 + 8 T15	P7257	3 S3 + 10 T15
P7164	3 S1 + 3 T15 + 3 T16	P7211	3 S2 + 4 T15 + 4 T16	P7258	3 S3 + 5 T15 + 5 T16
P7165	3 S1 + 6 T16	P7212	3 S2 + 8 T16	P7259	3 S3 + 10 T16
P7166	4 S1 + 6 T10 + 3 T11	P7213	4 S2 + 8 T10 + 4 T11	P7260	4 S3 + 10 T10 + 5 T11
P7167	4 S1 + 3 T10 + 6 T11	P7214	4 S2 + 4 T10 + 8 T11	P7261	4 S3 + 5 T10 + 10 T11
P7168	4 S1 + 9 T11	P7215	4 S2 + 12 T11	P7262	4 S3 + 15 T11
P7169	4 S1 + 6 T11 + 3 T13	P7216	4 S2 + 8 T11 + 4 T13	P7263	4 S3 + 10 T11 + 5 T13
P7170	4 S1 + 3 T11 + 6 T13	P7217	4 S2 + 4 T11 + 8 T13	P7264	4 S3 + 5 T11 + 10 T13
P7171	4 S1 + 9 T13	P7218	4 S2 + 12 T13	P7265	4 S3 + 15 T13
P7172	4 S1 + 6 T13 + 3 T14	P7219	4 S2 + 8 T13 + 4 T14	P7266	4 S3 + 10 T13 + 5 T14
P7173	4 S1 + 3 T13 + 6 T14	P7220	4 S2 + 4 T13 + 8 T14	P7267	4 S3 + 5 T13 + 10 T14
P7174	4 S1 + 9 T14	P7221	4 S2 + 12 T14	P7268	4 S3 + 15 T14
P7175	4 S1 + 6 T14 + 3 T15	P7222	4 S2 + 8 T14 + 4 T15	P7269	4 S3 + 10 T14 + 5 T15
P7176	4 S1 + 3 T14 + 6 T15	P7223	4 S2 + 4 T14 + 8 T15	P7270	4 S3 + 5 T14 + 10 T15
P7177	4 S1 + 9 T15	P7224	4 S2 + 12 T15	P7271	4 S3 + 15 T15
P7178	4 S1 + 6 T15 + 3 T16	P7225	4 S2 + 8 T15 + 4 T16	P7272	4 S3 + 10 T15 + 5 T16
P7179	4 S1 + 3 T15 + 6 T16	P7226	4 S2 + 4 T15 + 8 T16	P7273	4 S3 + 5 T15 + 10 T16
P7180	4 S1 + 9 T16	P7227	4 S2 + 12 T16	P7274	4 S3 + 15 T16
P7181	5 S1 + 6 T11 + 6 T13	P7228	5 S2 + 8 T11 + 8 T13	P7275	5 S3 + 10 T11 + 10 T13
P7182	5 S1 + 3 T11 + 9 T13	P7229	5 S2 + 4 T11 + 12 T13	P7276	5 S3 + 5 T11 + 15 T13
P7183	5 S1 + 12 T13	P7230	5 S2 + 16 T13	P7277	5 S3 + 20 T13
P7184	5 S1 + 3 T14 + 9 T13	P7231	5 S2 + 4 T14 + 12 T13	P7278	5 S3 + 5 T14 + 15 T13
P7185	5 S1 + 6 T13 + 6 T14	P7232	5 S2 + 8 T13 + 8 T14	P7279	5 S3 + 10 T13 + 10 T14
P7186	5 S1 + 3 T13 + 9 T14	P7233	5 S2 + 4 T13 + 12 T14	P7280	5 S3 + 5 T13 + 15 T14
P7187	5 S1 + 12 T14	P7234	5 S2 + 16 T14	P7281	5 S3 + 20 T14

FONDO 385 mm. Adaptable a GASTRONORM 2/3 / DEEPTH 385 mm. Suitable for 2/3 GASTRONORM /
PROFONDEUR 385 mm. Adaptable aux GASTRONORME 2/3 / Tiefe 385 mm. Passend für Gastronorm 2/3

REF. 3 niveles 3 levels 3 niveaux 3 Ebenen	DESGLOSE BREAKDOWN COMPOSITION AUFLISTUNG
P7282	1 S7 + 3 T61
P7283	1 S7 + 3 T71
P7284	1 S7 + 3 T81
P7285	1 S7 + 3 T91
P7286	1 S7 + 3 T101
P7287	1 S7 + 3 T111
P7288	1 S7 + 3 T131
P7289	1 S7 + 3 T141
P7290	1 S7 + 3 T151
P7291	1 S7 + 3 T161
P7292	2 S7 + 6 T81
P7293	2 S7 + 3 T81 + 3 T91
P7294	2 S7 + 6 T91
P7295	2 S7 + 3 T91 + 3 T101
P7296	2 S7 + 6 T101
P7297	2 S7 + 3 T111 + 3 T111
P7298	2 S7 + 6 T111
P7299	2 S7 + 3 T111 + 3 T131
P7300	2 S7 + 6 T131
P7301	2 S7 + 3 T131 + 3 T141
P7302	2 S7 + 6 T141
P7303	2 S7 + 3 T141 + 3 T151
P7304	2 S7 + 6 T151
P7305	2 S7 + 3 T151 + 3 T161
P7306	2 S7 + 6 T161
P7307	3 S7 + 6 T101 + 3 T111
P7308	3 S7 + 3 T101 + 6 T111
P7309	3 S7 + 9 T111
P7310	3 S7 + 6 T111 + 3 T131
P7311	3 S7 + 3 T111 + 6 T131
P7312	3 S7 + 9 T131
P7313	3 S7 + 6 T131 + 3 T141
P7314	3 S7 + 3 T131 + 6 T141
P7315	3 S7 + 9 T141
P7316	3 S7 + 6 T141 + 3 T151
P7317	3 S7 + 3 T141 + 6 T151
P7318	3 S7 + 9 T151
P7319	3 S7 + 6 T151 + 3 T161
P7320	3 S7 + 3 T151 + 6 T161
P7321	3 S7 + 9 T161
P7322	4 S7 + 6 T111 + 6 T131
P7323	4 S7 + 3 T111 + 9 T131
P7324	4 S7 + 12 T131
P7325	4 S7 + 3 T141 + 9 T131
P7326	4 S7 + 6 T131 + 6 T141
P7327	4 S7 + 3 T131 + 9 T141
P7328	4 S7 + 12 T141

REF. 4 niveles 4 levels 4 niveaux 4 Ebenen	DESGLOSE BREAKDOWN COMPOSITION AUFLISTUNG
P7329	1 S8 + 4 T61
P7330	1 S8 + 4 T71
P7331	1 S8 + 4 T81
P7332	1 S8 + 4 T91
P7333	1 S8 + 4 T101
P7334	1 S8 + 4 T111
P7335	1 S8 + 4 T131
P7336	1 S8 + 4 T141
P7337	1 S8 + 4 T151
P7338	1 S8 + 4 T161
P7339	2 S8 + 8 T81
P7340	2 S8 + 4 T81 + 4 T91
P7341	2 S8 + 8 T91
P7342	2 S8 + 4 T91 + 4 T101
P7343	2 S8 + 8 T101
P7344	2 S8 + 4 T101 + 4 T111
P7345	2 S8 + 8 T111
P7346	2 S8 + 4 T111 + 4 T131
P7347	2 S8 + 8 T131
P7348	2 S8 + 4 T131 + 4 T141
P7349	2 S8 + 8 T141
P7350	2 S8 + 4 T141 + 4 T151
P7351	2 S8 + 6 T151
P7352	2 S8 + 4 T151 + 4 T161
P7353	2 S8 + 8 T161
P7354	3 S8 + 8 T101 + 4 T111
P7355	3 S8 + 4 T101 + 8 T111
P7356	3 S8 + 12 T111
P7357	3 S8 + 8 T111 + 4 T131
P7358	3 S8 + 4 T111 + 8 T131
P7359	3 S8 + 12 T131
P7360	3 S8 + 8 T131 + 4 T141
P7361	3 S8 + 4 T131 + 8 T141
P7362	3 S8 + 12 T141
P7363	3 S8 + 8 T141 + 4 T151
P7364	3 S8 + 4 T141 + 8 T151
P7365	3 S8 + 12 T151
P7366	3 S8 + 8 T151 + 4 T161
P7367	3 S8 + 4 T151 + 8 T161
P7368	3 S8 + 12 T161
P7369	4 S8 + 8 T111 + 8 T131
P7370	4 S8 + 4 T111 + 12 T131
P7371	4 S8 + 16 T131
P7372	4 S8 + 4 T141 + 12 T131
P7373	4 S8 + 8 T131 + 8 T141
P7374	4 S8 + 4 T131 + 12 T141
P7375	4 S8 + 16 T141

REF. 5 niveles 5 levels 5 niveaux 5 Ebenen	DESGLOSE BREAKDOWN COMPOSITION AUFLISTUNG
P7376	1 S9 + 5 T61
P7377	1 S9 + 5 T71
P7378	1 S9 + 5 T81
P7379	1 S9 + 5 T91
P7380	1 S9 + 5 T101
P7381	1 S9 + 5 T111
P7382	1 S9 + 5 T131
P7383	1 S9 + 5 T141
P7384	1 S9 + 5 T151
P7385	1 S9 + 5 T161
P7386	2 S9 + 10 T81
P7387	2 S9 + 5 T81 + 5 T91
P7388	2 S9 + 10 T91
P7389	2 S9 + 5 T91 + 5 T101
P7390	2 S9 + 10 T101
P7391	2 S9 + 5 T101 + 5 T111
P7392	2 S9 + 10 T111
P7393	2 S9 + 5 T111 + 5 T131
P7394	2 S9 + 10 T131
P7395	2 S9 + 5 T131 + 5 T141
P7396	2 S9 + 10 T141
P7397	2 S9 + 5 T141 + 5 T151
P7398	2 S9 + 10 T151
P7399	2 S9 + 5 T151 + 5 T161
P7400	2 S9 + 10 T161
P7401	3 S9 + 10 T101 + 5 T111
P7402	3 S9 + 5 T101 + 10 T111
P7403	3 S9 + 15 T111
P7404	3 S9 + 10 T111 + 5 T131
P7405	3 S9 + 5 T111 + 10 T131
P7406	3 S9 + 15 T131
P7407	3 S9 + 10 T131 + 5 T141
P7408	3 S9 + 5 T131 + 10 T141
P7409	3 S9 + 15 T141
P7410	3 S9 + 10 T141 + 5 T151
P7411	3 S9 + 5 T141 + 10 T151
P7412	3 S9 + 15 T151
P7413	3 S9 + 10 T151 + 5 T161
P7414	3 S9 + 5 T151 + 10 T161
P7415	3 S9 + 15 T161
P7416	4 S9 + 10 T111 + 10 T131
P7417	4 S9 + 5 T111 + 15 T131
P7418	4 S9 + 20 T131
P7419	4 S9 + 5 T141 + 15 T131
P7420	4 S9 + 10 T131 + 10 T141
P7421	4 S9 + 5 T131 + 15 T141
P7422	4 S9 + 20 T141

FONDO 555 mm. Adaptable a GASTRONORM 1/1 / DEPTH 555 mm. Suitable for 1/1 GASTRONORM /
PROFONDEUR 555 mm. Adaptable aux GASTRONORME 1/1 / Tiefe 555 mm. Passend für Gastronorm 1/1

REF. 3 niveles 3 levels 3 niveaux 3 Ebenen	DESGLOSE BREAKDOWN COMPOSITION AUFLISTUNG	REF. 4 niveles 4 levels 4 niveaux 4 Ebenen	DESGLOSE BREAKDOWN COMPOSITION AUFLISTUNG	REF. 5 niveles 5 levels 5 niveaux 5 Ebenen	DESGLOSE BREAKDOWN COMPOSITION AUFLISTUNG
P7423	1 S1 + 3 T6	P7470	1 S2 + 4 T6	P7517	1 S3 + 5 T6
P7424	1 S1 + 3 T7	P7471	1 S2 + 4 T7	P7518	1 S3 + 5 T7
P7425	1 S1 + 3 T8	P7472	1 S2 + 4 T8	P7519	1 S3 + 5 T8
P7426	1 S1 + 3 T9	P7473	1 S2 + 4 T9	P7520	1 S3 + 5 T9
P7427	1 S1 + 3 T10	P7474	1 S2 + 4 T10	P7521	1 S3 + 5 T10
P7428	1 S1 + 3 T11	P7475	1 S2 + 4 T11	P7522	1 S3 + 5 T11
P7429	1 S1 + 3 T13	P7476	1 S2 + 4 T13	P7523	1 S3 + 5 T13
P7430	1 S1 + 3 T14	P7477	1 S2 + 4 T14	P7524	1 S3 + 5 T14
P7431	1 S1 + 3 T15	P7478	1 S2 + 4 T15	P7525	1 S3 + 5 T15
P7432	1 S1 + 3 T16	P7479	1 S2 + 4 T16	P7526	1 S3 + 5 T16
P7433	2 S1 + 6 T8	P7480	2 S2 + 8 T8	P7527	2 S3 + 10 T8
P7434	2 S1 + 3 T8 + 3 T9	P7481	2 S2 + 4 T8 + 4 T9	P7528	2 S3 + 5 T8 + 5 T9
P7435	2 S1 + 6 T9	P7482	2 S2 + 8 T9	P7529	2 S3 + 10 T9
P7436	2 S1 + 3 T9 + 3 T10	P7483	2 S2 + 4 T9 + 4 T10	P7530	2 S3 + 5 T9 + 5 T10
P7437	2 S1 + 6 T10	P7484	2 S2 + 8 T10	P7531	2 S3 + 10 T10
P7438	2 S1 + 3 T10 + 3 T11	P7485	2 S2 + 4 T10 + 4 T11	P7532	2 S3 + 5 T10 + 5 T11
P7439	2 S1 + 6 T11	P7486	2 S2 + 8 T11	P7533	2 S3 + 10 T11
P7440	2 S1 + 3 T11 + 3 T13	P7487	2 S2 + 4 T11 + 4 T13	P7534	2 S3 + 5 T11 + 5 T13
P7441	2 S1 + 6 T13	P7488	2 S2 + 8 T13	P7535	2 S3 + 10 T13
P7442	2 S1 + 3 T13 + 3 T14	P7489	2 S2 + 4 T13 + 4 T14	P7536	2 S3 + 5 T13 + 5 T14
P7443	2 S1 + 6 T14	P7490	2 S2 + 8 T14	P7537	2 S3 + 10 T14
P7444	2 S1 + 3 T14 + 3 T15	P7491	2 S2 + 4 T14 + 4 T15	P7538	2 S3 + 5 T14 + 5 T15
P7445	2 S1 + 6 T15	P7492	2 S2 + 8 T15	P7539	2 S3 + 10 T15
P7446	2 S1 + 3 T15 + 3 T16	P7493	2 S2 + 4 T15 + 4 T16	P7540	2 S3 + 5 T15 + 5 T16
P7447	2 S1 + 6 T16	P7494	2 S2 + 8 T16	P7541	2 S3 + 10 T16
P7448	3 S1 + 6 T10 + 3 T11	P7495	3 S2 + 8 T10 + 4 T11	P7542	3 S3 + 10 T10 + 5 T11
P7449	3 S1 + 3 T10 + 6 T11	P7496	3 S2 + 4 T10 + 8 T11	P7543	3 S3 + 5 T10 + 10 T11
P7450	3 S1 + 9 T11	P7497	3 S2 + 12 T11	P7544	3 S3 + 15 T11
P7451	3 S1 + 6 T11 + 3 T13	P7498	3 S2 + 8 T11 + 4 T13	P7545	3 S3 + 10 T11 + 5 T13
P7452	3 S1 + 3 T11 + 6 T13	P7499	3 S2 + 4 T11 + 8 T13	P7546	3 S3 + 5 T11 + 10 T13
P7453	3 S1 + 9 T13	P7500	3 S2 + 12 T13	P7547	3 S3 + 15 T13
P7454	3 S1 + 6 T13 + 3 T14	P7501	3 S2 + 8 T13 + 4 T14	P7548	3 S3 + 10 T13 + 5 T14
P7455	3 S1 + 3 T13 + 6 T14	P7502	3 S2 + 4 T13 + 8 T14	P7549	3 S3 + 5 T13 + 10 T14
P7456	3 S1 + 9 T14	P7503	3 S2 + 12 T14	P7550	3 S3 + 15 T14
P7457	3 S1 + 6 T14 + 3 T15	P7504	3 S2 + 8 T14 + 4 T15	P7551	3 S3 + 10 T14 + 5 T15
P7458	3 S1 + 3 T14 + 6 T15	P7505	3 S2 + 4 T14 + 8 T15	P7552	3 S3 + 5 T14 + 10 T15
P7459	3 S1 + 9 T15	P7506	3 S2 + 12 T15	P7553	3 S3 + 15 T15
P7460	3 S1 + 6 T15 + 3 T16	P7507	3 S2 + 8 T15 + 4 T16	P7554	3 S3 + 10 T15 + 5 T16
P7461	3 S1 + 3 T15 + 6 T16	P7508	3 S2 + 4 T15 + 8 T16	P7555	3 S3 + 5 T15 + 10 T16
P7462	3 S1 + 9 T16	P7509	3 S2 + 12 T16	P7556	3 S3 + 15 T16
P7463	4 S1 + 6 T11 + 6 T13	P7510	4 S2 + 8 T11 + 8 T13	P7557	4 S3 + 10 T11 + 10 T13
P7464	4 S1 + 3 T11 + 9 T13	P7511	4 S2 + 4 T11 + 12 T13	P7558	4 S3 + 5 T11 + 15 T13
P7465	4 S1 + 12 T13	P7512	4 S2 + 16 T13	P7559	4 S3 + 20 T13
P7466	4 S1 + 3 T14 + 9 T13	P7513	4 S2 + 4 T14 + 12 T13	P7560	4 S3 + 5 T14 + 15 T13
P7467	4 S1 + 6 T13 + 6 T14	P7514	4 S2 + 8 T13 + 8 T14	P7561	4 S3 + 10 T13 + 10 T14
P7468	4 S1 + 3 T13 + 9 T14	P7515	4 S2 + 4 T13 + 12 T14	P7562	4 S3 + 5 T13 + 15 T14
P7469	4 S1 + 12 T14	P7516	4 S2 + 16 T14	P7563	4 S3 + 20 T14



Sweet Series

Scale

Sweet Series

Sweet Series

**HELADERÍA Y PASTELERÍA /
ICE-CREAM UTENSILS & PASTRY /
USTENSILES À GLACE ET PÂTISSERIE /
ZUBEHÖR FÜR EISCREME UND PATISSERIE**

9.1	HELADERÍA / ICE-CREAM UTENSILS / USTENSILES POUR GLACE/ ZUBEHÖR FÜR EISCREME	238
9.2	UTENSILIOS DE PASTELERÍA / PASTRY UTENSILS / USTENSILES DE PÂTISSERIE / PATISSERIEZUBEHÖR	242
9.3	MOLDES ANTIADHERENTES / NON-STICK MOULDS / MOULES ANTI-ADHÉSIFS / ANTIHAFT BACKFORMEN	255
9.4	CORTAPASTAS / PASTRY CUTTER / DÉCOUPOIRS / TEIGSCHNEIDER	259
9.5	MOLDES ACERO INOXIDABLE / ST/STEEL PASTRY MOULDS / MOULES EN ACIER INOX / BACKFORMEN ROSTFREIER STAHL	260
9.6	MANGAS Y BOQUILLAS / BAGS AND TUBES / POCHES ET DOUILLES / SPRITZBEUTEL UND TÜLLEN	263
9.7	MOLDES SILICONA / SILICONE MOULDS / MOULES SILICONE / SILIKONBACKFORMEN	269
9.8	MOLDES FLEXIPAN / FLEXIPAN MOULDS / MOULES FLEXIPAN / FLEXIPANBACKFORMEN	274

9.1 HELADERÍA / ICE-CREAM UTENSILS / UTENSILES POUR GLACE / ZUBEHÖR FÜR EISCREME



47274 Racionador helado / Ice cream scoop / Cuillère à glace / Eiskungelportionierer



REF	COLOR	TAMAÑO / SIZE	BOL cm	L cm	Mlts	
47274	●	8	5,4	19,5	118,3	12
47275	●	10	5,2	19,5	88,7	12
47276	●	12	4,8	19,5	73,9	12
47277	●	16	4,4	19,0	59,1	12
47278	●	20	4,1	19,5	44,4	12
47279	●	24	3,7	19,0	29,6	12



47169 Racionador ovalado / Oval squeeze disher / Doseur à presser oval / Ovale Eisportionierer



REF	TAMAÑO / SIZE	cm	Mlts	
47169	14	7 x 5,5	68	10
47170	20	6,3 x 4,8	46	10
47171	24	5,8 x 4,6	38	10
47172	30	5,3 x 4,1	28	10
47200	40	5 x 3,6	22,2	10

47150 Racionador helado / Round Squeeze Disher / Doseur à presser ronde / Runde Eisportionierer



REF	TAMAÑO / SIZE	Ø cm	L cm	Mlts	
T7206	6	7,90	23,2	157,6	12
47150	8	6,70	23,2	118,3	12
47151	10	6,50	22,5	92,4	12
47152	12	6,20	22,5	81,3	12
47153	16	5,60	21,6	59,1	12
47154	20	5,20	21,6	44,4	12
47155	24	4,90	21,0	40,7	12
47156	30	4,80	21,0	37,0	12
47157	40	4,10	20,3	25,9	12
47158	50	3,80	20,0	18,5	12
47159	60	3,50	19,7	16,6	12
47160	70	3,30	19,7	14,3	12
47161	100	2,90	19,1	11,1	12

P331 Racionador de helado / Ice cream scoop / Cuillère à glace / Eiskugelportionierer



REF	Ø mm	Mlts	
P331.039	39	15	12
P331.044	44	22	12
P331.050	50	32	12
P331.056	56	46	12
P331.059	59	54	12
P331.066	66	75	12
P331.070	70	90	12

P908 Racionador de helado / Ice cream scoop / Cuillère à glace / Eiskugelportionierer



INOX - ST/STEEL
EDELSTAHL

*METACRILATO / METHACRYLATE /
MÉTHACRYLATE / METAALKRYLAT

REF	COLOR / COLOUR / COULEUR FARBE	L cm	
P908.000	Blanca / White / Blanc / Weiss	26	1
P908.001*	Transparente / Clear / Trasparente / Transparent	26	1
P908.002	Roja / Red / Rouge / Rot	26	1
P908.003	Azul / Blue / Bleu / Blau	26	1
P908.004	Amarilla / Yellow / Jaune / Gelb	26	1

P332 Copa helado / Ice cream cup / Coupe à glace / Eisschale



P332.010

P332.095

REF	Ø cm	H cm	Lts	
P332.095	9,5	8,5	0,15	1
P332.010	10,5	6,0	0,17	12

P875 Soporte para cucuruchos / Cornet stand / Support pour cornets / Eiswaffelständer

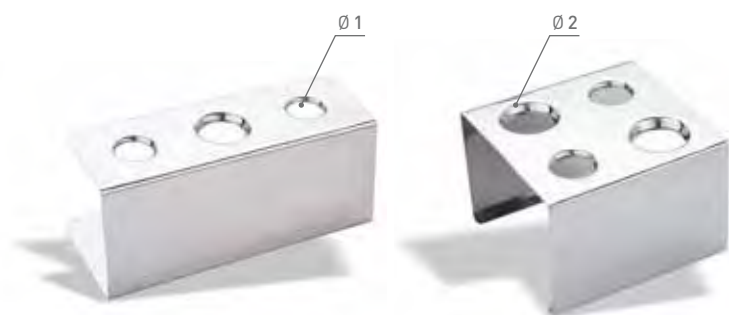

Ref. P875.003

Ref. P875.004

REF	Ø cm	
P875.003	21 x 7 x 8,5	1
P875.004	12 x 12 x 7,5	1

Ø 1 25 mm
Ø 2 32 mm

P914 360 x 165 mmINOX - ST/STEEL
EDELSTAHL
18/10

REF	mm	H mm	Lts	
P914.080	360 x 165	80	3,4	10
P914.120	360 x 165	120	5	10
P914.150	360 x 165	150	7	10

P915 360 x 250 mmINOX - ST/STEEL
EDELSTAHL
18/10

REF	mm	H mm	Lts	
P915.080	360 x 250	80	5,4	10

P9161 360 x 165 mmPolicarbonato.
Polycarbonate.
Polycarbonate.
Polycarbonat.

REF	mm	H mm	Lts	
P916.120	360 x 165	120	5	10

P917 360 x 250 mmPolicarbonato.
Polycarbonate.
Polycarbonate.
Polycarbonat.

REF	mm	H mm	Lts	
P917.080	360 x 250	80	3,4	10

P9160 Tapa policarbonato /
Polycarbonate lid /
Couvercle en polycarbonate /
Deckel PolycarbonatAdaptable a cubetas heladería inox y policarbonato.
Adjustable for St/Steel Ice cream containers.
Adaptable aux récipient à glace en acier inox.
Passend für Eisbehälter Edelstahl und Polycarbonat.

REF	mm	
P916.000	360 x 165	10

P918 Lava - racionador acero inoxidable /
St/steel scoop - washer /
Rince - cuillères acier inoxydable /
Eisportioniererspüle rostfreier Stahl

REF	mm	
P918.000	375 x 195 x 270	1

SOLUCIONES PARA LA HELADERÍA /

ICE-CREAM AND BEVERAGE SOLUTIONS

P. 344



HELADO SOFT Y YOGUR HELADO /
SOFT SERVE & FROZEN YOGURT EQUIPMENT /
GLACE À L'ITALIENNE ET YAOURT GLACÉ /
SOFTAEIS UND FROZEN YOGURT



BEBIDAS FRÍAS Y GRANIZADOS /
COLD & FROZEN BEVERAGE /
BOISSONS FROIDES ET GRANITÉS /
KALTGETRÄNKE UND SLUSH EIS



HELADO CUSTARD Y CREMAS HELADAS /
FROZEN CUSTARD AND DAIRY ICE-CREAM /
GLACES CUSTARD ET CRÉMES GLACÉES /
CREMEEIS UND EISCREMES



ACCESORIOS /
ACCESSORIES /
ACCESSOIRES /
ZUBEHÖR



PASTELERÍA / PASTRY / PÂTISSERIE / PATISSERIE

ESPAÑOL

PUJADAS ofrece en esta sección los ESENCIALES de la pastelería, todos ellos fabricados en materiales de máxima calidad para ser utilizados de una forma intensiva.

También se presentan multitud de ARTÍCULOS COMPLEMENTARIOS propios del oficio de la pastelería para que el profesional repostero pueda realizar sus labores creativas en las mejores condiciones.

FRANÇAIS

PUJADAS propose un large éventail de MOULES, CERCLES et FORMES TRÈS ROBUSTES, fabriqués AVEC DIFFÉRENTS matériaux d'une qualité maximale pour permettre au professionnel de réaliser des créations de pâtisserie les plus sophistiquées.

PUJADAS propose également de nombreux ARTICLES COMPLEMENTAIRES particuliers à la pâtisserie pour permettre au pâtissier de mener à terme ses tâches de création dans les meilleures conditions possibles

ENGLISH

PUJADAS offers an extensive array of extremely resistant MOULDS, RINGS AND FORMS in various materials of the highest quality. Ideally suited for professionals devoted to the creation of their most sophisticated works of art.

A large number of ANCILLARY ITEMS are also introduced to enable professional pastry cooks and confectioners to carry out their creative work in the best possible conditions.

DEUTSCH

Pujadas bietet eine grosse Anzahl von Schablonen, Ringen und Formen von aussergewöhnlicher Festigkeit aus verschiedenen Materialien höchster Qualität an. Ideal für jeden Profi, der die höchstentwickelten Nachspeisen kreieren möchte.

Auch präsentieren Wir Ihnen Eine Vielzahl von Konditoreieigenen zubehörArtikeln, mit denen der professionelle Konditor seine kreativsten Arbeiten unter den besten Bedingungen realisieren kann.



P304 Cazo bombeado / Conical saucepan / Casserole bombée / Kugelförmige Stielkasserole

INOX - ST/STEEL
 EDELSTAHL
 18/10



REF	Ø cm	H cm	Lts	
P304.016	16	7,5	1,00	1
P304.018	18	8,0	1,70	1
P304.020	20	10,0	2,50	1
P304.022	22	11,5	3,70	1
P304.024	24	12,0	4,50	1

P3070 Caldero fondo plano / Boiler / Bassine à fond plat / Kessel ebener Boden

INOX - ST/STEEL
 EDELSTAHL
 18/10



REF	Ø cm	H cm	Lts	
P307.020	20	10,5	2,20	1
P307.025	25	11,5	3,50	1
P307.030	30	14,0	6,00	1
P307.035	35	14,5	8,50	1
P307.040	40	16,5	13,00	1
P307.045	45	17,5	20,00	1
P307.050	50	20,0	25,00	1
P307.060	60	22,5	45,00	1
P307.070	70	24,5	65,00	1

P3071 Caldero fondo bombeado / Conical boiler / Bassine à fond bombé / Kessel kugelförmiger Boden

INOX - ST/STEEL
 EDELSTAHL
 18/10



REF	Ø cm	H cm	Lts	
P307.125	25	13,0	3,80	1
P307.130	30	16,0	6,50	1
P307.140	40	19,0	13,00	1
P307.150	50	23,5	25,00	1

P306 Caldero timbal / Mixing boiler / Bol mixeur / Rührschüssel

INOX - ST/STEEL
 EDELSTAHL
 18/10



REF	Ø cm	H cm	Lts	
P306.035	35	18,0	10,00	1

9.2 UTENSILIOS DE PASTELERÍA / PASTRY UTENSILS / USTENSILES DE PÂTISSERIE / PATISSERIEZUBEHÖR

P356 Fuente honda cónica / Kitchen bowl / Bassine pâtissière / Rührschüssel

INOX - ST/STEEL
EDELSTAHL
18/10



Medidas exteriores / Outer sizes /
Dimensions extérieures / Aussenmasse

REF	Ø cm	H cm	Lts	
P356.016	16	5,5	0,65	1
P356.020	20	7,5	1,30	1
P356.024	24	8,5	2,10	1
P356.028	28	11,0	3,70	1
P356.032	32	12,5	6,00	1

Bol inox. semi-esférico / Stainless Steel mixing bowl / Bassine inox demi-ronde / Edelstahlschüssel halbrund

479



REF	Ø cm	Lts	
47933	24	2,80	12
47934	28	3,80	12
47935	30	4,70	12
47938	35	7,60	6
47943	40	12,00	6

P764 Molde semiesférico / Hemispherical mould / Demi-sphérique / Halbkugelform

INOX - ST/STEEL
EDELSTAHL
18/10



REF	Ø cm	H cm	Lts	
P764.008	8	4,0	0,130	1
P764.010	10	5,0	0,260	1
P764.012	12	6,2	0,450	1
P764.014	14	6,7	0,700	1

P951 Librador de acero inox / St/steel scoop / Pelle à farine en acier inox / Mehlschaufel rostfreier Stahl

INOX - ST/STEEL
EDELSTAHL
18/10



REF	L cm	Lts	
P951.010	10	0,10	5
P951.015	15	0,40	5
P951.019	19	1,00	5
P951.024	24	1,70	5

P953 Librador aluminio / Aluminium scoop / Pelle à farine aluminium / Mehlschaufel Aluminium

ALUMINIO /
ALUMINIUM



REF	L cm	Lts	
P953.001	11	0,15	12
P953.002	15	0,35	12
P953.003	18,5	0,71	12
P953.004	21,5	1,10	12
P953.005	25,5	1,71	12

P952 Librador policarbonato / Polycarbonate scoop / Pelle à farine polycarbonate / Mehlschaufel Polycarbonat

ALUMINIO /
ALUMINIUM

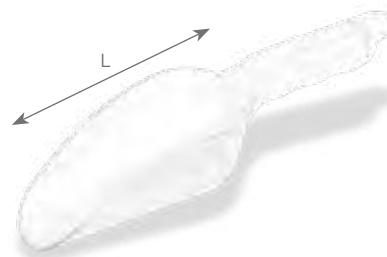

REF	L cm	Lts	
P952.001	13	0,17	12
P952.002	15,5	0,35	12
P952.003	17,5	0,71	12

**P316 Batidor (12 varillas) / Whisk (12 wires) /
Fouet (12 fils) / Rührbesen (12 Drähte)**

Grueso varilla / Wire thickness /
Epaisseur des fils / Drahtdicke :
1,3 mm



REF	L cm	
P316.025	25	12
P316.030	30	12
P316.035	35	12
P316.040	40	12
P316.045	45	12
P316.050	50	12

**P3161 Batidor (10 varillas) / Whisk (10 wires) /
Fouet (10 fils) / Rührbesen (10 Drähte)**

Grueso varilla / Wire thickness /
Epaisseur des fils / Drahtdicke:
1,8 mm



REF	L cm	
P316.125	25	12
P316.130	30	12
P316.135	35	12
P316.140	40	12
P316.145	45	12
P316.150	50	12

**P354 Batidor grueso (8 varillas) / Heavy whisk (8 wires) /
Fouet épais (8 fils) / Rührbesen (8 Drähte)**

Grueso varilla / Wire thickness /
Epaisseur des fils / Drahtdicke:
2,4 mm

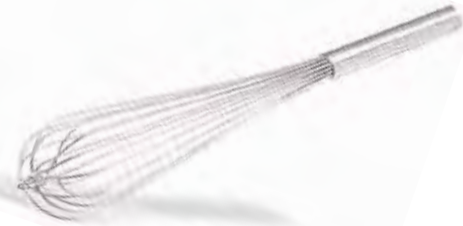

REF	L cm	
P354.025	25	12
P354.030	30	12
P354.035	35	12
P354.040	40	12
P354.045	45	12
P354.050	50	12

**P959 Batidor mango abs antideslizante (8 varillas) /
Whisk with anti-slip abs handle (8 wires) /
Fouet avec poignée abs anti-crispation (8 fils) /
Rührbesen Antirutschgriff ABS (7 Drähte)**

Grueso varilla / Wire thickness /
Epaisseur des fils / Drahtdicke:
2 mm



REF	L cm	
P959.025	25	12
P959.030	30	12
P959.035	35	12
P959.040	40	12
P959.045	45	12
P959.050	50	12

**P393 Batidor gigante / Big whisk /
Fouet à purée / Grosser Rührbesen**

Grueso varilla / Wire thickness /
Epaisseur des fils / Drahtdicke:
3 mm

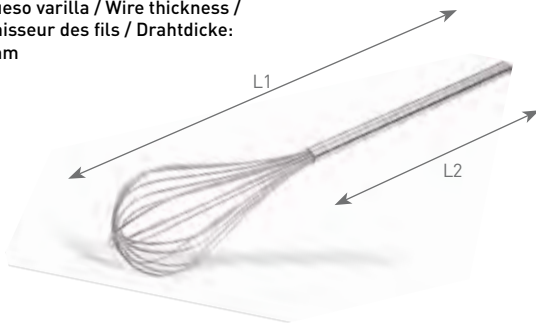

REF	L1 cm	L2 cm	
P393.080	80	45	1
P393.100	100	65	1
P393.125	125	90	1

VER PRODUCTOS EN / SEE PRODUCTS ON /
VOIR PRODUITS EN PAGE / SIEHE PRODUKTE IN

**Bandeja pastelería /
Baking sheet /
Plaque à pâtisserie /
Patisserietablett**



P. 72

9.2 UTENSILIOS DE PASTELERÍA / PASTRY UTENSILS / USTENSILES DE PÂTISSERIE / PATISSERIEZUBEHÖR

P398 Espátula de goma / Rubber spatula / Spatule en caoutchouc / Gummispachtel



REF	L cm	
P398.024	25,5	24
P398.035	33,0	12
P398.042	41,0	12

Mango ergonómico. Goma aceptada para uso alimentario. Puede lavarse en el lavavajillas. Moldeado especial que previene la separación de la goma del mango. Anatomical handle. Suitable rubber for food contact. Safe dishwasher. Special mould that prevents the rubber to come off from the handle. Manche anatomique. Caoutchouc conforme au contact alimentaire. Utilisable au lave-vaisselle. Moulage spécial pour éviter la séparation de la gomme du manche. Ergonomischer Griff. Gummi geeignet für die Lebensmittelverarbeitung. Spülmachinenfest. Spezieller Rahmen, der das Trennen von Gummi und Stiel vorsieht.

P398290 Espátula estrecha goma / Narrow rubber spatula / Spatule étroite en caoutchouc / Gerade Gummispachtel

IDEA!

Perfecta para vaciar tarros /
Perfect to empty small jars /
Parfait pour vider des petits pots /
Perfekt für das Leeren von
schmalen Behältern

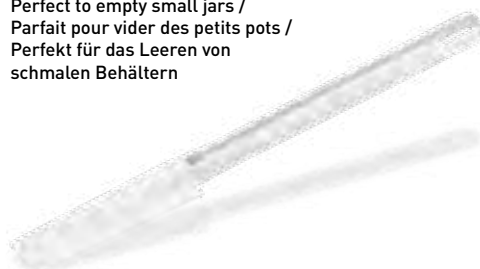

REF	PALA / PEEL / PELLE / SCHAUFEL cm	L cm	
P398.290	8,8 x 3,3	25,5	24

P3981 Espátula silicona alta temperatura / High heat silicone spatula. Bowl scraper / Spatule silicone haute température / Silikonspachtel hohe Temperaturen



REF	PALA / PEEL / PELLE / SCHAUFEL cm	L cm	
P398.125	9 x 6	25	24
P398.135	11 x 7	35	12
P398.140	11 x 7	40	12

Resistente hasta 260 °C / Heat resistance to 260 °C /
Résistante à 260 °C / Hitzeresistent bis 260 °C



P3982 Cuchara silicona alta temperatura / High heat silicone spoon / Cuillère silicone haute température / Silikonlöffel hohe Temperaturen



REF	PALA / PEEL / PELLE / SCHAUFEL cm	L cm	
P398.225	9 x 6	25	1
P398.235	11 x 7	35	1
P398.240	11 x 7	40	1

Resistente hasta 260 °C / Heat resistance to 260 °C /
Résistante à 260 °C / Hitzeresistent bis 260 °C

P9602 Espátula multi-usos / Multi-purpose spatula / Spatule multi-usage / Spachtel Multigebrauch

 -5 °C
 +70 °C



REF	L cm	
P960.225*	25	1
P960.230*	30	1
P960.235**	35	1

*Poliestireno / Polystyrene / Polystyrène / Polystyren
**Polietileno / Polyethylene / Polyéthylène / Polyethylen

P807 Rodillo para perforar pasta / Roller docker / Rouleau pour piquer pâtes / Stipprolle



REF	
P807.000	1

P839 Rodillo perforar pasta / Roller docker / Rouleau pour piquer pâtes / Stipprolle



REF	
P839.000	1

P840 Rodillo enrejado / Lattice cutting roller / Rouleau découpoir / Gitterschneiderolle



REF	
P840.000	1

P842 Cortapastas doble. Liso y rizado / Double pastry cutter. Plain and serrated /
 Roulette à pâtes double. Unie et cannelée / Doppelter Teigschneider. Glatt und Gezackt

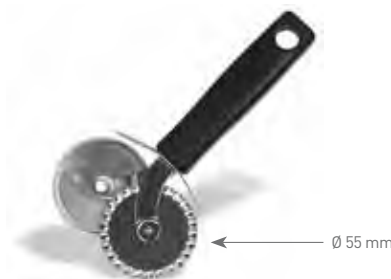

REF	
P842.000	1

P805 Cortapastas extensible 7 ruedas / Extendable cutter roller 7 castors /
 Rouleau extensible 7 roulettes / Ausziehbarer Teigschneider 7 Rollen

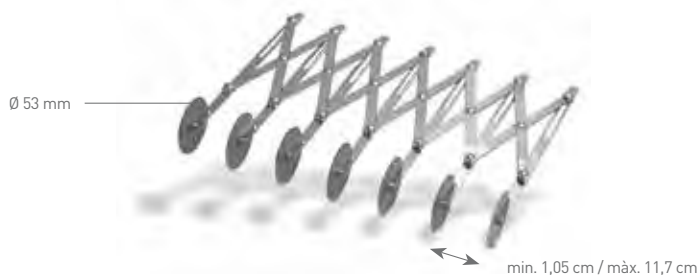

REF	
P805.000	1

9.2 UTENSILIOS DE PASTERÍA / PASTRY UTENSILS / USTENSILES DE PÂTISSERIE / PATISSERIEZUBEHÖR

P801 Rodillo acero inox / St/Steel rolling pin / Rouleau pâtissier acier inox / Teigrolle rostfreier Stahl

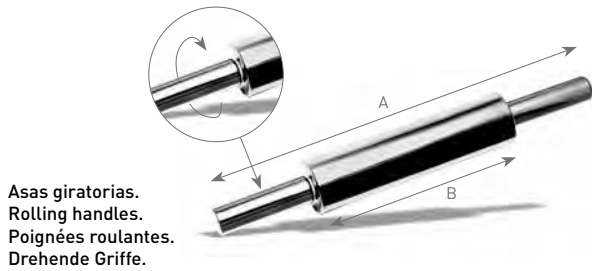

REF	A cm	B cm	Ø cm	
P801.040	40	20	5,1	3
P801.048	48	25	6,4	3

P802 Rodillo polietileno con asas / Polyethylene rolling pin with handles / Rouleau en polyéthylène avec poignées / Teigrolle Polyethylen mit Griffen

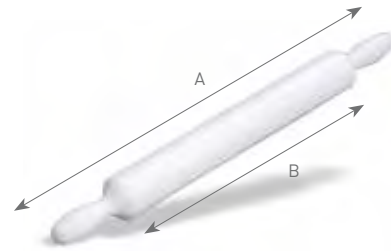

REF	A cm	B cm	Ø cm	
P802.000	60	40	4,8	1

P803 Rodillo polietileno sin asas / Polyethylene rolling Pin without handles / Rouleau en polyéthylène Sans poignées / Teigrolle Polyethylen ohne Griffen



REF	L cm	Ø cm	
P803.000	50	4,8	1

P804 Rodillo de madera / Wooden rolling pin / Rouleau en bois / Holzteigrolle

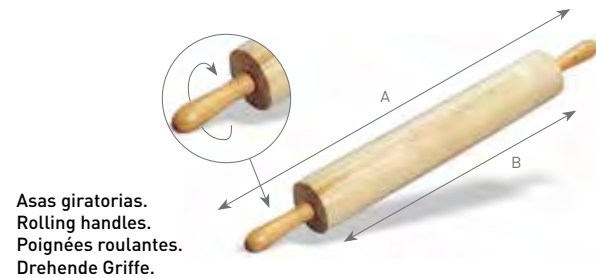

REF	A cm	B cm	Ø cm	
P804.000	67,5	45,5	7,7	1

P845 Pincel de polietileno / Polyethylene brush / Pinceau en polyéthylène / Pinsel Polyethylen

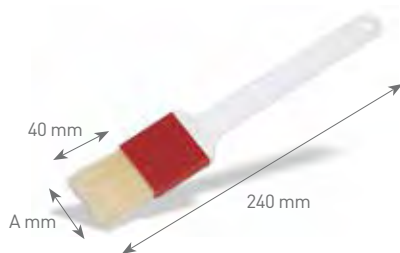

REF	A mm	
P845.040	40	1
P845.050	50	1
P845.060	60	1
P845.075	75	1

P8451 Cepillo plástico + cerdas nylon / Plastic brush + nylon bristle / Pinceau plastique + poils nylon / Plastikbürste + Nylonborsten

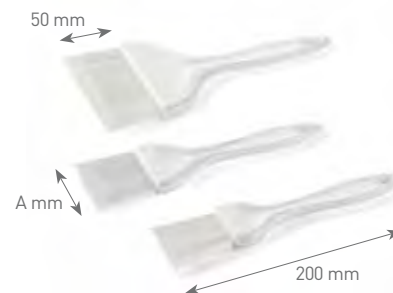

REF	A mm	
P845.138	38	1
P845.155	55	1
P845.110	100	1

P836 Rasquetas de polipropileno / Polypropylene scrapers / Raclettes en polypropylène / Schaber aus Polypropylen

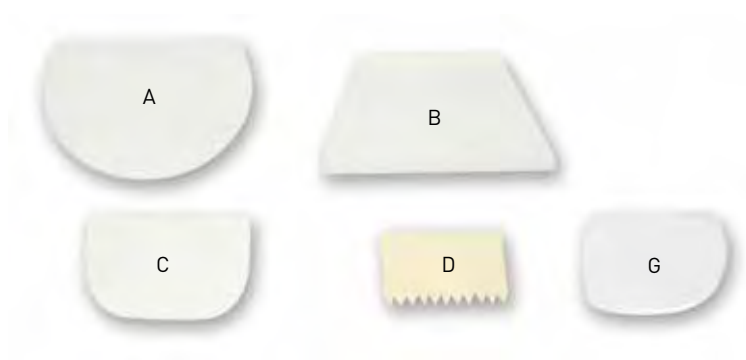

REF		mm	
P836.200	A	204 x 151	1
P836.215	B	221 x 130	1
P836.147	C	151 x 102	1
P836.110	D	112 x 78	1
P836.120	G	128 x 90	1

P848 Marcador de tartas doble / Double cake divider /
Séparateur de portions double / Doppelter Tortenschneider



REF	PORCIONES / PORTIONS / PORTIONEN	
P848.008	8 / 12	1
P848.014	14 / 16	1

Polipropileno. Ø Total: 26,5 cm
Polypropylene.
Polypropylène.
Polypropylen.

P8725 Rasqueta mango ABS / Scraper ABS handle /
Raclette manche ABS / Schaber ABS Griff



REF	cm	
P872.500	21 x 14,5	1

VER PRODUCTOS EN / SEE PRODUCTS ON / VOIR PRODUITS EN PAGE / SIEHE PRODUKTE IN

UTENSILIOS /
UTENSILS /
USTENSILES /
ZUBEHÖR

P. 99





P979 Soplete cocina / Pastry torch by gas / Torche à caraméliser / Küchengasbrenner

CE



Ref. P979.000

Llama super fuerte /
Super strong flame /
Flamme extra fort /
Super starke Flamme

REF	cm	
P979.100	10 x 13,6	1
P979.200	13 x 17,5	1
P979.000	16,5 x 21	1

120 min.
Duración / Lenght /
Durée / Dauer



Descongelación, esterilización, escultura de hielo, crema brûlée, caramelización /

kitchen use, defrosting, sterilizing, ice sculpture, crème brûlée, caramelization /

Décongélation, stérilisation, sculpture de glace, crème brûlée, caramélisation /

Auftauen, Sterilisieren, eisskulptur, Crème Brûlée, Karamelisieren



Ref. P979.100

Llama normal /
Standar flame /
Flamme normal /
Normale Flamme



Ref. P979.200

Llama fuerte /
Strong flame /
Fort flamme /
Starke Flamme

P991 Quemador eléctrico redondo / Round electric caramelizer /
Fer à caraméliser électrique rond / Elektrischer runder Brenner

CE



REF	Ø cm	L cm	W	
P991.010	8	34	400	1

VER PRODUCTOS EN / SEE PRODUCTS ON / VOIR PRODUITS EN PAGE / SIEHE PRODUKTE IN

Termómetro bolsillo con protección /
Pocket thermometer with protection /
Thermomètre de poche avec protection /
Taschenthermometer mit Schutz



P. 144

P837 Expositor de tartas de aluminio / Aluminium cake stand /
Présentoir de tartes en aluminium / Tortenständer aus Aluminium

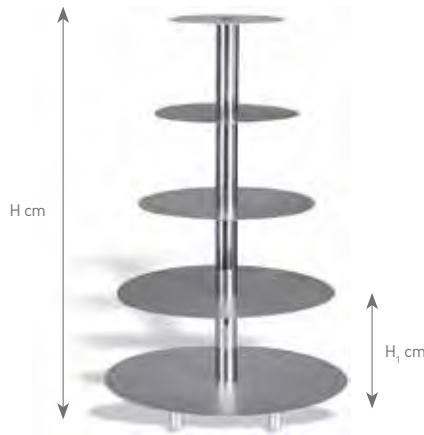

REF	H cm	H ₁ cm	Ø cm	
P837.003	33	2 x 16,5	20 / 26 / 32	1
P837.005	100	4 x 25,0	20 / 26 / 32 / 40 / 45	1
P837.007	120	6 x 20,0	16 / 20 / 26 / 32 / 40 / 45 / 50	1

P8373 Expositor de tartas giratorio / Revolving cake stand /
Présentoir giratoire de tartes / Drehbarer Tortenständer



REF	Ø cm	H cm	
P837.300	30	8	1

P350 Cedazos en acero inox / St/Steel sieves / Tamis en acier inox / Siebe aus rostfreiem Stahl

Detalle de las 6 mallas a escala real.
Detail of the 6 sieves at real scale.
Détail des 6 mailles à échelle réelle.
Detail der 6 Maschen in realer Skala.

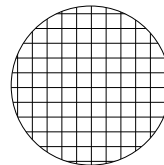

REF	Ø cm	Num	
P350.230	30	10	6
P350.235	35	10	6

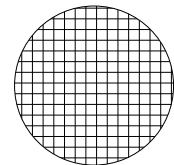

REF	Ø cm	Num	
P350.330	30	14	6
P350.335	35	14	6

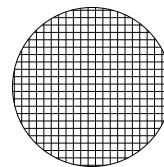

REF	Ø cm	Num	
P350.426	26	20	6
P350.430	30	20	6
P350.435	35	20	6
P350.440	40	20	6

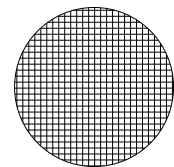

REF	Ø cm	Num	
P350.530	30	25	6
P350.535	35	25	6

NUM.	LUZ DE MALLA / MESH SIZE / MAILLAGE / MASCHENWEITE mm
10	2,000
14	1,400
20	0,850
25	0,710
35	0,500
50	0,300

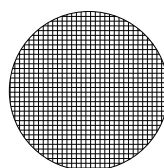

REF	Ø cm	Num	
P350.630	30	35	6
P350.635	35	35	6

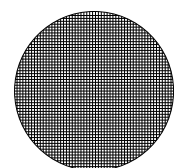

REF	Ø cm	Num	
P350.730	30	50	6
P350.735	35	50	6

P830 Embudo dosificador / Confectionery funnel / Entonnoir doseur / Dosierungstrichter



REF	Lts	
P830.001	1,00	1
P830.002	2,00	1

Boquilla recambio Ø 6 mm
Spare tube Ø 6 mm
Douille rechange Ø 6 mm
Austauschbare Öffnung Ø 6 mm

VER PRODUCTOS EN / SEE PRODUCTS ON / VOIR PRODUITS EN PAGE / SIEHE PRODUKTE IN

P970

Soporte para embudo o chino /
Stand for funnel or chinese colander /
Support pour entonnoir ou chinois /
Ständer für Trichter oder Sieb



P. 113

P830.003 Embudo dosificador económico / Economic confectionery funnel /
Entonnoir doseur économique / Ökonomischer Dosierungstrichter



REF	Lts	
P830.003*	1,00	1
P830.004**		1

*Boquilla de recambio Ø 6 mm.
Spare tube Ø 6 mm.
Douille de rechange Ø 6 mm.
Austauschbare Öffnung Ø 6 mm.

** Soporte embudo. Se vende por separado.
Stand for funnel. Sell separately.
Support pour entonnoir. Vendu séparément.
Trichterständer. Separater Verkauf.

P830.005 Embudo dosificador básico con soporte / Basic confectionery funnel with stand /
Entonnoir doseur de base avec support / Basisdosierungstrichter mit Ständer



REF	Lts	
P830.005	1,00	1

Embudo y soporte se venden conjuntamente.
Funnel and stand sold together.
Entonnoir et support vendu ensemble.
Trichter und Ständer werden zusammen verkauft.

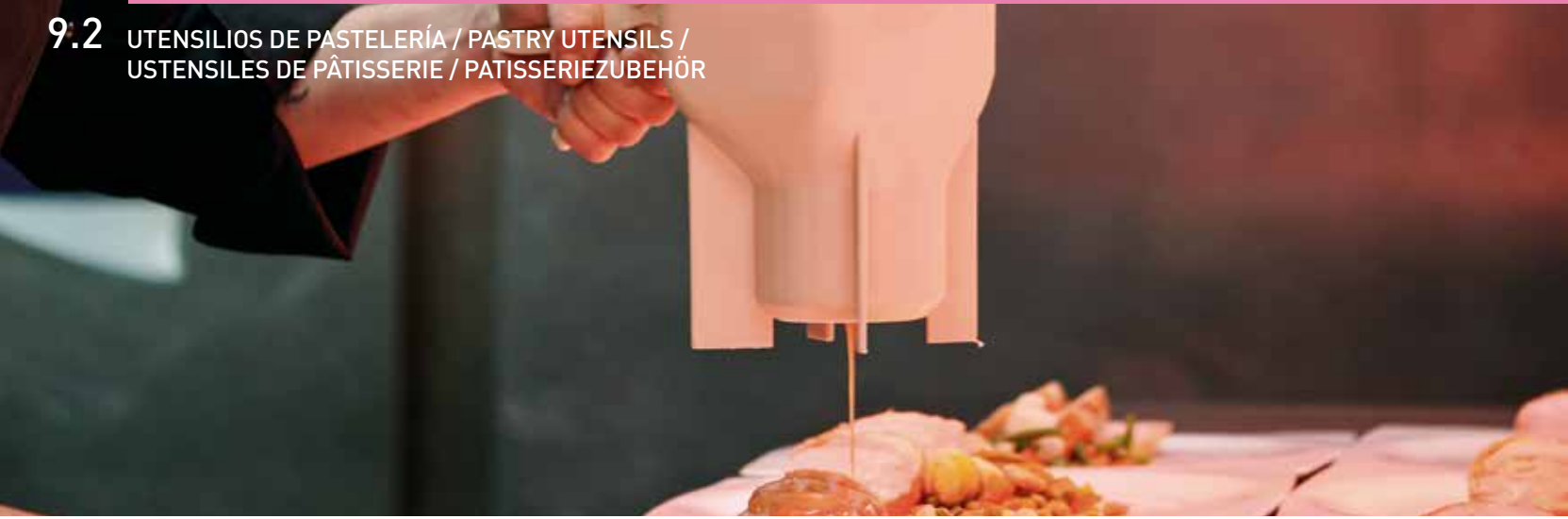

2803 Dispensador con control de porciones / Portion control dispenser /
Distributeur contrôle de la partie / Portionskontrollspender



BATTER BOSS®



REF	L	cm	H cm	
2803-18	1,4	15,6 x 27,6	19,1	1

Los ajustes de control de 8 porciones dispensan de 30 a 90 ml. / 8 portion control settings dispense from 30 a 90 ml. / 8 réglages de dose - 30 à 90 ml. / 8 portionskontrolleinstellungen zur ausgabe von 30-90 ml.

No se recomienda para batidos espesos.
Not recommended for chunky batters.
Non recommandé pour les pâtes grumeleuses.
Nicht für bröselige teige empfohlen.

P9095 Rejilla inox pastelería con pies / St/steel pastry grid with feet /
Grille pâtisserie inox avec pieds / Patisserierost rostfreier Stahl mit Füßen

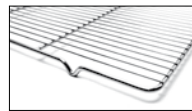

REF	mm	N. TRAVESAÑOS / N. CROSS-BARS / N. TRAVERSES / N. TRAVERSEN	Ø mm TRAVESAÑOS / Ø mm CROSS-BARS / Ø mm TRAVERSES / Ø mm TRAVERSEN	N. VARILLAS / N. WIRES / N. FILS / N. STÄBE	Ø mm VARILLAS / Ø mm WIRES / Ø mm FILS / Ø mm STÄBE	
P909.559	590 x 390 x 20	3	5	29	2	1

VER PRODUCTOS EN / SEE PRODUCTS ON / VOIR PRODUITS EN PAGE / SIEHE PRODUKTE IN

ACCESORIOS HORNO /
OVEN ACCESSORIES /
ACCESSOIRES FOUR /
OFENACCESSORIES



P. 74



P. 78

P7022 Molde cake profesional /
Professional cake mould /
Cake embouti professionnel /
Professionelle Backform



REF	cm (int.)	H cm	Lts	
P702.230	30 x 10,5	8,0	2,0	1

P702 Molde cake /
Cake mould /
Cake embouti /
Backform



REF	cm	H cm	
P702.026	26 x 9,5	7,5	1
P702.028	28 x 10	7,5	1

P704 Molde para paté o cake desmontable /
Folding cake mould /
Pâté ou cake démontable /
Backform für Pastete oder Kuchen demontierbar



REF	cm	H cm	
P704.024	24 x 9,5	7,0	1
P704.030	30 x 10	7,5	1

P709 Molde fondo desmontable /
Baking mould w/removable base /
Tarte maison a/fond amovible /
Backform Boden demontierbar



REF	cm	H cm	
P709.035	35 x 11	2,5	1

P707 Placa madalenas pequeñas /
Small madeleine sheet /
Plaque madeleinettes /
Backblech kleine Madeleine



REF	cm	
P707.039	39,5 x 12,5	6

2 hileras de 10 madalenas pequeñas de 4,2 cm.
2 rows of 10 small madeleines of 4,2 cm.
2 rangées de 10 madeleinettes de 4,2 cm.
2 Reihen von 10 kleinen Madeleinen von 4,2 cm.

P706 Placa madalenas /
Madeleine sheet /
Plaque madeleines /
Backblech Madeleine



REF	cm	
P706.039	39,5 x 20	6

2 hileras de 6 madalenas de 8 cm.
2 rows of 6 madeleines of 8 cm.
2 rangées de 6 madeleines de 8 cm.
2 Reihen von 6 Madeleinen von 8 cm.

9.3 MOLDES ANTIADHERENTES / NON-STICK MOULDS / MOULES ANTI-ADHÉSIFS / ANTIHAFT BACKFORM

P723 Molde desmontable Antiadherente /
Non-stick spring form /
Moule rond démontable /
Demontierbare Backform Antihaft



REF	Ø cm	H cm	
P723.024	24	7,0	1
P723.028	28	7,0	1

P703 Molde para tarta /
High cake mould /
Manqué rond uni /
Tortenbackform



REF	Ø cm	H cm	
P703.020	20	4,5	1
P703.024	24	5,0	1
P703.028	28	5,0	1
P703.032	32	5,5	1

P710 Molde rizado para tarta /
Round tart mould with fluted edges /
Tourtière ronde avec Bord cannelé /
Runde Ecken Tortenbackform



REF	Ø cm	H cm	
P710.020	20	2,5	1
P710.024	24	2,5	1
P710.028	28	2,5	1

P711 Molde rizado fondo desmontable /
Fluted edge mould with removable base /
Tourtière avec fond amovible /
Runde Ecken Backform Boden demontierbar

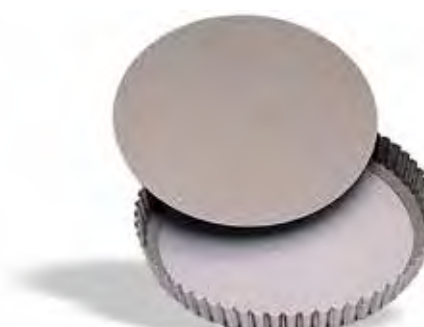

REF	Ø cm	H cm	
P711.010	10	1,8	1
P711.012	12	2,0	1
P711.020	20	2,5	6
P711.024	24	2,5	6
P711.028	28	2,5	6
P711.032	32	2,5	6

P708 Molde savarin / Savarin mould /
Moule savarin / Savarin Backform



REF	Ø cm	H cm	
P708.008	8	2,0	1
P708.022	22	4,5	1
P708.024	24	5,0	1

P712 Molde savarin "trois frères" /
"Trois frères" ring mould /
Moule savarin "trois frères" /
Savarin Backform "trois frères"



REF	Ø cm	H cm	
P712.022	22	5,5	6

P713 Molde ovalado para aspic / Oval aspic mould /
Moule aspic ovale / Ovale Backform für Aspic



REF	cm	H cm	
P713.075	7,5 x 5,5	3,8	6

P715 Molde redondo para bizcocho / Baba mould /
Baba rond / Baba Backform



REF	Ø cm	H cm	
P715.006	6,5	6,0	6

Borde vuelto / Rolled edge /
Bord roulé / Gerollter Rand

VER PRODUCTOS EN / SEE PRODUCTS ON /
VOIR PRODUITS EN PAGE / SIEHE PRODUKTE IN

MAQUINARIA /
MACHINERY /
MACHINES /
MASCHINEN



P. 309

9.3 MOLDES ANTIADHERENTES / NON-STICK MOULDS / MOULES ANTI-ADHÉSIFS / ANTIHAFT BACKFORM

P717 Molde barquita lisa / Plain oval boat mould / Moule Barquette unie / Glatte Schiffchenbackform



REF	cm	H cm	
P717.008	8 x 3,3	1,2	6
P717.010	10 x 4,3	1,3	6

P718 Molde madalenas con 10 costados / 10 Wide ribs brioche mould / Moule brioche 10 côtes / Madeleinenbackform 10 Rundungen



Ø 6: 9 costados. Resto ø: 10 costados / Ø 6: 9 ribs. Other ø: 10 ribs / Ø 6: 9 côtes. Autres ø: 10 côtes / Ø 6: 9 Rundungen. Resto ø: 10 Rundungen

REF	Ø cm	H cm	
P718.006	6	2,5	6
P718.008	8	3,2	6
P718.010	10	3,8	6
P718.011	11	4,0	6

P720 Molde tartaleta acanalada redonda / Round fluted tart mould / Moule tartelette ronde cannelée / Törtchenbackform mit runden Ecken



REF	Ø cm	H cm	
P720.005	5	1,2	6
P720.006	6	1,2	6
P720.007	7	1,2	6
P720.008	8	1,2	6
P720.010	10	1,8	6
P720.012	12	2,0	6

P721 Molde tartaleta redonda lisa / Round plain tart mould / Moule tartelette ronde unie / Glatte runde Törtchenbackform



REF	Ø cm	H cm	
P721.005	5	1,2	6
P721.006	6	1,2	6
P721.007	7	1,2	6
P721.008	8	1,2	6
P721.010	10	1,2	6

P722 Caja de 60 pequeños moldes "Petits fours" / 60 "Petits fours" moulds set / Boîte de 60 "petits fours" / Kisten mit 60 kleinen Backformen "Petits fours"



5 Piezas de cada uno de los 12 "Petits fours".
5 Pieces of each 12 "Petits fours".
5 Pièces de chacun des 12 "Petits fours".
5 Teile von jeden 12 "Petits fours".

REF	
P722.000	1

VER PRODUCTOS EN / SEE PRODUCTS ON / VOIR PRODUITS EN PAGE / SIEHE PRODUKTE IN

JARRAS DE MEDIDAS / MEASURING JUGS / POTS MESUREURS / MESSBECHER



P. 145



P732

Caja de 8 cortapastas redondos lisos /
Set of 8 round plain cutters /
Boîte de 8 découpoirs ronds unis /
Kiste mit 8 runden glatten Teigusstechformen

INOX - ST/STEEL
ROSTFREIER STAHL



REF	Ø cm	H cm	
P732.000	3 / 4 / 5 / 6 / 7 / 8 / 9 / 10	3,5	1

P733

Caja de 8 cortapastas redondos rizados /
Set of 8 round fluted cutters /
Boîte de 8 découpoirs ronds cannelés /
Kiste mit 8 Teigusstechformen mit runden Ecken

INOX - ST/STEEL
ROSTFREIER STAHL



REF	Ø cm	H cm	
P733.000	3 / 4 / 5 / 6 / 7 / 8 / 9 / 10	3,5	1

P796

Caja 9 cortapastas redondos lisos poliglas /
9 pcs set polyglass plain cutters /
Boîte 9 découpoirs ronds unis polyglass /
Kiste mit 9 runden glatten Teigusstechformen Polyglas



REF	Ø cm	H cm	
P796.000	2 / 3 / 4 / 5 / 6 / 7 / 8 / 9 / 10	3,5	1

P7961

Caja 9 cortapastas redondos rizados poliglas /
9 pcs set polyglass fluted cutters /
Boîte 9 découpoirs ronds cannelés polyglass /
Kiste mit 9 Polyglas Teigusstechformen mit runden Ecken



REF	Ø cm	H cm	
P796.100	2 / 3 / 4 / 5 / 6 / 7 / 8 / 9 / 10	3,5	1

P780 Aro redondo para tarta / Tart ring / Cercle à tarte / Runder Tortenring



REF	Ø cm	H cm	
P780.006	6	2,0	1
P780.008	8	2,0	1
P780.010	10	2,0	1

P781 Aro redondo para tarta / "Entremets" ring / Cercle à entremets / Runder Tortenring



REF	Ø cm	H cm	
P781.006	6	3,5	1
P781.008	8	3,5	1
P781.010	10	3,5	1

P785 Aro redondo para mousse / Mousse ring / Cercle à mousse / Runder Moussering



REF	Ø cm	H cm	
P785.006	6	4,0	1
P785.008	8	4,0	1
P785.010	10	4,0	1

P782 Aro redondo para mousse / Mousse ring / Cercle à mousse / Runder Moussering



REF	Ø cm	H cm	
P782.075	7,5	4,0	1
P782.008	8	4,5	1
P782.010	10	4,5	1
P782.012	12	4,5	1
P782.014	14	4,5	1
P782.016	16	4,5	1
P782.018	18	4,5	1
P782.020	20	4,5	1
P782.022	22	4,5	1
P782.024	24	4,5	1
P782.026	26	4,5	1
P782.028	28	4,5	1

P783 Aro redondo para tarta / Ice cream cake ring / Cercle à vacherin / Runder Tortenring





REF	Ø cm	H cm	
P783.006	6	6,0	1
P783.008	8	6,0	1
P783.010	10	6,0	1
P783.012	12	6,0	1
P783.014	14	6,0	1
P783.016	16	6,0	1
P783.018	18	6,0	1
P783.020	20	6,0	1
P783.022	22	6,0	1
P783.024	24	6,0	1
P783.026	26	6,0	1
P783.028	28	6,0	1
P783.030	30	6,0	1

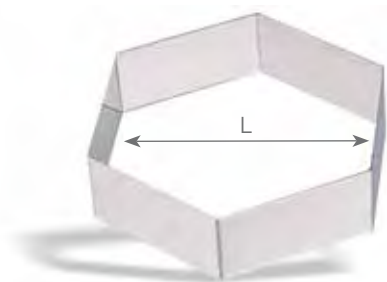

Perfecto para presentación de platos /
Perfect for dishes presentation /
Idéal pour la présentation de plats /
Perfekt für die Tellerpräsentation

P765 Molde hexagonal / Hexagon /
Hexagono / Sechseckige Form



REF	L cm	H cm	
P765.020	20	4,5	1
P765.024	24	4,5	1

P768 Molde forma lágrima / Tear /
Larme / Tränenform



REF	L cm	H cm	
P768.006	6	4,5	1
P768.008	8	4,5	1

P771 Molde forma oval / Oval / Ovale / Ovalform

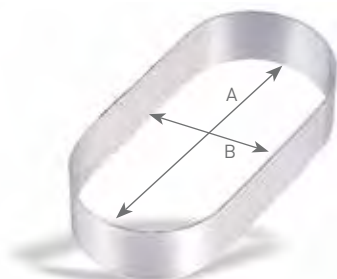

REF	L cm	H cm	
P771.025	25 x 11,2	4,5	1

P769 Molde forma corazón / Heart / Coeur / Herzform

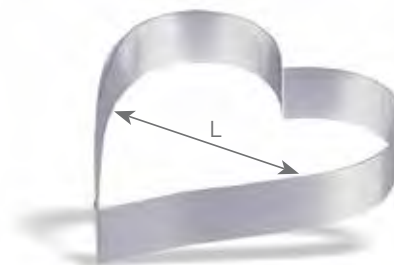

REF	L cm	H cm	
P769.008	8	4,5	1
P769.010	10	4,5	1
P769.018	18	4,5	1
P769.020	20	4,5	1
P769.022	22	4,5	1

P992 Cinta PVC para mousse / PVC ribbon for mousse / Ruban pâtissier en PVC / PVC Band für Mousse



REF	LONGITUD / LENGTH / LONGUEUR / LÄNGEA	H cm	
P992.040	100 m	4,0	1
P992.045	100 m	4,5	1
P992.050	100 m	5,0	1

VER PRODUCTOS EN / SEE PRODUCTS ON / VOIR PRODUITS EN PAGE / SIEHE PRODUKTE IN

PINZA CHEF PRECISIÓN /
FINE TIP STRAIGHT TWEEZER /
PINCE DU CHEF PRÉCISION /
PRÄZISIONSPINZETTE

P. 93



P355 Flanero / Caramel cream mould / Moule à flan / Karamellcremeform

 INOX - ST/STEEL
ROSTFREIER STAHL

REF	Ø cm	H cm	Lts	
P355.007	7,5	5,2	0,12	10
P355.008	8,5	5,4	0,17	10



**P136 Molde industrial para flan / Reinforced caramel cream mould /
Moule à flan / Industrielle Karamellcremeform**

 ALUMINIO /
ALUMINIUM

REF	Ø cm	H cm	Lts	
P136.006	6	5,5	0,10	1
P136.007	7	6,5	0,15	1
P136.008	8	6,5	0,25	1

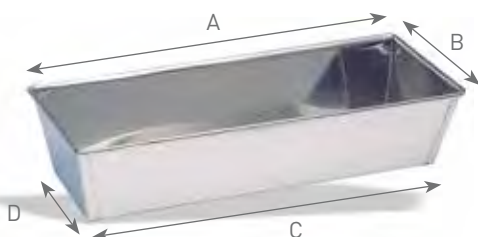

P784 Molde cake / Cake mould / Moule à cake / Kuchenbackform

REF	A x B cm	C x D cm	H cm	
P784.020	20 x 13	18 x 10	8	1
P784.025	25 x 13	22 x 10	8	1
P784.030	30 x 13	27 x 10	8	1
P784.035	35 x 13	32 x 10	8	1
P784.040	40 x 13	36,5 x 10	8	1

**P788 Molde 1/2 caña desmontable triangular / Triangle cake mould /
Gouttière triangulaire / Dreieckige demontierbare Backform**

REF	cm	
P788.025	25 x 9 x 6	1
P788.050	50 x 9 x 6	1

**P789 Molde 1/2 caña desmontable redondo / Round cake mould /
Gouttière ronde / Halbrunde demontierbare Backform**

REF	cm	
P789.025	25 x 9 x 6	1
P789.050	50,5 x 9 x 9	1





P800 Mangas de nylon / Nylon pastry bags / Poches pâtisseries en nylon / Nylon Spritzbeutel



REF	cm	Ø cm	
P800.030	30	17,0	6
P800.035	35	19,5	6
P800.040	40	22,0	6
P800.045	45	25,0	6
P800.050	50	27,5	6
P800.055	55	30,5	6
P800.060	60	33,0	6
P800.065	65	35,0	6
P800.070	70	39,0	6

Fabricadas en nylon y recubiertas de poliuretano por una cara. Impermeables y ultraligeras. Son muy cómodas de utilizar. Se pueden hervir. Sin costuras, termosoldadas de larga duración y con la punta ajustable /

Made in nylon and covered with polyurethane on one side. Waterproof, ultra light and very comfortable to use. Sterilizable, without seams, thermowelded for long life and with an adjustable end /

Fabriquées en tissu de nylon avec un revêtement polyuréthane sur une face. Impérmeables, très souples, ultralégères et très comodes au tact. Stérilisables, sans coutures, thermosoudées, de longue durée et avec l'embout ajustable /

Hergestellt aus Nylon und auf einer Seite mit Polyurethan beschichtet. Undurchlässig und ultraleicht. Sie sind sehr einfach zu benutzen. Sie lassen sich abkochen. Ohne Nähte, langlebige Hitzeverschweißung mit einer anpassbaren Spitze.

P851 Manga pastelera de algodón / Cotton pastry bag / Poches pâtisseries en cotton / Baumwolle Spritzbeutel



REF	L cm	
P851.040	40	1
P851.046	46	1
P851.050	50	1

P798 Mangas desechables / Disposable pastry bags / Poches jetables / Einweg Spritzbeutel



Caja de 100 unidades /
100 pieces set /
Boîte de 100 pièces /
Kiste von 100 Stück.

REF	cm	Lts	
P798.040	43	2,00	1
P798.055	55	3,50	1
P798.065	65	5,00	1

P798056 Mangas desechables color verde / Green disposable pastry bags /
Poches jetables vertes / Einweg-Spritzbeutel grün



REF	cm	Lts	
P798.056	55	3,50	1

Caja de 100 unidades / 100 pieces set /
Boîte de 100 pièces / Kiste von 100 Stück.

P849 Soporte para mangas pasteleras y boquillas / Support for pastry bags and tubes (nozzles) /
Support pour pochés pâtisseries et douilles / Ständer für Spritzbeutel und Tüllen



REF	
P849.000	1

VER PRODUCTOS EN / SEE PRODUCTS ON / VOIR PRODUITS EN PAGE / SIEHE PRODUKTE IN

PAPEL SILICONADO /
SILICONIZED BAKING RELEASE PAPERS /
PAPIER SILICONÉ ANTI-ADHÉSIF /
BACKPAPIER AUS SILIKON



P. 78



P810 Boquilla redonda / Plain tube / Douille unie / Rundtülle

	Ø	REF	Ø mm	
		P810.004	4	25
		P810.006	6	25
		P810.008	8	25
		P810.010	10	25
		P810.012	12	25
		P810.014	14	25

P811 Boquilla estrella / Star tube / Douille cannelée / Sterntülle

	Ø	REF	Ø mm	Nº PUNTAS / Nº TEETH / Nº DENTS / Nº ECKEN	
		P811.004	4	6	25
		P811.006	6	6	25
		P811.008	8	6	25
		P811.010	10	7	25
		P811.012	12	7	25
		P811.014	14	8	25
		P811.016	16	9	25
		P811.018	18	10	25

P812 Boquilla estrella cerrada/ Closed star tube / Douille cannelée fermée / Geschlossene Sterntülle

	Ø	REF	Ø mm	Nº PUNTAS / Nº TEETH / Nº DENTS / Nº ECKEN	
		P812.003	3	6	25
		P812.005	5	6	25
		P812.007	7	6	25
		P812.009	9	8	25
		P812.011	11	8	25

P813 Boquilla cinta estrella / Yule log tube / Douille à bûche de Noël / Sternbandtülle

		REF	mm	Nº PUNTAS / Nº TEETH / Nº DENTS / Nº ECKEN	
		P813.016	16 x 2	6	25
		P813.020	20 x 3	6	25
		P813.028	28 x 4	6	25

P816 Boquilla flor / Flower tube / Douille fleur / Blumentülle

	Ø	REF	Ø mm	Nº PUNTAS / Nº TEETH / Nº DENTS / Nº ECKEN	
		P816.011	11	6	25
		P816.013	13	8	25
		P816.015	15	9	25

P817 Boquilla flor cerrada / Closed flower tube / Douille fleur fermée / Geschlossene Blumentülle

	Ø	REF	Ø mm	Nº PUNTAS / Nº TEETH / Nº DENTS / Nº ECKEN	
		P817.005	5	6	25
		P817.006	6	8	25
		P817.008	8	9	25

9.6 MANGAS Y BOQUILLAS / BAGS AND TUBES / POCHES ET DOUILLES / SPRITZBEUTEL UND TÜLLEN

P815 Boquilla rizada / "petits fours" tube / Douille à "petits fours" / Tülle "petits fours"

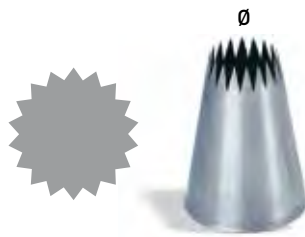

REF	Ø mm	Nº PUNTAS / Nº TEETH / Nº DENTS / Nº ECKEN	
P815.004	4	9	25
P815.006	6	9	25
P815.009	9	12	25
P815.012	12	15	25
P815.015	15	16	25
P815.018	18	18	25

P814 Boquilla para relleno / Bismark tube / Douille petit chou / Fülltülle



REF	Ø mm	
P814.000	4	25

P820 Conjunto de 6 boquillas nº 0 / Set of 6 tubes nr. 0 / Boîte de 6 douilles num. 0 / Set von 6 Tüllen Nr. 0



REF	
P820.000	1

Los gráficos de los diámetros de los agujeros de salida de las boquillas son a tamaño real / Diameter exit holes of the tubes are drawn at real size.
Les graphiques des diamètres des embouts de sortie des douilles sont en taille réelle / Der abgebildete Durchmesser der Öffnungen entspricht der realen Grösse.

1 Boquilla redonda 4 mm
1 Plain tube 4 mm
1 Douille unie 4 mm
1 Rundtülle 4 mm

1 Boquilla cinta estrella 20 x 3 mm
1 Yule log 20 x 3 mm
1 Douille à bûche de Noël 20 x 3 mm
1 Sternbandtülle 20 x 3mm

1 Boquilla estrella 12 mm
1 Star tube 12 mm
1 Douille cannelée 12 mm
1 Sterntülle 12 mm

1 Boquilla estrella 8 mm
1 Star tube 8 mm
1 Douille cannelée 8 mm
1 Sterntülle 8 mm

1 Boquilla redonda 8 mm
1 Plain tube 8 mm
1 Douille unie 8 mm
1 Rundtülle 8 mm

1 Boquilla flor 11 mm
1 Flower tube 11 mm
1 Douille fleur 11 mm
1 Blumentülle 11 mm

P821 Conjunto de 6 boquillas nº 1 / Set of 6 tubes nr. 1 / Boîte de 6 douilles num. 1 / Set von 6 Tüllen Nr. 1



REF	
P821.000	1

Los gráficos de los diámetros de los agujeros de salida de las boquillas son a tamaño real / Diameter exit holes of the tubes are drawn at real size.
Les graphiques des diamètres des embouts de sortie des douilles sont en taille réelle / Der abgebildete Durchmesser der Öffnungen entspricht der realen Grösse.

1 Boquilla redonda 2 mm
1 Plain tube 2 mm
1 Douille unie 2 mm
1 Rundtülle 2 mm

1 Boquilla redonda 6 mm
1 Plain tube 6 mm
1 Douille unie 6 mm
1 Rundtülle 6 mm

1 Boquilla redonda 10 mm
1 Plain tube 10 mm
1 Douille unie 10 mm
1 Rundtülle 10 mm

1 Boquilla redonda 4 mm
1 Plain tube 4 mm
1 Douille unie 4 mm
1 Rundtülle 4 mm

1 Boquilla redonda 8 mm
1 Plain tube 8 mm
1 Douille unie 8 mm
1 Rundtülle 8 mm

1 Boquilla redonda 12 mm
1 Plain tube 12 mm
1 Douille unie 12 mm
1 Rundtülle 12 mm

P822 Conjunto de 6 boquillas nº 2 / Set of 6 tubes nr. 2 /
Boîte de 6 douilles num. 2 / Set von 6 Tüllen Nr. 2



REF



P822.000

1

Los gráficos de los diámetros de los agujeros de salida de las boquillas son a tamaño real / Diameter exit holes of the tubes are drawn at real size
Les graphiques des diamètres des embouts de sortie des douilles sont en taille réelle / Der abgebildete Durchmesser der Öffnungen entspricht der realen Größe.

- | | | |
|--|--|--|
| <ul style="list-style-type: none"> ★ 1 Boquilla estrella 2 mm 1 Star tube 2 mm 1 Douille cannelée 2 mm 1 Sterntülle 2 mm | <ul style="list-style-type: none"> ★ 1 Boquilla estrella 6 mm 1 Star tube 6 mm 1 Douille cannelée 6 mm 1 Sterntülle 6 mm | <ul style="list-style-type: none"> ★ 1 Boquilla estrella 10 mm 1 Star tube 10 mm 1 Douille cannelée 10 mm 1 Sterntülle 10 mm |
| <ul style="list-style-type: none"> ★ 1 Boquilla estrella 4 mm 1 Star tube 4 mm 1 Douille cannelée 4 mm 1 Sterntülle 4 mm | <ul style="list-style-type: none"> ★ 1 Boquilla estrella 8 mm 1 Star tube 8 mm 1 Douille cannelée 8 mm 1 Sterntülle 8 mm | <ul style="list-style-type: none"> ★ 1 Boquilla estrella 12 mm 1 Star tube 12 mm 1 Douille cannelée 12 mm 1 Sterntülle 12 mm |

P823 Conjunto de 6 boquillas nº 3 / Set of 6 tubes nr. 3 /
Boîte de 6 douilles num. 3 / Set von 6 Tüllen Nr. 3



REF



P823.000

1

Los gráficos de los diámetros de los agujeros de salida de las boquillas son a tamaño real / Diameter exit holes of the tubes are drawn at real size
Les graphiques des diamètres des embouts de sortie des douilles sont en taille réelle / Der abgebildete Durchmesser der Öffnungen entspricht der realen Größe.

- | | | |
|--|---|--|
| <ul style="list-style-type: none"> ★ 1 Boquilla rizada 12 mm 1 "Petits fours" tube 12 mm 1 Douille à "petits fours" 12 mm 1 Tülle "petits fours" 12 mm | <ul style="list-style-type: none"> ★ 1 Boquilla estrella cerrada 7 mm 1 Closed star tube 7 mm 1 Douille cannelée fermée 7 mm 1 Geschlossene Sterntülle 7 mm | <ul style="list-style-type: none"> ★ 1 Boquilla estrella 8 mm 1 Star tube 8 mm 1 Douille cannelée 8 mm 1 Sterntülle 8 mm |
| <ul style="list-style-type: none"> ★ 1 Boquilla flor 13 mm 1 Flower tube 13 mm 1 Douille fleur 13 mm 1 Blumentülle 13 mm | <ul style="list-style-type: none"> ★ 1 Boquilla flor cerrada 6 mm 1 Closed flower tube 6 mm 1 Douille fleur fermée 6 mm 1 Geschlossene Blumentülle 6 mm | <ul style="list-style-type: none"> ● 1 Boquilla redonda 10 mm 1 Plain tube 10 mm 1 Douille unie 10 mm 1 Rundtülle 10 mm |

P824 Conjunto de 12 boquillas nº 4 / Set of 12 tubes nr. 4 /
Boîte de 12 douilles num. 4 / Set von 12 Tüllen Nr. 4



REF



P824.000

1

Los gráficos de los diámetros de los agujeros de salida de las boquillas son a tamaño real / Diameter exit holes of the tubes are drawn at real size
Les graphiques des diamètres des embouts de sortie des douilles sont en taille réelle / Der abgebildete Durchmesser der Öffnungen entspricht der realen Größe.

- | | | |
|--|---|---|
| <ul style="list-style-type: none"> ● 1 Boquilla redonda 6 mm 1 Plain tube 6 mm 1 Douille unie 6 mm 1 Rundtülle 6 mm | <ul style="list-style-type: none"> ★ 1 Boquilla estrella cerrada 7 mm 1 Closed star tube 7 mm 1 Douille cannelée fermée 7 mm 1 Geschlossene Sterntülle 7 mm | <ul style="list-style-type: none"> ★ 1 Boquilla rizada 15 mm 1 "Petits fours" tube 15 mm 1 Douille à "petits fours" 15 mm 1 Tülle "petits fours" 15 mm |
| <ul style="list-style-type: none"> ● 1 Boquilla redonda 10 mm 1 Plain tube 10 mm 1 Douille unie 10 mm 1 Rundtülle 10 mm | <ul style="list-style-type: none"> ★ 1 Boquilla estrella cerrada 11 mm 1 Closed star tube 11 mm 1 Douille cannelée fermée 11 mm 1 Geschlossene Sterntülle 11 mm | <ul style="list-style-type: none"> ★ 1 Boquilla flor 11 mm 1 Flower tube 11 mm 1 Douille fleur 11 mm 1 Blumentülle 11 mm |
| <ul style="list-style-type: none"> ★ 1 Boquilla estrella 8 mm 1 Star tube 8 mm 1 Douille cannelée 8 mm 1 Sterntülle 8 mm | <ul style="list-style-type: none"> ★ 1 Boquilla cinta estrella 20 mm 1 Yule log tube 20 mm 1 Douille à bûche de Noël 20 mm 1 Sternbandtülle 20 mm | <ul style="list-style-type: none"> ★ 1 Boquilla flor 15 mm 1 Flower tube 15 mm 1 Douille fleur 15 mm 1 Blumentülle 15 mm |
| <ul style="list-style-type: none"> ★ 1 Boquilla estrella 12 mm 1 Star tube 12 mm 1 Douille cannelée 12 mm 1 Sterntülle 12 mm | <ul style="list-style-type: none"> ★ 1 Boquilla rizada 9 mm 1 "Petits fours" tube 9 mm 1 Douille à "petits fours" 9 mm 1 Tülle "petits fours" 9 mm | <ul style="list-style-type: none"> ★ 1 Boquilla flor cerrada 8 mm 1 Closed flower tube 8 mm 1 Douille fleur fermée 8 mm 1 Geschlossene Blumentülle 8 mm |

9.6 MANGAS Y BOQUILLAS / BAGS AND TUBES / POCHES ET DOUILLES / SPRITZBEUTEL UND TÜLLEN

P853 Boquilla redonda de policarbonato / Polycarbonate plain tube / Douille unie en polycarbonate / Rundtülle Polycarbonat



REF	Ø mm	Num.	
P853.004	4	0	1
P853.006	6	2	1
P853.008	8	4	1
P853.010	10	6	1
P853.012	12	8	1
P853.014	14	10	1

P854 Boquilla estrella de policarbonato / Polycarbonate star tube / Douille cannelée en polycarbonate / Sterntülle Polycarbonat



REF	Ø cm	Nº PUNTAS / Nº TEETH / Nº DENTS / Nº ZACKEN	Num.	
P854.006	6	7	2	1
P854.008	8	7	4	1
P854.010	10	7	6	1
P854.012	12	7	8	1
P854.014	14	8	10	1
P854.016	16	8	12	1

P855 Conjunto de 6 boquillas de policarbonato nº 5 / Set of 6 polycarbonate tubes nº 5 / Boîte de 6 douilles en polycarbonate nº 5 / Set von 6 Tüllen Polycarbonat Nr. 5

Boquilla redonda
Plain tube
Douille unie
Rundtülle



REF	
P855.000	1

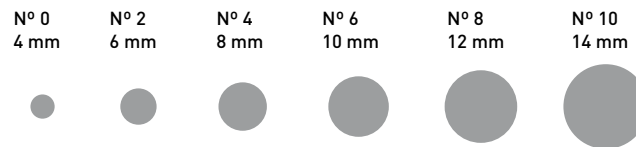

P856 Conjunto de 6 boquillas de policarbonato nº 6 / Set of 6 polycarbonate tubes nº 6 / Boîte de 6 douilles en polycarbonate nº 6 / Set von 6 Tüllen Polycarbonat Nr. 6

Boquilla estrella
Star tube
Douille cannelée
Sterntülle



REF	
P856.000	1

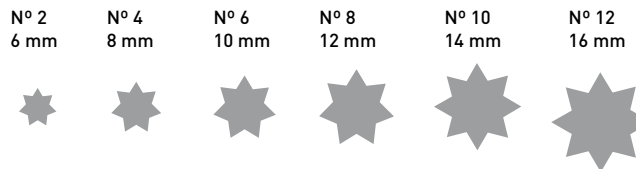

P857 Conjunto de 12 boquillas de policarbonato nº 12 / Set of 12 polycarbonate tubes nº 12 / Boîte de 12 douilles en polycarbonate nº 12 / Set von 12 Tüllen Polycarbonat Nr. 12

Boquilla redonda
Plain tube
Douille unie
Rundtülle



REF	
P857.000	1

Boquilla estrella
Star tube
Douille cannelée
Sterntülle

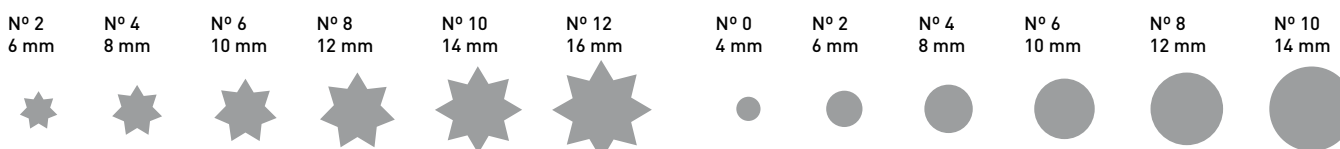



MEDIDAS /
SIZES /
MESURES /
GRÖSSEN

GN 1/3

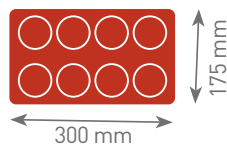

GN 1/1

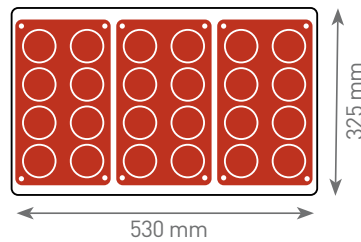

Pastelería / Pastry / Pâtisserie / Pâtisserie

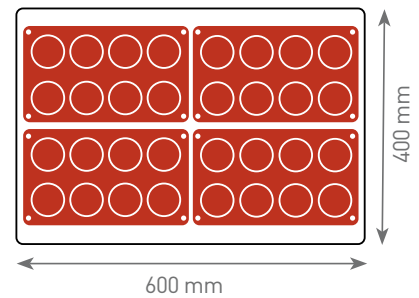

100%

SILICONA /
SILICONE /
SILICONE /
SILIKON

FLEXIBILIDAD /
FLEXIBILITY /
FLEXIBILITÉ /
FLEXIBILITÄT

IDEA!

Ideal para congelador. Puede ser utilizado para preparar todo tipo de pequeña repostería, galletas o chocolates.
ideal for freezing. It can also be used for all preparations of cakes, chocolates, petit-fours, and catering preparations.
Idéal pour la congélation. Utilisable pour tout type de préparations de cakes, chocolats, petits fours, et préparations traiteurs.
Ideal für den Gefrierschrank. Sie sind geeignet für alle Arten der Zubereitung von kleinen Nachspeisen, Keksen oder Schokoladen.

● -60 °C / - 140 °F
● +230 °C / + 446 °F



H.A.C.C.P.
NO PROBLEM

9.7 MOLDES SILICONA / SILICONE MOULDS / MOULES SILICONE / SILIKONBACKFORMEN

MEDIA BOLA

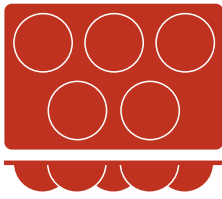

REF	Fig	Ø mm	H mm
P850.001	5 5	80	40

MEDIA BOLA

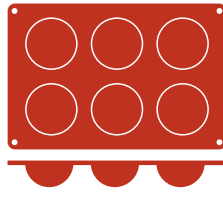

REF	Fig	Ø mm	H mm
P850.002	6 6	70	35

MEDIA BOLA

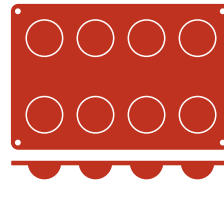

REF	Fig	Ø mm	H mm
P850.003	8 8	60	30

MEDIA BOLA

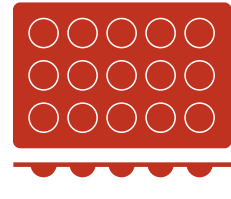

REF	Fig	Ø mm	H mm
P850.004	15 15	15	25

MEDIA BOLA

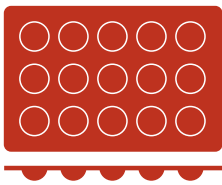

REF	Fig	Ø mm	H mm
P850.005	15 15	40	20

MEDIA BOLA

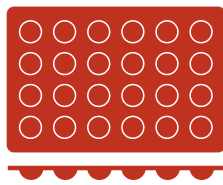

REF	Fig	Ø mm	H mm
P850.006	24 24	30	15

PIRAMIDE



REF	Fig	Ø mm	H mm
P850.007	6 6	71 x 71	40

SAVARIN

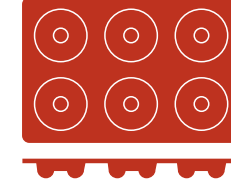

REF	Fig	Ø mm	H mm
P850.012	6 6	72	23

OVAL

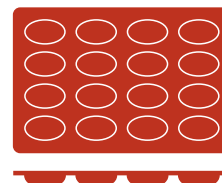

REF	Fig	Ø mm	H mm
P850.017	24 24	30	15

OVAL

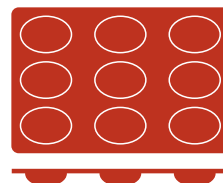

REF	Fig	Ø mm	H mm
P850.018	9 9	70 x 50	20

MUFFIN

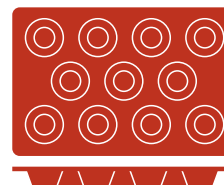

REF	Fig	Ø mm	H mm
P850.022	11 11	50	28

MUFFIN

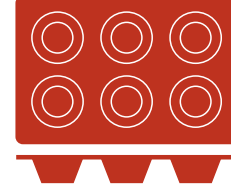

REF	Fig	Ø mm	H mm
P850.023	6 6	70	37

MUFFIN

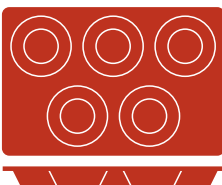

REF	Fig	Ø mm	H mm
P850.024	5 5	80	35

CAKE

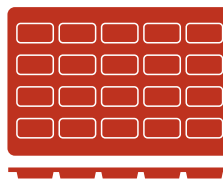

REF	Fig	Ø mm	H mm
P850.025	20 20	49 x 26	11

CAKE

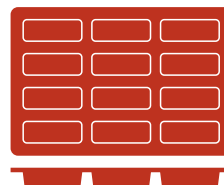

REF	Fig	Ø mm	H mm
P850.026	12 12	80 x 30	30

PETIT FOUR

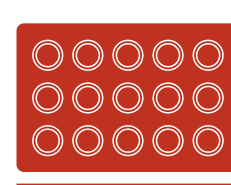

REF	Fig	Ø mm	H mm
P850.027	15 15	40	20

CILINDRO

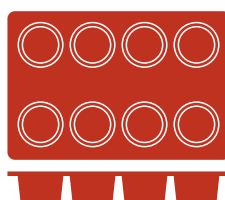

REF	Fig	Ø mm	H mm
P850.028	8 8	60	35

MADALENA

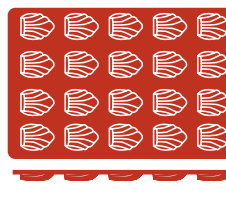

REF	Fig	Ø mm	H mm
P850.031	20 20	38 x 30	10

BORDELAIS

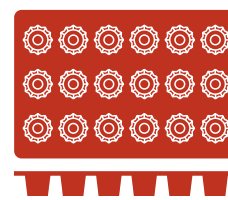

REF	Fig	Ø mm	H mm
P850.033	18 18	35	35

P8504 Molde cake / Cake mould / Moule à cake / Kuchenbackform



REF	cm	
P850.424	24 x 10,5 x 6,5	1
P850.426	26 x 10 x 7	1

P8501 Molde tarta / High cake mould / Manqué rond uni / Tortenbackform



REF	Ø cm	H cm	
P850.124	24	4,2	1
P850.128	28	4,7	1

P8502 Molde savarin alto / Gugelhoph / Moule savarin haut / Hohe Savarinbackform



REF	Ø cm	H cm	
P850.222	22,5	11,5	1

Nueva forma
New shape
Nouvelle forme
Neue Form

P8505 Molde rizado para tarta / Round tart mould with fluted edges /
Tourtière ronde avec bord cannelé / Tortenbackform mit runden Ecken



REF	Ø cm	H cm	
P850.528	28	3,0	1

Nueva forma
New shape
Nouvelle forme
Neue Form

P8506 Flanero rizado / Brioche mould / Moule à brioche / Briochebackform



REF	Ø cm	H cm	
P850.614	14	5,0	1

9.7 MOLDES SILICONA / SILICONE MOULDS / MOULES SILICONE / SILIKONBACKFORMEN

Moldes de silicona 600 x 400 mm Ofrecen la posibilidad de dividirlos en 2 moldes de 300 x 200 mm gracias a su diseño simétrico / Silicone moulds 600 x 400 mm. Possible to divide in two of 300 x 200 mm thanks to its symmetrical design / Moules en silicone 600 x 400 mm avec possibilité de diviser en deux moules de 300 x 200 mm grâce à sa symetrie / Silikonformen 600 x 400 mm. Dank seinem symmetrischen Design können sie in zwei Formen von 300 x 200 mm geteilt werden.

P859900 Mini-cakes / Mini-cakes / Mini-cakes / Minikuchen

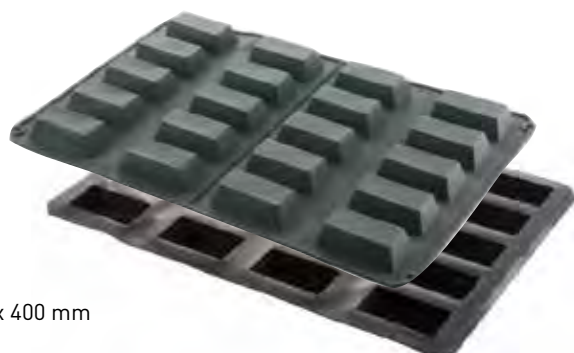

600 x 400 mm

REF	Fig	mm1	mm2	H mm	
P859.900	20	100 x 50	80 x 30	30	1

P859901 Briochette



600 x 400 mm

REF	Fig	Ø mm	H mm	
P859.901	24	79	37	1

P859902 Semi-esferas / Half-spheres / Demi-sphères / Halbkugeln



600 x 400 mm

REF	Fig	Ø mm	H mm	
P859.902	24	70	35	1

P859903 Muffin



600 x 400 mm

REF	Fig	Ø mm	H mm	
P859.903	24	70	42	1

P859904 Mini muffin



600 x 400 mm

REF	Fig	Ø mm	H mm	
P859.904	20	50	28	1

P859905 Gugelhopf



600 x 400 mm

REF	Fig	Ø mm	H mm	
P859.905	24	70	36	1

P859906 Savarin



600 x 400 mm

REF	Fig	Ø mm	H mm	
P859.906	24	72	23	1

P859907 Mini madalenas / Mini madeleines /
Mini madeleines / Minimadeleines



600 x 400 mm

REF	Fig	mm	H mm	
P859.907	84	42 x 30	11	1

P859908 Tartaletas / Tartalets /
Tartalettes / Törtchen



600 x 400 mm

REF	Fig	Ø mm	H mm	
P859.908	60	50	15	1

P859909 Canalados / Cannelés



600 x 400 mm

REF	Fig	Ø mm	H mm	
P859.909	60	85	50	1

P859910 Piramides / Pyramids /
Pyramides / Pyramiden

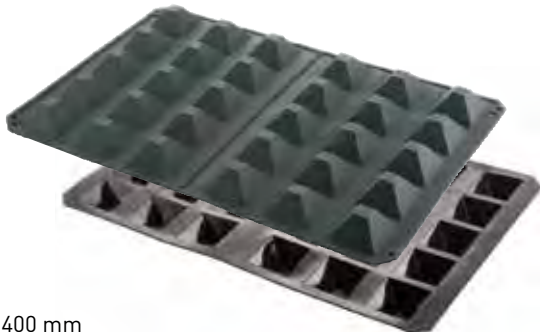

600 x 400 mm

REF	Fig	mm	H mm	
P859.910	30	71 x 71	40	1

P859911 Florentinas / Florentiners /
Florentins / Florentiner



600 x 400 mm

REF	Fig	Ø mm	H mm	
P859.911	40	55	12	1

9.8 MOLDES FLEXIPAN / FLEXIPAN MOULDS / MOULES FLÉXIPAN / FLEXIPANFORMEN

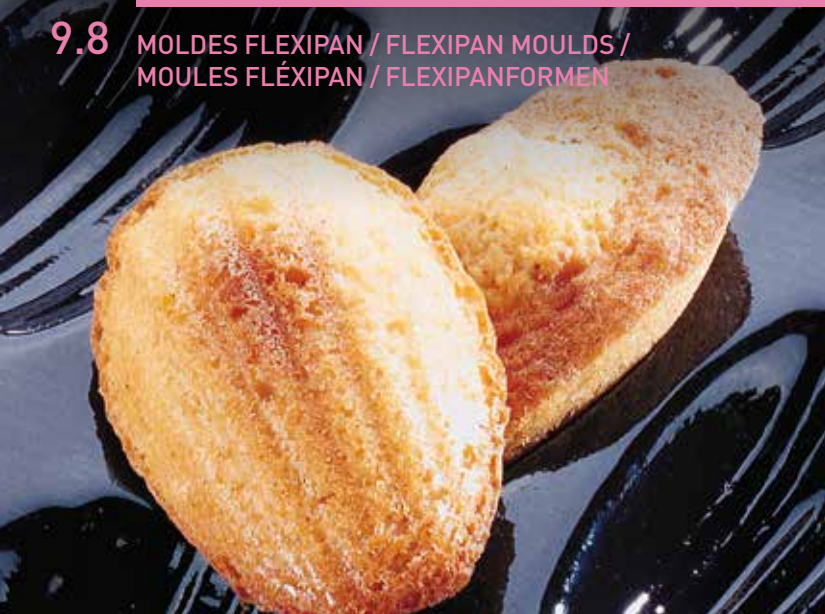

FLEXIPAN® ORIGINE



ESPAÑOL

El Flexipan® es una combinación de fibras de vidrio y sílica adecuadas para el uso alimentario.

Esta combinación de materiales le da a la pieza una solidez y duración de vida inigualables, así como propiedades anti-adherentes excepcionales tanto en cocción como en congelación.

El Flexipan® no requiere ser engrasado ya que su composición y flexibilidad permiten un desmoldeo fácil y rápido.

El Flexipan® con un uso y trato correctos nos permite realizar entre 2.000 y 3.000 cocciones antes de empezar a notar los primeros signos de deterioro.

El Flexipan® permite realizar cualquier tipo de preparaciones dulces o saladas, tanto en cocción (+280 °C) como en congelación (-40 °C).

VENTAJAS FLEXIPAN®

- No es necesario engrasar los moldes para obtener un desmoldeo perfecto
- Gran facilidad para el desmoldeo de piezas congeladas
- La limpieza de los moldes se realiza de una manera fácil y rápida
- Larga vida de la pieza (2.000-3.000) cociones
- Medidas para pastelería profesional (60x40 cm)
- Gama completa de formas

FRANÇAIS

Le Flexipan® est une combinaison de tissus de verre et silicones adéquats pour l'utilisation alimentaire. Cette combinaison de matériels donne au moule une solidité et une durabilité extraordinaire, alliées à des propriétés anti-adhérentes exceptionnelles tant en cuisson comme en congélation. Le Flexipan® n'a pas besoin d'être lubrifié puisque sa composition et flexibilité permettent un démoulage facile et rapide. Selon l'utilisation et l'entretien des moules, le Flexipan®, nous permet d'effectuer entre 2.000 et 3.000 cuissons avant de noter les premiers signes de collage. Le Flexipan® permet d'effectuer tous types de préparations sucrées ou salées, en cuisson (+ 280 °C) ou en congélation (-40 °C).

AVANTAGES FLEXIPAN®

- Ne précise d'aucun graissage pour un démoulage facile et rapide
- Facile à nettoyer
- De 2000 à 3000 cuissons par moule
- Mesures pour la pâtisserie professionnelle (60x40 cm)
- Large gamme de moules

MEDIDAS SIZES MESURES GRÖSSE

Pastelería / Pastry /
Pâtisserie / Patisserie

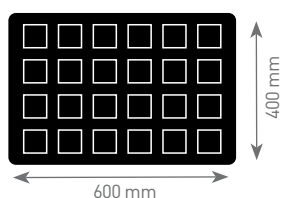

● - 40 °C / - 104 °F
● + 280 °C / + 539 °F



H.A.C.C.P.
NO PROBLEM

ENGLISH

The Flexipan® is a silicone and fibre glass combination mould suitable for the food contact. This material combination gives to the piece solidity and an extraordinary durability, allied with exceptional non-stick properties either for cooking and freezing. The Flexipan® does not require to be lubricated since their composition and flexibility allow an easy and fast release from the mould. According to the use and the maintenance, the Flexipan®, enable us to use them between 2000 and 3000 times before the first signs of sticking arise. The FLEXIPAN can be used to bake (+280 °C) or freeze (-40 °C) the most sweet and savoury products.

ADVANTAGES FLEXIPAN®

- No need to be greased for an easy and quick realise
- Easy to clean
- Between 2000 and 3000 times can be used
- Professional pastry measures (60x40 cm)
- Large range of moulds

DEUTSCH

Flexipan® ist eine Kombination aus Fiberglas und Silikon angepasst an die lebensmittelverarbeitung.

Diese Materialkombination gibt der Form sowohl eine Festigkeit und eine unvergleichliche Langlebigkeit, als auch antihafteigenschaften Während des Backens und der Einfrierung.



Flexipan® braucht keine Einfettung aufgrund seiner zusammenstellung und erlaubt eine schnelle und einfache Ablösung von der form. Flexipan® bietet bei einem korrekten Gebrauch und Behandlung die realisierung zwischen 2.000 und 3.000 Backungen bevor man die ersten Verschleisserscheinungen bemerkt. Flexipan® erlaubt die Realisierung aller Arten der Zubereitung von nachspeisen sowohl beim Backen (+280 °C) als auch beim Einfrieren (-40 °C).

Vorteile FLEXIPAN®

- Keine Einfettung nötig um ein perfektes Ablösen von der form zu erreichen
- Einfachste Ablösung der eingefrorenen Stücke von der form
- einfache und Schnelle Reinigung der Formen
- Langlebigkeit der Formen (2.000-3.000) Backungen
- Größe für die professionelle Patisserie (60x40 cm)
- Grosse Produktvielfalt

CONOS / CONES / CONES / KEGEL





REF	Forma	Fig	Ø mm	H mm	ml	
P859.134		40	50	40,0	24	1
P859.135		20	70	60,0	80	1



BAVAROIS / ROSACE SHAPE / BAVAROIS / BAYERISCH





REF	Forma	Fig	Ø mm	H mm	ml	
P859.139		18	78	35,0	100	1



CHARLOTTES





REF	Forma	Fig	Ø mm	H mm	ml	
P859.141		24	62	35,0	60	1
P859.113		18	78	40,0	100	1



MAGDALENAS / MADELEINES /MADELEINES / MADELEINES





REF	Forma	Fig	mm	H mm	ml	
P859.142		56	52 x 33	15,0	15	1
P859.115		40	78 x 47	19,0	35	1



CONCHAS / SAINT JACQUES SHELL / COQUILLES SAINT-JACQUES / JAKOBSMUSCHELN





REF	Forma	Fig	mm	H mm	ml	
P859.132		24	80 x 75	20,0	70	1



9.8 MOLDES FLEXIPAN / FLEXIPAN MOULDS / MOULES FLÉXIPAN / FLEXIPANFORMEN

MARGARITAS / DEEP FLOWER / MARGUERITES EN RELIEF / MAGERITEN





REF	Forma	Fig	Ø mm	H mm	ml	
P859.143		24	24	27,0	70	1



FLORES / FLOWERS / FLEURS / BLUMEN







REF	Forma	Fig	Ø mm	H mm	ml	
P859.144		24	78	20,0	80	1



PIRÁMIDES / PYRAMIDS / PYRAMIDES / PYRAMIDEN









REF	Forma	Fig	mm	H mm	ml	
P859.109		54	35 x 35	23,0	15	1
P859.111		35	50 x 50	35,0	35	1
P859.110		24	71 x 71	41,0	90	1



SEMI-ESFERAS / HALF-SPHERES / DEMI-SPHÈRES / HALBKUGELN



REF	Forma	Fig	mm	H mm	ml	
P859.151		96	26	16,0	6	1
P859.105		70	29	18,0	10	1
P859.103		48	42	21,0	20	1
P859.102		28	58	31,0	50	1
P859.101		24	70	40,0	105	1
P859.104		24	80	40,0	126	1



SEMI-ESFERAS INVERTIDAS / HALF-SPHERES UPSIDE DOWN / DEMI-SPHÈRES INVERSÈES / UMGEKEHRTE HALBKUGELN





REF	Forma	Fig	mm	H mm	ml	
P859.150		45	26	16,0	6	1



CUADRADOS / SQUARES / CARRÉS / QUADRATE





REF	Forma	Fig	mm	H mm	ml	
P859.152		60	37 x 37	17,0	18	1
P859.153		35	56 x 56	24,0	60	1



TARTELETAS CUADRADAS / SQUARE TARTLET / TARTELETTES CARRÉES / QUADRATISCHE TÖRTCHEN







REF	Forma	Fig	mm	H mm	ml	
P859.154		60	45 x 45	12,0	20	1
P859.155		40	60 x 60	15,0	40	1



SAVARINS CUADRADAS / SQUARE SAVARINS / SAVARINS CARRÉES / QUADRATISCHE SAVARINE







REF	Forma	Fig	mm	H mm	ml	
P859.156		60	37 x 37	17,0	15	1
P859.157		35	56 x 56	24,0	45	1
P859.158		24	70 x 70	30,0	100	1



SAVARINS REDONDOS / ROUND SAVARINS / SAVARINS RONDS / RUNDE SAVARINE





REF	Forma	Fig	mm	H mm	ml	
P859.159		60	41	12,0	10	1
P859.124		35	66	20,0	50	1
P859.219		24	70	23,0	65	1
P859.122		24	80	20,0	70	1



SAVARINS OVALADOS / OVAL SAVARINS / SAVARINS OVALES / OVALE SAVARINE





REF	Forma	Fig	mm	H mm	ml	
P859.123		24	80 x 60	25,0	70	1



ÓVALOS / OVAL / OVALES / OVALE





REF	Forma	Fig	mm	H mm	ml	
P859.167		30	70 x 50	30,0	75	1
P859.130		30	85 x 60	30,0	100	1



TARTELETAS OVALADAS / OVAL TARTLETS / TARTELETTES OVALES / OVALE TÖRTCHEN







REF	Forma	Fig	mm	H mm	ml	
P859.169		48	66 x 27	11,0	10	1



9.8 MOLDES FLEXIPAN / FLEXIPAN MOULDS / MOULES FLÉXIPAN / FLEXIPANFORMEN

TARTELETAS REDONDAS / ROUND TARTLETS / TARTELETTES RONDS / RUNDE TÖRTCHEN







REF	Forma	Fig	mm	H mm	ml	
P859.114		60	42	10,0	13	1
P859.171		48	48	15,0	20	1
P859.172		40	58	20,0	35	1
P859.126		24	77	20,0	65	1



TRONCOS / LOGS / BÛCHE / BLÖCKE



REF	Forma	Fig	mm	H mm	ml	
P859.125		24	95 x 40	30,0	80	1
P859.183		24	122 x 42	32,0	115	1
P859.184		8	339 x 40	39,0	450	1
P859.185		5	495 x 40	39,0	700	1



CAKES/BIZCOCHOS / CAKES-LADY FINGERS / CAKES-COUDOIRS / KUCHEN/ BISKUIT





REF	Forma	Fig	mm	H mm	ml	
P859.186		120	40 x 15	12,0	6	1



LINGOTES / LINGOTS / LINGOTS / BARREN



REF	Forma	Fig	mm	H mm	ml	
P859.189		24	100 x 40	25,0	70	1
P859.190		24	120 x 40	25,0	90	1



SEMI-CILINDROS / HALF-CYLINDRES / DEMI-CYLINDRES / HALBZYLINDER





REF	Forma	Fig	mm	H mm	ml	
P859.191		48	85 x 17	15,0	20	1



CAKES



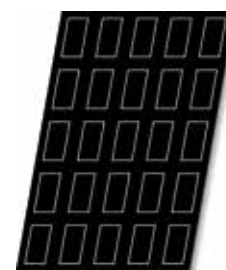

REF	Forma	Fig	mm	H mm	ml	
P859.192		24	80 x 30	30,0	55	1
P859.195		16	110 x 60	25,0	105	1



FINANCIERS







REF	Forma	Fig	mm	H mm	ml	
P859.196		84	50 x 26	11,0	10	1
P859.197		24	86 x 46	14,0	45	1



MUFFINS







REF	Forma	Fig	Ø mm	H mm	ml	
P859.106		40	51	29,0	45	1
P859.107		24	73	40,0	125	1
P859.198		15	82	50,0	220	1



CILINDROS / CYLINDERS / CYLINDRES / ZYLINDER





REF	Forma	Fig	Ø mm	H mm	ml	
P859.206		48	40	20,0	25	1
P859.207		24	63	25,0	65	1
P859.117		24	63	35,0	90	1



FLORENTINA / FLORENTINERS / FLORENTINS / FLORENTINER







REF	Forma	Fig	Ø mm	H mm	ml	
P859.129		15	102	20,0	140	1



9.8 MOLDES FLEXIPAN / FLEXIPAN MOULDS / MOULES FLÉXIPAN / FLEXIPANFORMEN

TARTAS TATIN / ETATIN APPLE TARTS / TARTES TATIN / TATINTORTEN





REF	Forma	Fig	Ø mm	H mm	ml	
P859.210		15	82	30,0	135	1
P859.211		12	100	35,0	245	1
P859.212		12	105	40,0	305	1



ENTREMETS-PIZZAS-QUICHES / ROUND-PIZZA-QUICHES / EMPREINTES RONDAS-PIZZA-QUICHES / VORSPEISE-PIZZA-QUICHES





REF	Forma	Fig	Ø mm	H mm	ml	
P859.116		6	186	12,0	300	1



CUCHARAS / SPOONS / CUILLÈRES / LÖFFEL





REF	Forma	Fig	mm	H mm	ml	
P859.174		36	90 x 28	12,0	15	1



LANZADERAS / MINI-BRIOCHES / NAVETTES / SCHIFFCHEN





REF	Forma	Fig	mm	H mm	ml	
P859.200		48	70 x 30	10,0	15	1



ALARGADAS / LONG / LONGUES / LANGE





REF	Forma	Fig	mm	H mm	ml	
P859.201		24	130 x 48	18,0	80	1



REDONDAS / ROUNDS / ROUNDS / RUNDE





REF	Forma	Fig	Ø mm	H mm	ml	
P859.202		24	79	15,0	65	1



FLORES / FLOWERS / FLEURS / BLUMEN







REF	Forma	Fig	mm	H mm	ml	
P859.203		24	62 x 49	26,0	60	1



ACANALDA / CANNELÉES / CANNELÉES / RUNDE ECKEN





REF	Forma	Fig	Ø mm	H mm	ml	
P859.204		24	68	25,0	60	1
P859.205		24	78	30,0	105	1
P859.112		24	81	37,0	105	1



OCTÁGONOS / OCTAGONS / OCTAGONES / ACHTECKE





REF	Forma	Fig	mm	H mm	ml	
P859.119		40	43 x 40	26,0	28	1



MEDALLONES / MEDAILLONS / MÉDAILLONS / MEDAILLEN





REF	Forma	Fig	Ø mm	H mm	ml	
P859.179		96	28	8,0	5	1



POMPONNETTES / POMPONNETTES / POMPONNETTES / POMPONNETTES





REF	Forma	Fig	Ø mm	H mm	ml	
P859.120		96	36	17,0	14	1



POMPONNETTES / POMPONNETTES / POMPONNETTES / POMPONNETTES



REF	Forma	Fig	Ø mm	H mm	ml	
P859.121		54	40	20,0	22	1





10.1 COCCIÓN / COOKING / COUSSION / KÜCHENMACHINEN 284

PLACAS INDUCCIÓN / INDUCTION UNITS / PLAQUE INDUCTION / INDUKTIONSEPLATTEN	286
PLACAS INDUCCIÓN MANTENEDORAS / WARMING INDUCTION UNITS / PLAQUE INDUCTION DE MAINTIEN TEMPÉRATURE/ WARMHALTE-INDUKTIONSPLATTE	289
FREIDORAS / FRYEIRS / FRITEUSES / FRITEUSEN	293
HORNOS Y MICRO-ONDAS / OVENS & MICRO-WAVES / FOURS ET MICRO-ONDES / OFEN UND MIKROWELLEN	295
CREPERA & GOFRERA / CREPE & WAFFLE EQUIPMENT / CRÉPIÈRE & GAUFRIER / CREPES & WAFFEL	297

10.2 TOSTADORAS Y GRILL DE CONTACTO / TOASTEURS & CONTACT GRILLS / TOASTER ET GRILL DE CONTACT / TOASTER - KONTACKGRILL 298

TOSTADORAS / TOASTERS / TOASTEURS / TOASTER	298
GRILL DE CONTACTO / CONTACT GRILL / GRILL DE CONTACT / KONTAKTGRILL	304

10.3 PROCESADORES DE ALIMENTOS / FOOD PROCESSORS / ROBOTS MULTIFONCTION / LEBENSMITTELMASCHINE 305

BATIDORAS PLANETARIAS / MIXERS / MÉLANGEURS / MIXERS	306
CORTA FIAMBRES / SLICING MACHINES / TRANCHEURS / AUFSCHNITTMASCHINE	307
BRAZOS TRITURADORES / STICK BLENDERS / BRAS MIXEURS / MIXER	308
BATIDORAS / BLENDERS / MIXEURS/ MIXER	311

10.4 MAQUINARIA MANTENEDORA DE TEMPERATURA / FOOD WARMING EQUIPMENT APPAREILS DE MAINTEN DE TEMPEÉRATURE / WARMHALTEMASCHINEN 323

RETERMALIZADORES / RETHERMALIZERS / APPAREIL DE REMISE EN TEMPÉRATURE / RETHERMALISIER	326
BAÑOS MARÍA / BAIN MARIE / BAIN-MARIE / WASSERBAD	330
LÁMPARAS MANTENEDORAS / HEATING LAMPS / LAMPE CHAUFFANTE / WÄRMELAMPEN	336
ARMARIOS CALIENTES / HOT BANQUET TROLLEYS / ARMOIRES CHAUDES / WARMHALTESCHRANKE	341

10.5 MAQUINARIA HELADERÍA / ICE-CREAM MACHINES / TURBINES À GLACE / EISMASCHINEN 344

PLACAS INDUCCIÓN / INDUCTION HOBS / PLAQUES INDUCTION / INDUKTIONSFELDER

LA NUEVA FORMA DE COCINAR: MÁS EFICIENTE, MÁS
RAPIDA, MÁS SEGURA Y MÁS PRECISA /

THE NEW WAY OF COOKING: MORE EFFICIENT,
FASTER, SAFER AND MORE PRECISE /

LA NOUVELLE MANIÈRE DE CUISINER : PLUS EFFICACE,
PLUS RAPIDE, PLUS SÛRE ET PLUS PRÉCISE /

DIE NEUE FORM ZU KOCHEN: EFFIZIENTER, SCHNELLER,
SICHERER UND PRÄZISER



1 RAPIDEZ / SPEED / RAPIDITÉ / SCHNELLIGKEIT

SIENDO TRANSMITIDO DIRECTAMENTE A LA OLLA,
EL CALOR, SE CONCENTRA DONDE SE NECESITA
AHORRANDO ENERGÍA Y, OBIAMENTE, TIEMPO /

AS HEAT IS DIRECTLY TRANSMITTED TO THE PAN,
IT WILL BE CONCENTRATED WHERE IT IS NEEDED,
SAVING BOTH ENERGY AND TIME /

LA CHALEUR ÉTANT TRANSMISE DIRECTEMENT À
LA CASSEROLE, ELLE SE CONCENTRE LÀ OÙ ELLE
EST NÉCESSAIRE EN ÉCONOMISANT DE L'ÉNERGIE
ET, BIEN SÛR, DU TEMPS /

DA DIE HITZE DIREKT AUF DEN TOPF ÜBERTRAGEN
WIRD DIESE KONZENTRIERT UND SO ENERGIE UND
NATÜRLICH ZEIT GESPART

2 PRECISIÓN / PRECISION / PRÉCISION / PRÄZISION

GRACIAS A SU SENSIBILIDAD, LAS PLACAS DE INDUCCIÓN
CONCEDEN AL COCINERO UNA CAPACIDAD DE CONTROL
INCOMPARABLE CON LAS COCINAS TRADICIONALES /

THANKS TO THEIR SENSIBILITY, INDUCTION HOBS GIVE THE
CHEF AN UNBEATABLE ABILITY TO CONTROL THE HEAT
WHEN COMPARED TO TRADITIONAL HOBS /

GRÂCE À LEUR SENSIBILITÉ, LES PLAQUES À INDUCTION
OFFRENT AU CUISINIER UNE CAPACITÉ DE CONTRÔLE SANS
COMPARAISON AVEC LES CUISINIÈRES TRADITIONNELLES /

DANK IHRER SENSIBILITÄT BIETEN DIE INDUKTIONSPLETTEN
DEM KOCH EINE UNVERGLEICHICHE KONTROLLE
GEGENÜBER TRADITIONELLER HERDE



COCINA DE INDUCCIÓN /
INDUCTION HOB /
CUISINIÈRE À INDUCTION /
INDUKTIONSHERD



COCINA DE GAS /
GAS HOB /
CUISINIÈRE À GAZ /
GASHERD

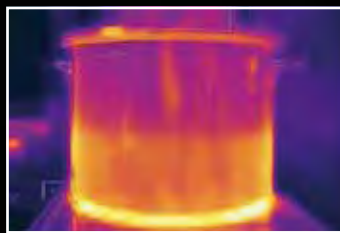

COCINA DE INDUCCIÓN /
INDUCTION HOB /
CUISINIÈRE À INDUCTION /
INDUKTIONSHERD

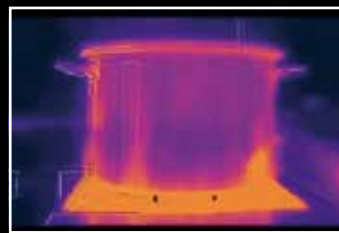

COCINA DE GAS /
GAS HOB /
CUISINIÈRE À GAZ /
GASHERD

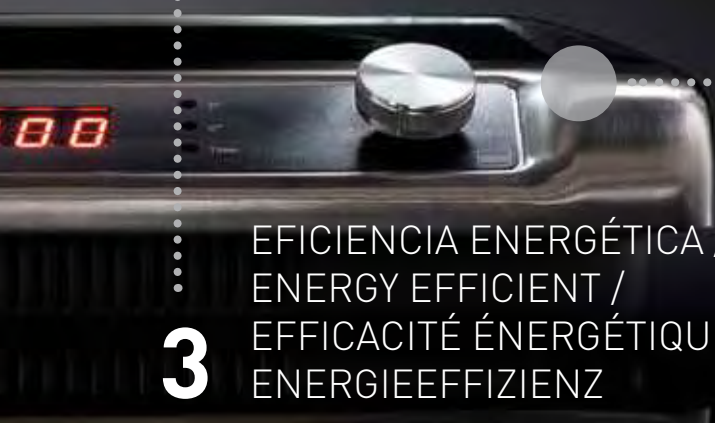

3

EFICIENCIA ENERGÉTICA / ENERGY EFFICIENT / EFFICACITÉ ÉNERGÉTIQUE / ENERGIEEFFIZIENZ

EL CAMPO ELECTROMAGNÉTICO PRODUCIDO POR LAS PLACAS DE INDUCCIÓN TRANSMITE EL CALOR DIRECTAMENTE A LA PIEZA EVITANDO LA DISPERSION DE ENERGÍA QUE SE GENERA COCINANDO CON GAS /

THE ELECTROMAGNETIC FIELD PRODUCED BY INDUCTION HOB'S TRANSMITS THE HEAT DIRECTLY TO THE PAN, AVOIDING THE DISPERSAL OF ENERGY THAT HAPPENS WHEN COOKING WITH GAS /

LE CHAMP ÉLECTROMAGNÉTIQUE PRODUIT PAR LES PLAQUES À INDUCTION TRANSMET LA CHALEUR DIRECTEMENT À LA PIÈCE EN ÉVITANT LA DÉPERDITION D'ÉNERGIE GÉNÉRÉE QUAND ON CUISINE AU GAZ /

DAS ELEKTROMAGNETISCHE FELD, DAS DURCH DIE INDIKTIONSPLATTEN ENTSTEHT, ÜBERTRÄGT DIE HITZE DIREKT AUF DEN TOPF. SO WIRD EINE HITZESTREUUNG, DIE BEI GASHERDEN AUFTRITT, VERMIEDEN

4

SEGURIDAD / SAFETY / SÉCURITÉ / SICHERHEIT

SIN UNA PIEZA ESPECIFICA QUE ACTIVE EL CAMPO MAGNÉTICO, LAS PLACAS DE INDUCCIÓN NO SE CALIENTAN /

WITHOUT ANYTHING ON THE HOB TO ACTIVATE THE MAGNETIC FIELD, THE INDUCTION HOB'S DO NOT HEAT UP /

À DÉFAUT D'UNE PIÈCE ADAPTÉE CAPABLE D'ACTIVER LE CHAMP MAGNÉTIQUE, LES PLAQUES NE CHAUFFENT PAS /

OHNE EIN SPEZIALTEIL, DAS DAS MAGNETFELD AKTIVIERT, ERWÄRMEN SICH DIE INDUKTIONSPLATTEN NICHT



mirage®

INDUCTION

100

Niveles de potencia /
 Power levels /
 Niveaux de puissance /
 Leistungsstufen

1-180 min

Temporizador /
 Timer /
 Minuterie /
 Timer

LED

Pantalla /
 Display /
 Ecran
 Display

Memoria de temperatura – permite usar el último ajuste de temperatura programado. Cuadro de selección de temperatura y potencia /
 Temperature memory — powers up to the last used temperature setting. Cutting-edge dial control with high-speed power and temperature level adjustment /

Mémoire de température – offre la possibilité d'utiliser le dernier réglage de température. Cadran de réglage avant-gardiste permettant un réglage rapide de la température et de la puissance /

Temperaturspeicher – beim Einschalten wird die zuletzt verwendete Temperatureinstellung wieder verwendet. Hochmoderne Wählscheibenbedienung mit Hochgeschwindigkeitseinstellung der Leistungs- und Temperaturstufe.

Resistente caja de acero inoxidable con superficie cerámica 100% sellada /
 Tough stainless steel case with 100% framed ceramic top for durability /
 Boîtier inox solide avec une surface supérieure à 100 % en céramique afin de garantir de une durée de vie plus longue /

Robustes Edelstahlgehäuse mit zu 100 % gerahmtem Oberteil verbessert die Haltbarkeit.



59650 Placa inducción / Induction cooker / Plaque induction / Induktionskochplatten

CE



REF	Ø Màx cm	V	W	A	ENCH. PLUG	Hz	☐
59650	36	230	1800	7,8	EU	50/60	1
59651	36	230	1800	7,8	UK	50/60	1

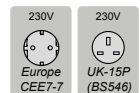

59601 Placa inducción encastrable / Drop in induction cooker / Plaque induction encastrable / Einsetzbare Induktionsplatte

CE

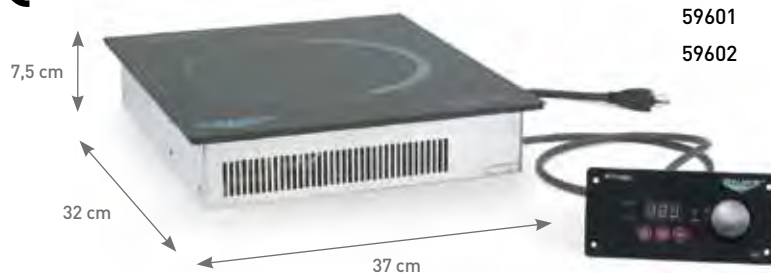

REF	Ø Màx cm	cm	V	W	A	ENCH. PLUG	Hz	☐
59601	36	34 x 30	230	1800	7,8	EU	50/60	1
59602	36	34 x 30	230	1800	7,8	UK	50/60	1

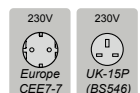

Control con ajuste de alta velocidad para nivel de potencia y temperatura. Cuerpo resistente de acero inoxidable con superficie cerámica. Memoria de temperatura, permite utilizar el último ajuste de temperatura usado.

Cutting-edge dial control with high-speed power and temperature level adjustment. Tough stainless steel case with 100% framed ceramic top for durability. Temperature memory — powers up to the last used temperature setting.

Cadran de réglage à la pointe de la technique permettant le réglage rapide de la température et de la puissance. Boîtier inox solide avec dessus 100 % céramique pour plus de durabilité. Mémoire de température – monte au dernier réglage de empérature utilisé.

Hochmoderne Wählscheibenbedienung mit Hochgeschwindigkeitseinstellung der Leistungs- und Temperaturstufe. Robustes Edelstahlgehäuse mit zu 100 % gerahmtem Oberteil verbessert die Haltbarkeit. Temperaturspeicher – beim Einschalten wird die zuletzt verwendete Temperatureinstellung wieder verwendet.

69543 Placa inducción / Induction cooker / Plaque induction / Induktionskochplatten



REF	Ø M _{ax} cm	V	W	A	ENCH. PLUG	Hz	
6954302	36	208-240	2600	10,8	EU	50/60	1
6954303	36	208-240	2600	10,8	UK	50/60	1

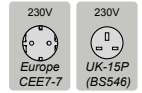

69505 Placa inducción encastrable / Drop in induction cooker /
 Plaque induction encastrable / Einsetzbare Induktionskochplatten

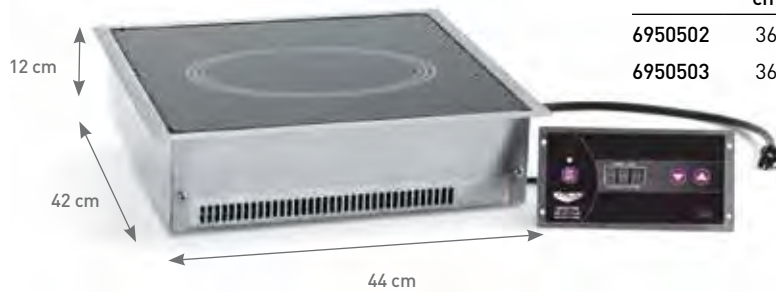

REF	Ø M _{ax} cm	V	W	A	ENCH. PLUG	Hz	
6950502	36	240	3000	14,6	EU	50/60	1
6950503	36	240	3000	14,6	UK	50/60	1

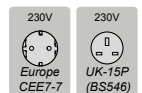

69547 Placa inducción doble / Double induction plate / Plaque à induction double / Doppel-Induktionskochplatte



REF	Ø cm	V	W	A	ENCH. PLUG	Hz	
6954702	30 x 2	208-240	3800	15,8	EU	50/60	1
6954703	30 x 2	208-240	3800	15,8	UK	50/60	1

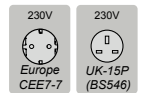

Placas inducción estándar / Standard Induction /
 Plaque induction standard / Induktionsplatten standard

P688065 Placa de inducción wok / Wok induction cooker / Plaque à induction wok / Induktionskochfeld wok



REF	Ø cm	V	W	Hz	ENCH. PLUG	Hz	
P688.065	36/40	220-240	3100	50	EU	50/60	1

Cuerpo en acero inoxidable. Reloj temporizador (0-180 minutos). Pantalla LED. Temperatura 60-240 °C. 4 ventiladores.

Corps en acier inoxydable. Minuteur (0-180 minutes). Ecran LED. Températures: 60-240 °C. 4 ventilateurs.

St/steel housing. Timer (0-180 minutes). LED display. Temperatures: 60-240 °C. 4 fans.

Gehäuse aus rostfreiem Stahl. Timer (0-180 Minuten). LED Display. Temperaturbereich von 60-240 °C. 4 Kühlventilatoren.



WOKS P. 52, 57

P15078 Placa de inducción / Induction cooker / Plaque à induction / Induktionskochfeld



REF	Ø Màx cm	V	W	Hz	
P15.078	26	220 - 240	3500	50/60	1

Cuerpo en acero inoxidable. Reloj temporizador (0-180 minutos). Pantalla LED con control táctil. Regulador de temperatura 1-10 (500-3500W). Rango temperatura 60-240 °C. Cuatro ventiladores de refrigeración.

St/steel housing. Timer. LED display (0-180 minutes). Touch control. 1-10 Power level (500-3500W). Temperatures: 60-240 °C. Four fans.

Corps en acier inoxydable. Minuteur. Ecran LED (0-180 minutes). Tactile. 1-10 Niveau de puissance (500-3500W). Temperatures: 60-240 °C. Quatre ventilateurs.

Gehäuse aus rostfreiem Stahl. Timer. Timer (0-180 Minuten). LED Display mit Touch control. Temperaturregler 1-10 (500-3500W). Temperaturbereich von 60-240 °C. 4 Kühlventilatoren.

P15072 Placa de inducción / Induction cooker / Plaque à induction / Induktionskochfeld

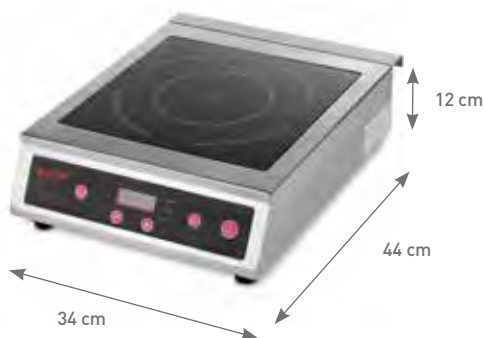

REF	Ø Màx cm	V	W	Hz	
P15.072	26	230	3500	50/60	1

Cuerpo en acero inoxidable. Mando digital de tiempo de 0-180 minutos. Temperatura de 60-240 °C. Potencia de 500-3500 W. 4 Ventiladores.

St/Steel housing. Digital regulation of time 0-180 minutes, thermostat 60-240 °C and power 500-3500 W. 4 Fans.

Corps en acier inoxydable. Minuterie digitale de 0-180 minutes. Température de 60-240 °C. Puissance: 500-3500 W. 4 Ventilateurs.

Gehäuse aus rostfreiem Stahl. Digitale Timersteuerung von 0-180 Minuten. Temperatur von 60-240 °C. Leistung von 500-3500 W. 4 Kühlventilatoren.

P15079 Placa de inducción / Induction cooker / Plaque à induction / Induktionskochfeld



REF	Ø Màx cm	V	W	Hz	
P15.079	26	230	3500	50/60	1

Cuerpo en acero inoxidable. Reloj temporizador (0-180 minutos). Pantalla LED. Rango temperatura 60-240 °C. Un ventilador de refrigeración.

St/steel housing. Timer. LED display (0-180 minutes). Temperatures: 60-240 °C. One fan.

Corps en acier inoxydable. Minuteur. Ecran LED (0-180 minutes). Temperatures: 60-240 °C. Un ventilateur.

Gehäuse aus rostfreiem Stahl. Timer von 0-180 Minuten. LED Display. Temperaturbereich von 60-240 °C. 1 Kühlventilator.

P15077 Placa de inducción pequeña / Induction cooker / Plaque induction petite / Kleines induktionskochfeld



REF	Ø Màx cm	V	W	Hz	
P15.077	26	230	2000	50/60	1

Cuerpo en plástico. Con panel control táctil LC D. Reloj temporizador (0-180 minutos). Rango temperaturas: 60-240 °C.

Plastic housing with touch control LCD panel. Timer (0-180 minutes). Temperatures: 60-240 °C.

Corps en plastique avec écran LCD tactile. Minuteur (0-180 minutes). Temperatures: 60-240 °C.

Gehäuse aus Plastik. Touch Control LCD Bildschirm. Timer (0-180 Minuten). Temperaturbereich von 60-240 °C.

MIRAGE®

INDUCTION

BUFET CALENTADORES INDUCCIÓN / BUFFET INDUCTION WARMER / BUFFET RECHAUD INDUCTION / BÜFFET-INDUKTIONS-RECHAUD

Mantener la comida caliente durante el servicio.
Low wattage to keep food warm during serving.
Faible puissance pour garder les aliments au chaud pendant le service.
Geringer Wattverbrauch zum Warmhalten der Speisen beim Servieren.

Parte superior de cristal templado negro.
Tempered, black glass top.
Plateau en verre noir trempé.
Haube aus schwarzem gehärtetem Glas.

Con 4 ajustes de potencia. Indicadores luminosos LED en el panel de control.
Touch control, 4 power settings. LED indicator lights on control panel & glass.
Contrôle tactile, 4 réglages de puissance. Voyants LED lumineux sur le panneau de commande et verre.
Touch Control mit 4 Stufen. LED-Anzeigeleuchten auf Steuerpanel und Glas.

Conecte hasta 3 placas a la vez.
Connect up to 3 units together with interconnect cords.
Connectez jusqu'à 3 unités avec des cordons d'interconnexion.
Schließen Sie bis zu 3 Geräte mit einer Weiterverbindungs-Geräteanschlussleitung an.



595027502 Placa inducción mantenedora de temperatura / Buffet induction warmer / Plaque induction de maintien température / Warmhalte-Induktionsplatte



REF	mm	VOLT. CA / AC	W	A	ENCH. PLUG	Hz	
595027502	400 x 400 x 80	230	300	1,30	EU	50/60	1
595027503	400 x 400 x 80	230	300	1,30	UK	50/60	1
595087502	600 x 400 x 80	230	375	1,63	EU	50/60	1
595087503	600 x 400 x 80	230	375	1,63	UK	50/60	1



595087502
595087503



595027502
595027503

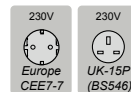

10.1 MANTENEDORES DE TEMPERATURA / WARMING EQUIPMENT / MAINTENANCE DE TEMPÉRATURE / WARMHALTEMASCHINEN



59641 Placa inducción mantenedora de temperatura encastrable / Drop in warmer / Plaque induction de maintien température encastrable / Einsetzbare Warmhalte-Induktionsplatte



REF	Ø MÁX cm	cm*	VOLT. CA / AC	W	A	ENCH. PLUG	Hz	
59641	36	34 x 30	230	650	2,8	EU	50/60	1
59642	36	34 x 30	230	650	2,8	UK	50/60	1

* Encastrable / Drop in / Encastrable / Einsetzbare

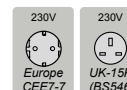

Placa de inducción encastrable 59641 + encimera de diseño / Drop-in induction plate 59641 + design countertop Plaque à induction encastrable 59641 + plan de conception / Einbau-Kochplatte 59641 + Design-Arbeitsplatte



Negro / Black / Noir / Schwarz



Granito / Granite / Granite / Granit



Crema / Cream / Crème / Creme



Blanco / White / Blanc / Weiß

REF	Nº PLACA / WARMER / PLAQUE / PLATTE	cm	ESPEJOR / THICKNESS / EPAISSEUR / DICKE mm	ENCH. PLUG	
59608201	1	45,7 x 61	4	EU	1
59608451	1	45,7 x 61	4	EU	1
59608351	1	45,7 x 61	4	EU	1
59608101	1	45,7 x 61	4	EU	1
59609201	2	91,4 x 61	4	EU	1
59609451	2	91,4 x 61	4	EU	1
59609351	2	91,4 x 61	4	EU	1
59609101	2	91,4 x 61	4	EU	1

UK: Llame a su representante de ventas para obtener el numero de articulo correcto.
Los juegos incluyen placas de inducción y plantillas aptas para inducción.

UK: Call your sales rep for the correct item number.
The kits includes Drop-in warmer and glass template.

UK: Contactez le service commercial pour obtenir la reference de l'article.
Les Kits incluent des rechauds a induction et des gabarits speciaux induction.

UK: Rufen Sie Ihren zustandigen Vertriebspartner fur korrekten Artikelnummern.
Diese Kits beinhalten induktionswärmer und induktionsgeeignete Schablonen.

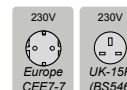



MAQUINARIA /
EQUIPMENT /
EQUIPMENT

Plantilla apta para inducción /
Template special induction /
Gabarit speciaux induction /
Induktionsgeeignete Schablonen

Mesa /
Table /
Table /
Tafel

Placa inducción encastrable /
Drop in warmer /
Plaque induction encastrable /
Einsetzbare Induktionsplatte





Freidoras equipadas con un termostato EGO, un termostato de seguridad, luces piloto indicadoras y zona fría.

Las unidades de calentamiento se quitan y ponen fácilmente para facilitar la limpieza. Temperatura variable hasta 190 °C.

Las cubas llevan asas entrantes móviles (15070, 15071, 15000, 15001).

The deep fat fryers equipped with EGO thermostat, thermal cut-out, indicator lights, cold zone.

The heating unit is easily removable and thus facilitating maintenance and cleaning.

Variable temperature control up to 190 °C.

Removable inner pan with recessed handles (15070, 15071, 15000, 15001).

Les friteuses sont équipées d'un thermostat EGO, un thermostat de sécurité, des voyants lumineux et une zone froide.

Resistance amovible pour faciliter le nettoyage. Température variable jusqu'à 190 °C.

Les cuves, avec anses pliables, sont amovibles (15070, 15071, 15000, 15001).

Fritteuse hergestellt ausgestattet mit EGO-Thermostat, ein Sicherheitsthermostat, Kontrolllichter und kalte Zone.

Zur besseren Reinigung lassen sich die Hitzelemente einfach herausnehmen und zusammenbauen.

Variable Temperatur bis 190 °C.

Die Frittierkörbe werden mit abnehmbaren Griffen geliefert (15070, 15071, 15000, 15001).

P15070 Freidora 5 lts / 5 lts fryer /
Friteuse 5 lts / 5 Liter Fritteuse

INOX - ST/STEEL
EDELSTAHL
18/10



REF	Lts	V	W	Hz	
P15.070	5,00	230	2000	50/60	1

Medida cesta / Basket size / Mesure panier / Frittierkorbgröße 21 x 14 x 12,5 cm

P15071 Freidora 5+5 lts / 5+5 lts fryer /
Friteuse 5+5 lts / 5+5 Liter Fritteuse

INOX - ST/STEEL
EDELSTAHL
18/10



REF	Lts	V	W	Hz	
P15.071	5,00+5,00	2 x 230	2 x 2000	50/60	1

Medida cesta / Basket size / Mesure panier / Frittierkorbgröße 21 x 14 x 12,5 cm

P15000 Freidora 8 Lts / 8 Lts Fryer /
Friteuse 8 Lts / 8 Liter Fritteuse

INOX - ST/STEEL
EDELSTAHL
18/10



REF	Lts	V	W	Hz	
P15.000	8,00	230	3250	50/60	1

Medida cesta / Basket size / Mesure panier / Frittierkorbgröße 24 x 18 x 14 cm

P15001 Freidora 8+8 Lts / 8+8 Lts Fryer /
Friteuse 8+8 Lts / 8+8 Liter Fritteuse

INOX - ST/STEEL
EDELSTAHL
18/10



REF	Lts	V	W	Hz	
P15.001	8,00+8,00	2 x 230	2 x 3250	50/60	1

Medida cesta / Basket size / Mesure panier / Frittierkorbgröße 24 x 18 x 14 cm

P15002 Freidora 8 Lts con grifo de vaciado /
8 Lts fryer with drainage tap /
Friteuse 8 Lts avec robinet vidange /
8 Liter Fritteuse mit Ablaufhahn

INOX - ST/STEEL
EDELSTAHL
18/10



REF	Lts	V	W	Hz	
P15.002	8,00	230	3250	50/60	1

Medida cesta / Basket size / Mesure panier / Frittierkorbgröße 24 x 18 x 14 cm

P15003 Freidora 8+8 Lts con grifo de vaciado /
8+8 Lts fryer with drainage tap /
Friteuse 8+8 Lts avec robinet vidange /
8+8 Liter Fritteuse mit Ablaufhahn

INOX - ST/STEEL
EDELSTAHL
18/10



REF	Lts	V	W	Hz	
P15.003	8,00+8,00	2 x 230	2 x 3250	50/60	1

Medida cesta / Basket size / Mesure panier / Frittierkorbgröße 24 x 18 x 14 cm



P688010 Microondas profesional "magnetron" / "magnetron" professional micro - waves /
Four micro - ondes professionnel "magnetron" / Professionelle "magnetron" Mikrowelle



OUTPUT 1800 W

INOX - ST/STEEL
EDELSTAHL



REF	Lts	Kg	DIM INT / INNER SIZES / DIM. INT. / INNENMASSE cm	V	W	Hz	
P688.010	30,00	35	39 x 37 x 19	230	2.800	50	1

**2 magnetrones / 2 magnetrons /
2 magnétrons / 2 Magnetrones**

**10 Programas. 3 Velocidades. Programa descongelación
10 Program options. 3 Speeds. Defrost system
10 Programmes. 3 Puissances. Décongélation
10 verschiedenen Programmen. Drei Geschwindigkeiten**

Contiene / Contents / Livré:

Fuente cerámica + bandeja 39x37 cm
Ceramic plate + tray of 39x37 cm
Plaque céramique + plaque 39x37 cm
Keramische Platte +Zwischentablett von 39x37 cm.

WM090E Microondas / Micro-waves / Micro-ondes / Mikrowelle



INOX - ST/STEEL
EDELSTAHL



REF	Lts	DIM INT / INNER SIZES / DIM. INT. / INNENMASSE cm	V	W	Hz	
WM090E	25,00	31 x 30 x 20	220-240	1.000	50	1

Output / Ausgangsleistung: 1.000 W

10 botones programables. 100 programas distintos. 3 tipos de cocinado. 5 niveles de potencia. Operaciones programables y manuales. Botones táctiles con Braille. Luz interior. Tiempo máx. de cocción: 60 minutos.	10 boutons programmables. 100 mémoires de capacité. 3 types de cuisson. 5 niveaux de puissance. Opérations programmables et manuelles. Boutons tactiles avec braille. Lumière intérieure. 60 minutes: Temps max. de cuisson.
10 programmable memory pads. 100 memory capability. 3-stage cooking. 5 power levels. Programmable and manual operations. Touch control keypad with Braille. Interior oven light. 60-minute max cook time.	10 programmierbare Tastknöpfe. 100 Kapazitätsspeicher. 3 Kocharten. 5 Leistungsstufen. Programmierbare und manuelle Operationen. Tastknöpfe auf Braille. Innenbeleuchtung. Maximale Kochzeit: 60 Minuten.

P15080 Microondas combi / Combi micro - wave / Four micro - ondes / Kombi - Mikrowelle

**NUEVO MODELO /
NEW MODEL /
NOUVEAU MODÈLE /
NEUES MODELL**



REF	Lts	Dim int / Inner sizes / Dim. int. / Innenmasse cm	V	Max W	Hz	
P15.080	25,0	33,5 x 33,5 x 17	230	1.950	50	1

Input: 1.400 W
Output: 900 W
Grill: 1.950 W
Convección / Convection / Konvektion: 1.950 W

Ø plato giratorio / glass round dish /
Plateau tournant / Drehplatte 27 cm

Funciones: descongelar, gratinar y calentar
Funcions: décongeler, grattiner et chauffer
Funktionen: Auftauen, überbacken und erhitzen

10

Niveles de potencia / Power levels /
Niveaux de puissance / Leistungsstufen

P15035 Horno multifuncional de convección / Convection oven /
Four à air pulse / Multifunktioneller Konvektionsbackofen



REF	REJILLA / GRILL / GRILLE / ROST	V	W	
P15.035	43 x 32	230	2.670	1

4 rejillas incluidas / 4 grids included / 4 grilles incluses / 4 Roste inklusive

Temporizador, pilotos luminosos, termostato (max. 300 °C), termostato de seguridad y doble vidrio anti-quemaduras.

Avec minuterie, voyants lumineux, thermostat (max. 300 °C), thermostat de sécurité et avec double vitre. mostat, thermostat de sécurité et avec vitre double.

Timer, indicator lights, thermostat, (max. 300 °C) thermal cut-out and double glass.

Timer, Kontrollleuchten, Thermostat (max. 300 °C), Sicherheitsthermostat und Doppelglas gegen Verbrennungen.

P688085 Hervidor de arroz / Rice cooker / Cuiseur à riz / Reiskocher



REF	Ø cm	CAPACIDAD ARROZ / RICE CAPACITY / RIZ CAPACITE / REIS KAPAZITÄT KG	Lts	H cm	V	W	Hz	
P688.085	46	3,0	5,40	40	220-230	1.950	50/60	1
P688.087	56	6,1	8,20	40	220-240	2.500	50/60	1



Ref: P688.085



Ref: P688.087

P15036 Salamandra con parte superior regulable / Salamander with adjustable top /
Salamandre hauteur réglable / Salamander mit regulierbarem Oberteil



INOX - ST/STEEL
EDELSTAHL
18/10



REF	Grill cm	V	W	Hz	
P15.036	44 x 33	230	3.000	50/60	1

Con bandeja limpieza, rejilla cromada móvil y regulador de temperatura /

Avec tiroir de propreté, grille chromée amovible et régulateur de temperature

With dripping tray, heavy chrome-plated grid and adjustable temperature switch /

Mit Reinigungsblech, herausnehmbaren Chromrost und Temperaturregler.

P15075 Crêpera / Crêpe maker / Crêpière / Crêpe

Termostato / Thermostat / Thermostat / Thermostat :
 Temp. Max 300 °C



REF	Ø cm	cm	V	W	Hz	Icon
P15.075	40	45 x 49	230	3000	50/60	1

Acero inoxidable con planchas de hierro fundido teflonadas. Indicador temperatura, cajón y espátula.

Acier inoxydable avec plaques en fonte avec revêtement en téflon. Témoin de controle, tiroir/plaque chauffante et étaleur de pâte.

St/Steel with cast iron teflon coated plates. Indicator light, drawer/warming tray and batter spreader.

Rostfreier Stahl und Platten aus Teflon- Gusseisen. Temperaturanzeige, Schublade und Spachtel.

WW180E / WW200E

Gofrera profesional / Heavy - duty waffle maker / Gaufrier professionnelle / Professionelles Waffeleisen



Ø 18 cm / H 2,5 cm
 Gofre / Waffle /
 Gaufre / Waffel

REF	Cap. Max.	Max. U DÍA / DAY / JOURNÉE / TAG	TIPO / TYPE	Ø cm	V	W	Hz	Icon
WW180E	25 u/h	100	sencilla/ single	19,5	230	1.200	50/60	1
WW200E	50 u/h	200	doble/ double	19,5 x 2	230	1.400	50/60	1

Ref. WW180E



Moldes con triple capa antiadherente, para retirar fácilmente los gofres y limpiar rápidamente el aparato.

Plaques à triple revêtement antiadhésif, pour retirer facilement les gaufres et nettoyer rapidement.

Triple-coated nonstick plates allow for easy removal of waffle and quick cleanup.

Formen mit dreifacher Antihaftbeschichtung, um die Waffeln einfach abzulösen und für eine einfache und schnelle Reinigung.

WWCM180E

Máquina profesional para hacer conos de galleta / Professional machine for making waffle cones / Machine professionnelle pour faire des cônes en biscuit / Gewerbliche Maschine zur Herstellung von Waffeltüten



3 mm
 Espesor conos galleta / Waffle cones thickness /
 Epaisseur cônes biscuit / Waffeltüten dicke

REF	Cap. Max.	Tipo/Type	Ø cm	V	W	Hz	Icon
WWCM180E	60 u/h	sencilla/ single	19	230	1200	50/60	1



Ref. CAC121

INCLUIDO / INCLUDED /
 INCLUS / INKLUSIV



Resistente base de fundición. Placas con triple capa antiadherente. Indicadores de "encendido", "listo para cocer" y "listo para comer".

Résistant base en fonte. Plaques à triple couche anti-adhérente. Voyants "allumage", "prêt à cuire" et "prêt à manger".

Durable cast-iron base. Plates with triple non-stick layer. "Power on", "ready to cook" and "ready to eat" indicators.

Solides Gusseisengestell. Dreifach antihaftbeschichtete Platten Signalleuchten: "ein", "kochbereit" und "gar/essfertig".



**Ahorre hasta un 75% de energía* /
Save up to 75% energy* /
Économisez jusqu'à 75% d'énergie*
Sparen Sie bis zu 75% Energie***

**TOSTADORAS CON
CORREA TRANSPORTADORA**

La convección forzada y las resistencias de cuarzo energéticamente eficientes brindan un tostado uniforme y rápido.

*La función en Stand by permite ahorrar un 75% de energía en el momento de baja demanda.

GRILLE-PAIN CONVOYEURS

La convection forcée et les résistances à quartz énergétiquement efficaces offrent un grillage uniforme et rapide.

*La fonction Stand by permet d'économiser 75% d'énergie aux moments de faible demande.

CONVEYOR TOASTERS

Forced convection and energy-efficient quartz resistors provide a uniform and fast toasting.

* The Stand by function saves 75% of energy during periods of low demand.

DURCHLAUFSTOASTER

Durch die erzwungene Konvektion und die energieeffizienten Quarzwiderstände kann eine gleichförmige und schnelle Bräunung erreicht werden.

* Die Stand by-Funktion spart 75% Energie für Momente mit geringerer Nachfrage.

CT4-3600W Tostadora continua / Conveyor toaster / Grille - pain à convoyeur / Durchlaufstoaster

**INOX - ST/STEEL
EDELSTAHL**

REF	V	W	Hz	A	cm	H cm	
CT4-2301000	230	3.600	50/60	15	35 x 46	60	1



Dispone de control de velocidad y temperatura.
Resistencias de cuarzo recambiables.

Speed and temperature control.
Replaceable quartz resistance.

Avec contrôle de la vitesse et température.
Résistances à quartz remplaçables.

Geschwindigkeits- und Temperaturregung.
Austauschbare Quarzwiderstände.

1.000
Rebanadas por hora /
Slices per hour /
Tranches heure /
Scheiben pro Stunde

Entregado sin clavija.
Delivered without plug (stripped ends).
Livré sans prise.
Lieferung ohne Stecker.

CT4-2800W Tostadora continua / Conveyor toaster / Grille - pain à convoyeur / Durchlaufstoaster

**INOX - ST/STEEL
EDELSTAHL**

REF	V	W	Hz	A	cm	H cm	ENCH. PLUG	
CT4-23080002	230	2.800	50/60	12,7	35 x 36	60	EU	1
CT4-23080003	230	2.800	50/60	12,7	35 x 36	60	UK	1



Dispone de control de velocidad y temperatura.
Resistencias de cuarzo recambiables.

Speed and temperature control.
Replaceable quartz resistance.

Avec contrôle de la vitesse et température.
Résistances à quartz remplaçables.

Geschwindigkeits- und Temperaturregung.
Austauschbare Quarzwiderstände.

450-800
Rebanadas por hora /
Slices per hour /
Tranches heure /
Scheiben pro Stunde

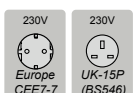

CT2-1500W Tostadora continua / Conveyor toaster / Grille - pain à convoyeur / Durchlaufstoaster

INOX - ST/STEEL
EDELSTAHL

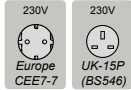

REF	V	W	Hz	A	cm	H cm	ENCH. PLUG	
CT2-23035002	230	1.500	50/60	12,5	35 x 36	41	EU	1
CT2-23035003	230	1.500	50/60	12,5	35 x 36	41	UK	1

Dispone de control de velocidad.
Resistencias de cuarzo recambiables.

Speed control.
Replaceable quartz resistance.

Avec contrôle de la vitesse.
Résistances à quartz remplaçables.

Geschwindigkeitssteuerung.
Austauschbare Quarzwiderstände.

350
Rebanadas por hora /
Slices per hour /
Tranches heure /
Scheiben pro Stunde

HORNO CINTA / CONVEYOR HEATING OVEN / FOUR CHAUFFANT À BANDE / FÖRDERBAND-AUFWÄRMOFEN

Diseñado para calentar cualquier tipo de snack y fundir queso de manera rápida y eficiente. Fabricado en acero inoxidable con un sistema de control de la velocidad variable y control de temperatura tanto por encima como por debajo de la cinta. Incluye bandeja para recoger migas. Su sistema de convección forzada y la posibilidad de regular la altura de la cinta, aseguran un tostado uniforme y la mayor eficiencia energética. Pueden remontarse dos unidades al mismo tiempo con un accesorio para ahorrar espacio.

Designed to heat any type of snack and melt cheese quickly and efficiently. Made of stainless steel with a variable speed control system and temperature control both above and below the conveyor belt. It includes a crumb collection tray. It has a forced convection system and has the possibility of regulating the height of the belt, ensuring uniform toasting and the highest energy efficiency. Two units can be mounted one top of the other with a space-saving accessory.

Conçue pour préparer toute sorte de snack et faire fondre le fromage rapidement et efficacement. Fabriqué en acier inoxydable avec un système de contrôle de vitesse variable et un contrôle de température au-dessus comme en-dessous de la bande. Inclut bac de récupération de miettes. Son système de convection forcée et la possibilité de régler la hauteur de la bande, assurent un grillé uniforme et la meilleure efficacité énergétique. Il est possible de remonter deux unités à la fois avec un accessoire pour économiser de l'espace.

Zum Erwärmen von Snacks aller Art und zum Schmelzen von Käse auf eine schnelle und effiziente Weise. Hergestellt aus rostfreiem Edelstahl mit Geschwindigkeits- und Temperatur-Steuervorrichtung sowohl oberhalb als auch unterhalb des Förderbands. Enthält Krümelauffangschale. Durch sein Umluftsystem und die Möglichkeit, die Bandhöhe einzustellen, werden eine gleichmäßige Bräunung und eine höhere Energieeffizienz sichergestellt. Um Platz zu sparen, können mit einem Zubehörteil zwei Geräte gleichzeitig montiert werden.

S02-2800W Horno calentador de cinta / Conveyor heating oven / Four chauffant à bande / Förderband-Aufwärmofen

INOX - ST/STEEL
EDELSTAHL

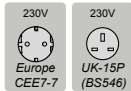

REF	V	W	Hz	A	cm	H cm	ENCH. PLUG	
S02-23010.5	230	2800	50	13,3	34 x 104	41	EU	1

26,7 cm
Ancho de cinta / Belt width /
Largeur de la bande / Bandbreite

3,8 - 7,6 cm
Altura entrada ajustable /
Adjustable entrance height /
Hauteur de l'entrée réglable /
Einstellbare Eintrittshöhe

S02-3600W Horno calentador de cinta / Conveyor heating oven / Four chauffant à bande / Förderband-Aufwärmofen

INOX - ST/STEEL
EDELSTAHL

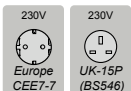

REF	V	W	Hz	A	cm	H cm	ENCH. PLUG	
S02-23014.5	230	3600	50	13,3	39 x 103,5	51	EU	1

36,8 cm
Ancho de cinta / Belt width /
Largeur de la bande / Bandbreite

3,8 - 7,6 cm
Altura entrada ajustable /
Adjustable entrance height /
Hauteur de l'entrée réglable /
Einstellbare Eintrittshöhe

Tostadoras Estándar / Standard Toasters /
Toasteurs Standard / Toasters Standard

P15042 Tostadora continua / Conveyor toaster / Toasteur convoyeur / Durchlauftoaster

INOX - ST/STEEL
EDELSTAHL

500
Rebanadas por hora /
Slices per hour /
Tranches heure /
Scheiben pro Stunde



REF	V	W	Hz	
P15.042	230	2.240	50/60	1



El color de las tostadas puede determinarse por la velocidad de la banda transportadora, así como por las resistencias superior e inferior que se controlan independientemente. El aparato está completamente aislado para que emita un calor mínimo a su alrededor. El interruptor encendido-apagado contempla la posición extra de standby. La longitud de la banda transportadora permite 2 hileras de tostadas (tipo 200) y 3 hileras (tipo 300).

Toast colour can be determined by conveyor speed as well as by independently controlled heating elements. Units are fully insulated to emit only minimal heat to surroundings. Main switch with extra standby position. The toasters can be used for bread as well as for buns. The toasting belt is suitable for 2 rows for toast, 200 type and 3 rows, 300 type.

La couleur du pain se détermine par la vitesse de la bande de transport ainsi que par les résistances contrôlées indépendamment. Les appareils sont isolés entièrement et n'émettent qu'une chaleur minimale à la température ambiante. Interrupteur marche-arrêt qui inclut le mode veille standby. La Largeur de la bande de transport permet 2 rangées de tranches, type 200 et 3 rangées, type 300.

Die Farbe der Toasts kann durch die Geschwindigkeit des Laufbands bestimmt werden, sowie durch die oberen als auch durch die unteren Heizelemente, welche unabhängig von einander kontrolliert werden können. Das Gerät ist komplett isoliert um die Umgebungstemperatur minimal zu beeinflussen. Ein/ Aus Schalter mit extra Standby Position. Die Breite des Laufbands erlaubt 2 Toastreihen (Typ 200) y 3 Toastreihen (Typ 300).

CTS1000E Tostadora comercial de servicio pesado con transportador / Heavy - Duty Commercial Conveyor Toaster /
Grille - pain à convoyeur à usage intensif / Kommerzieller Hochleistungs - Durchlauftoaster



450
Rebanadas por hora / Slices per hour /
Tranches heure / Scheiben pro Stunde

REF	V	W	A	Hz	
CTS1000E	230	2700	11,25	50/60	1



Pre-calentamiento ultra rápido de 5 minutos.
Ancha abertura de 5 cm para tostar rebanadas gruesas y panecillos.
Modo de espera para ahorrar energía.
Transportador con velocidad variable. Permite tostar por una sola cara.

Ultra-fast, 5-minute heat-up time. Large 5 cm opening accommodates thick breads and bagels. Energy-saving standby function
Conveyor speed control to suit all toasting preferences.
Allows toasting on one side only.

Mise à température rapide (5 minutes).
Ouverture de 5 cm, pour les tranches épaisses.
Mode veille pour économiser de l'énergie.
Convoyeur à vitesse variable. Permet de griller d'un seul côté.

Ultra schnelle Vorerhitzung von 5 Minuten. Öffnungshöhe von 5 cm zum Toasten von dicken Scheiben und Brötchen. Energiesparende Standby Funktion.
Laufband mit regulierbarer Geschwindigkeit.
Einseitiger Toaster.

P15038 Tostadora / Sandwich toaster / Toasteur / Sandwichtoaster

INOX - ST/STEEL
EDELSTAHL



80-100
Rebanadas por hora /
Slices per hour /
Tranches heure /
Scheiben pro Stunde

REF	V	W	Hz	
P15.038	230	1700	50/60	1



Las resistencias se pueden controlar por separado. Con temporizador y bandeja limpieza recoge migas. 4 tubos de cuarzo.

Les résistances se contrôlent séparément. Avec minuterie, tiroir ramasse miettes et 4 tubes quartz.

Heating elements separately controllable. With timer, drip tray and quartz heating elements.

Unabhängig steuerbare Hitzestäbe. Mit Timer und reinigbarer Krümelplatte, 4 Quarzrohre.

Se entregan con 3 pinzas para sandwich /
Delivered with 3 sandwich tongs /
Livrées avec 3 pinces à sandwich /
Lieferung mit 3 Sandwichzangen

P15039 Tostadora / Sandwich toaster / Toasteur / Sandwichtoaster

INOX - ST/STEEL
EDELSTAHL



120-130
Rebanadas por hora /
Slices per hour /
Tranches heure /
Scheiben pro Stunde

REF	V	W	Hz	
P15.039	230	3000	50/60	1



2 niveles. Las resistencias funcionan por separado. Con temporizador, bandeja recoge migas. 9 tubos de cuarzo.

2 niveaux. Les résistances se contrôlent séparément. Avec minuterie, tiroir ramasse miettes et 9 tubes quartz.

2 levels. Heating elements separately controllable. With timer, drip tray and 9 quartz heating elements.

2 Ebenen. Unabhängig steuerbare Hitzestäbe. Mit Timer und reinigbarer Krümelplatte, 9 Quarzrohre.

Se entregan con 6 pinzas para sandwich /
Delivered with 6 sandwich tongs /
Livrées avec 6 pinces à sandwich /
Lieferung mit 6 Sandwichzangen

VER PRODUCTOS EN / SEE PRODUCTS ON / VOIR PRODUITS EN PAGE / SIEHE PRODUKTE IN

PINZA DE PAN DE MADERA / WOODEN BREAD SPOON /
PINCE À PAIN EN BOIS / HOLZBROTZANGE

IDEA!

Ideal para manipular las tostadas /
Ideal for handling toast /
Idéal pour manipuler le pain grillé /
Ideal zum Servieren von Toasts

P. 478



P15040 / P15041 Tostadora / Toaster / Toasteur / Toaster



**NUEVO MODELO /
NEW MODEL /
NOUVEAU MODÈLE /
NEUES MODELL**

REF	RANURAS / SLOTS / FENTES / SCHLITZE	V	W	Hz	
P15.040	4	230	1.800	50/60	1
P15.041	6	230	2.500	50/60	1

Ref. P15.040

120

Rebanadas por hora /
Slices per hour /
Tranches heure /
Scheiben pro Stunde



Fabricada en acero inoxidable.
Con conmutador ahorro energía
para decidir la cantidad de
rebanadas a tostar.
2 ó 4 (ref.15040) / 3 ó 6 (ref.15041).
Con temporizador.
Ranura: 2,5 x 14,5 x 14,5 cm.

Habillage en acier inoxydable.
Avec commutateur économiseur
pour choisir le nombre de
tranches à griller:
2 ou 4 (ref. 15040) / 3 ou 6 (ref.
15041).
Avec minuterie.
Fente: 2,5 x 14,5 x 14,5 cm.

All St/Steel construction.
With energy-saving switch to
decide how many slices to toast.
2 or 4 (ref.15040) / 3 or 6
(ref.15041).
With timer.
Slot: 2,5 x 14,5 x 14,5 cm.

Hergestellt aus rostfreiem Stahl.
Mit energiesparendem Schalter
um die Anzahl der zu toastenden
Scheiben zu bestimmen. 2 oder
4 (Art.Nr.15040) / 3 oder 6 (Art.
Nr.15041). Mit Timer.
Schlitz: 2,5 x 14,5 x 14,5 cm.

Ref. P15.041

180

Rebanadas por hora /
Slices per hour /
Tranches heure /
Scheiben pro Stunde



**WCT708E Tostadora de servicio mediano de 4 rebanadas / 4 - Slice Medium - Duty Toaster /
Grille - pain à usage moyen / 4 Scheiben Mittelleistungs Toaster**



225

Rebanadas por hora /
Slices per hour /
Tranches heure /
Scheiben pro Stunde

REF	RANURAS / SLOTS / FENTES / SCHLITZE	V	W	A	Hz	
WCT708E	4	230	1800	7,8	50/60	1



3,5 x 13,5 x 13,5 cm
Ranura / Slot / Fente / Schlitz

Con expulsión automática /
With pop up system /
Avec éjection automatique /
Automatischer Auswurf



MAQUINARIA /
EQUIPMENT /
EQUIPMENT

Planchas de fundición.
*Ranuras arriba y abajo.
Bandeja y recoge jugos.
Borde antisalpicaduras.
Luces piloto.
Termostato ajustable hasta 300 °C.

Cast iron griddle plates.
*Both plates with parallel grooves.
Large drip tray.
High turned-up spatter rim.
Indicator lights.
Adjustable thermostat to 300 °C.

Plaque en fonte.
*Rainures en bas et en haut.
Tiroir de propreté.
Bourdure anti projections haute.
Voyants lumineux.
Thermostat réglable jusqu'à 300 °C.

Grillplatten aus Gusseisen.
*Rillen oben und unten.
Fettauffangschale.
Seiten mit Antispritzschutz.
Kontrollleuchten.
Einstellbares Thermostat bis 300 °C.



Ref. P818.000
Incluido en el precio / Included on the price /
Inclus dans le prix / Inklusiv im Preis

VER PRODUCTOS EN / SEE PRODUCTS ON /
VOIR PRODUITS EN PAGE / SIEHE PRODUKTE IN

MOLDE HUEVO SANDWICH CUADRADO /
SQUARED EGG MOULD /
MOULE À OEUF CARRÉ /
RECHTECKIGE SPIEGELEIERFORM



P. 119

P15004 Grill de contacto "SOLO COMPACT" /
"SOLO COMPACT" Contact grill /
Grill de contact "SOLO COMPACT" /
"SOLO COMPACT" Kontaktgrill

INOX - ST/STEEL
EDELSTAHL
18/10



REF	Superficie de cocción / Cooking surface / Surface de cuisson / Grillplattenfläche cm	V	W	Hz	
P15.004*	22 x 23	230	1800	50/60	1

P15005 Grill de contacto "SOLO GRANDE" /
"SOLO GRANDE" Contact grill /
P15006 Grill de contact "SOLO GRANDE" /
"SOLO GRANDE" Kontaktgrill

INOX - ST/STEEL
EDELSTAHL
18/10



REF	Superficie de cocción / Cooking surface / Surface de cuisson / Grillplattenfläche cm	V	W	Hz	
P15.005*	32 x 21	230	2200	50/60	1
P15.006	32 x 21	230	2200	50/60	1

P15007 Grill de contacto "DUETTO COMPACT" /
"DUETTO COMPACT" Contact grill /
P15008 Grill de contact "DUETTO COMPACT" /
"DUETTO COMPACT" Kontaktgrill

INOX - ST/STEEL
EDELSTAHL
18/10



REF	Superficie de cocción / Cooking surface / Surface de cuisson / Grillplattenfläche cm	V	W	Hz	
P15.007*	47 x 23	230	3600	50/60	1
P15.008	47 x 23	230	3600	50/60	1

P15009 Grill de contacto "DUETTO GRANDE" /
"DUETTO GRANDE" Contact grill /
Grill de contact "DUETTO GRANDE" /
"DUETTO GRANDE" Kontaktgrill



REF	Superficie de cocción / Cooking surface / Surface de cuisson / Grillplattenfläche cm	V	W	Hz	
P15.009*	2 x (32 x 21)	2x230	2x2200	50/60	1



MAQUINARIA /
EQUIPMENT /
EQUIPMENT

BATIDORAS PLANETARIAS / MIXERS / MÉLANGEURS / MIXERS

Engranajes y ejes de acero de fundición permiten
alargar la vida del producto y proporcionan un
funcionamiento más silencioso/
Gears and shafts are made of heat-treated alloy
steel for long life and quieter operation/
Engrenages et arbres en acier allié traité
à la chaleur pour une longue durée et un
fonctionnement plus silencieux/
Zahnräder und Wellen aus wärmebehandeltem
legiertem Stahl gewährleisten eine lange
Lebensdauer und einen leiseren Betrieb

Acción de batido elíptico /
Planetary mixing action
Mélangeur planétaire /
Planetenrad-Misch-getriebe /

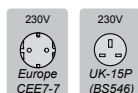

Incluye / Comes with / Livré avec / Standardausstattung:



Batidor varilla /
Wire Wishk /
Fouet à fil /
Schlagbesen



Gancho para masa /
Dough hook /
Crochet de pâte /
Knethaken



Espátula /
Spatula /
Spatule /
Schaber



Bol acero inoxidable /
S/Steel mixing bowl /
Bol mélangeur en acier inoxydable /
Edelstahl-Mischschüssel



Paro automático por sobre calentamiento /
Thermal overload protection automatically
shuts off mixer to protect from damage
Arrêt automatique par la surchauffe /
Wärmeüberlastschutz schaltet den Mixer
zur Schadens-verhütung automatisch aus

Temporizador digital 30 minutos, con paro
automático con señal acústica /
30 minute digital timer with automatic stop
and audible shutoff signal /
Minuterie numérique (30 minutes) à arrêt
automatique et signal d'arrêt sonore /
30-Minuten-Digitalzeituhr mit automatis-
chem Stopp und akustischem Abschaltsignal

Velocidades de mezcla constantes
independientemente del volumen /
Consistent mixing speeds regardless
of volume/
Vitesses de mélange uniformes, quel
que soit le volume /
Gleichmäßige, von der Menge un-
abhängige Mischgeschwindigkeiten

Protección Seguridad /
Safety guard /
Protecteur de sécurité /
Schutzblende

Construcción extra robusta /
Heavy-duty construction /
Construction robuste /
Stark belastbare Ausführung

4075502 Amasadora sobre mesa / Countertop Mixers / Mélangeurs de comptoir / Arbeitsflächen-Mixer



1/3 HP / 250 W / 3 A

REF	Lts.	cm (W X D X H)	VELOCIDAD / SPEED / VITESSE / GESCHWINDIGKEIT	V	ENCHUFE / PLUG / PRISE / STECKER	
4075502	6,6	33,5 x 45 x 51,5	5	220-230	Europe	1
4075503	6,6	33,5 x 45 x 51,5	5	220-230	UK	1
4075602	9,5	33,5 x 45 x 54	5	220-230	Europe	1
4075603	9,5	33,5 x 45 x 54	5	220-230	UK	1



4075503

REF	PARA / FOR / POUR / FÜR (LTS)	
	Batidor varilla / Wire Wishk / Fouet à fil / Schlagbesen	
XMIX0705	6.6	1
40762	9.5	1
	Gancho para masa / Dough hook / Crochet de pâte / Knethaken	
XMIX0704	6.6	1
40763	9.5	1

REF	PARA / FOR / POUR / FÜR (LTS)	
	Espátula / Spatula / Spatule / Schaber	
XMIX0703	6.6	1
40764	9.5	1
	Bol acer / Mixing bowl / Bol mélangeur / Mischschüssel	
XMIX0702	6.6	1
40761	9.5	1

Panel de control digital para simplificar el
cambio de velocidades mientras la unidad
está funcionando

Digital control panel to make easy speed
shifts while unit is running.

Panneau de commande numérique pour
faciliter les changements de vitesse pendant
le fonctionnement de l'appareil

Digitalbedienfeld ermöglicht einfache
Drehzahländerungen bei laufendem Gerät

**4075702 Amasadora de pié / Floor-Bench mixers /
Mélangeurs au sol-sur plan de travail / Boden-Tisch-Mixer**



4075702

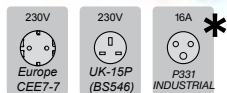

REF	Lts.	cm (W X D X H)	VELOCIDAD / SPEED / VITESSE / GESCHWINDIGKEIT	V	HP	W	A	ENCHUFE / PLUG / PRISE / STECKER	
4075702	19	52 x 52 x 91	3	220-230	0,5	370	4	Europe	1
4075703	19	52 x 52 x 91	3	220-230	0,5	370	4	UK	1
4075802	28	64 x 62 x 122	3	220-230	1,0	750	8	Europe	1
4075803	28	64 x 62 x 122	3	220-230	1,0	750	8	UK	1
4075902	38	68 x 68 x 120	3	220-230	1,5	1120	11	Europe	1
4075903	38	68 x 68 x 120	3	220-230	1,5	1120	11	UK	1
4076002	57	70 x 76 x 142	3	220-230	2,0	1500	16	Europe	1
4076003*	57	70 x 76 x 142	3	220-230	2,0	1500	16	UK	1

REF	PARA / FOR / POUR / FÜR (LTS)	
Batidor varilla / Wire Wishk / Fouet à fil / Schlagbesen		
40766	19	1
40770	28	1
40774	38	1
40778	57	1
Gancho para masa / Dough hook / Crochet de pâte / Knehtaken		
40767	19	1
40771	28	1
40775	38	1
40779	57	1

REF	PARA / FOR / POUR / FÜR (LTS)	
Espátula / Spatula / Spatule / Schaber		
40768	19	1
40772	28	1
40776	38	1
40780	57	1
Bol acer / Mixing bowl / Bol mélangeur / Mischschüssel		
40765	19	1
40769	28	1
40773	38	1
40777	57	1

**P15089 / P15090 / P15091 Cortadora eléctrica de fiambres / Electric slicing machine /
Trancher électrique / Elektrische Aufschnittmaschine**



Cuerpo: aluminio pintado.
Body: painted aluminium.
Corps: aluminium peint.
Körper : Aluminiumbeschichtet.

REF	V	Hz	W	Ø CUCHILLA BLADE LAME MESSER cm	ESPELOR CORTE SLICER THICKNESS ÉPAISSEUR DE COUPE SCHNITTBREITE mm	Dim cm	Kg	
P15.089	230	50	120	22	0-9	48 x 40 x 37	14,8	1
P15.090	230	50	150	25	0-9	48 x 40 x 37	16,0	1
P15.091	230	50	250	30	0-11	59 x 38 x 43	22,6	1

Ref. P15.090

Ø 25 cm
Cuchilla / Blade /
Lame / Messer



Ref. P15.091

Ø 30 cm
Cuchilla / Blade /
Lame / Messer



Ref. P15.089

Ø 22 cm
Cuchilla / Blade /
Lame / Messer



VER PRODUCTOS EN / SEE PRODUCTS ON /
VOIR PRODUITS EN PAGE / SIEHE PRODUKTE IN

GEL LUBRICANTE SANITARIO /
SANITARY GEL LUBRICANT /
GEL LUBRIFIANT SANITAIRE /
MEDIZINISCHES GLEITGEL



P. 136



Lleve a cabo cualquier tarea de mezclado/licuado con los brazos trituradores portátiles Waring Commercial. Desde el versátil modelo QuickStik hasta el modelo de servicio pesado de 1 HP Big Stix, estos brazos trituradores son herramientas básicas para las cocinas más atareadas de hoy. Con varillas de 17.75 a 53.5 cm, permiten procesar desde 11.5 hasta 200 litros a la vez. Las cuchillas multifunción de acero inoxidable garantizan un licuado homogéneo, y el cómodo mango ofrece mayor control. ¡Licue, bata, mezcle y haga purés sin esfuerzo gracias a Waring!

Power through any mixture with the portable handheld Waring Commercial Immersion Blenders. From the versatile QuikStik to the heavy-duty 1 HP Big Stix, these are essential tools for today's busy kitchens. The shaft sizes range from 17.75 cm to 53.5 cm with capacities from 11.5 to 200 liters. The all-purpose stainless steel blades ensure smooth, consistent blending, and the comfort grips keep the user in control. Blend, whisk, mix, purée and whip with Waring!

Mixez en toute facilité grâce aux mixeurs Waring Commercial. Du plus pratique (le QuikStik) au plus puissant (le Big Stix de 1 HP), ce sont des outils essentiels pour les cuisines modernes. Leurs pieds de 17,75 à 53,5 cm permettent de mixer 11,5 à 200 L à la fois. Leurs lames en acier inoxydable garantissent des résultats homogènes. Leurs poignées ergonomiques offrent un maximum de confort. Mixez, fouettez, mélangez et réduisez en purée sans effort grâce à Waring !

Leistungsstarkes Mixen und Verflüssigen mit den Stabmixern Waring Commercial. Von dem vielseitigen Modell QuickStik bis hin zum robusten 1 HP Big Stick sind diese Stabmixer heutzutage ein wesentliches Werkzeug der vielbeschäftigten modernen Küchen. Mit Stablängen von 17,75 bis 53,5 cm kann man von 11,5 bis 200 Liter auf einmal bearbeiten. Die Multifunktionsmesser aus rostfreiem Stahl garantieren ein homogenes Zerkleinern und die bequemen Griffe bieten eine gute Kontrolle. Verflüssigen, Mixen und Pürieren Sie mühelos mit Waring!



**Brazo triturador de servicio pesado Big Stix /
Heavy-Duty Big Stix /
Bras mixeur à usage intensif Big Stix /
Einarmiger Hochleistungsstabmixer Big Stix**

Bloque motor universal adaptable a todos los brazos y batidores. Motor de servicio pesado de 1 HP (potencia de entrada máxima). Velocidad variable. 18 000 RPM a velocidad alta (1600 RPM con los batidores). Función de encendido continuo. Acoplamientos (bloque-motor y varilla) reemplazables por el usuario. Cómodo mango cubierto de caucho y empuñadura auxiliar, para mayor control y seguridad. Varilla de acero inoxidable sellada, removible y apta para lavavajillas.

Universal power pack fits all shafts and whisk attachments. 1 peak input HP heavy-duty motor. Variable speed operation. 18,000 RPM on high (1,600 for whipping paddles). Continuous ON feature. User-replaceable couplings on power pack and shaft. Rubberized comfort grip and second handle for safe and controlled operation. Completely sealed stainless steel shaft is easily removable and dishwasher safe.

Bloc-moteur universel adaptable à tous les pieds et fouets. Moteur haute performance de 1 HP (puissance d'entrée maximale). Vitesse variable. 18.000 tr/mn à haute vitesse (1 600 tr/mn avec les fouets). Marche continue. Accouplements (bloc-moteur et pied) faciles à changer. Poignée caoutchoutée et poignée auxiliaire, pour davantage de confort et de sécurité. Pied hermétique en acier inoxydable, amovible et compatible lave-vaisselle.

Universeller Motorblock geeignet für alle Stablängen und Halter. Hochleistungsmotor von 1 HP (max. Eingangsleistung). Variable Geschwindigkeit. Max. 18.000 U/min (1.600 U/min. Rührbesen). Funktion Dauerbetrieb. Durch Kopplung (Motorblock - Stab) vom Benutzer austauschbar. Bequemer Griff mit Kautschukbeschichtung und Hilfsgriff bieten eine höhere Kontrolle und Sicherheit. Stab aus versiegeltem rostfreiem Stahl, austauschbar und Spülmaschinen geeignet.



WSBPPCE Bloque motor / Power Pack
Bloc-moteur / Motorblock

REF	W	Hz	
WSBPPCE	1 HP / 750 W	50/60	1

WSB50ST WSB55ST WSB60ST WSB65ST WSB70ST



Varilla / Shaft / Pied / Stab

REF	Varilla extraíble / Removable Shaft / Pied amovible / Abnehmbarer Stab	Capacidad / Capacity / Capacité / Kapazität	
WSB50ST	30,5 cm	40 L	1
WSB55ST	35,5 cm	60 L	1
WSB60ST	40,5 cm	100 L	1
WSB65ST	45,5 cm	140 L	1
WSB70ST	53,5 cm	200 L	1





INOX - ST/STEEL
EDELSTAHL

WSB2W

**Accesorio batidor / Whisk Attachment /
Fouets / Rührbesen Zubehör**

REF	L cm	
WSB2W	25,5	1

Caja de engranaje de fundición, para mejor desempeño.

Engrenage en acier moulé, pour des performances optimales.

Die-cast gears for optimal performance.

Gegossenes Getriebegehäuse für eine bessere Performenz.

LOW: 17.000 RPM
HIGH: 18.000 RPM



WSB40E

**Brazo triturador de servicio mediano /
Quik Stik Plus / Medium-Duty Quik Stik Plus /
Bras mixeur Quick Stik Plus à usage moyen /
Stabmixer mittlerer Gebrauch Quik Stik Plus**

REF	Hz	
WSB40E	50/60	1

Motor de servicio pesado de ½ HP, con 2 velocidades/370 W.
Varilla fija de 25.5 cm.
Capacidad de 23 litros .
230V, 50 Hz, 1.5 A.
Homologado CE y RoHS.

Puissant moteur de ½ HP, à deux vitesses/370 W.
Pied fixe de 25,5 cm.
Capacité de 23 litres.
230V, 50 Hz, 1,5A.
Homologué CE et RoHS.

½ HP, 2-speed.
heavy-duty motor/370 W.
25.5 cm fixed shaft.
23-liter capacity.
230 volts, 50 Hz, 1.5.
amps. CE, RoHS.

Ochleistungsmotor von ½ HP, mit 2 Geschwindigkeiten /370 W. Fester Stab von 25.5 cm. Bearbeitungsvermögen 23 Liter. 230 V, 50 Hz, 1,5 A, Zertifiziert mit CE und RoHS.



LOW: 14.500 RPM
HIGH: 15.000 RPM



WSB33XE

**Brazo triturador de servicio ligero Quik Stik /
Light-Duty Quik Stik /
Bras mixeur Quick Stik à usage léger /
Stabmixer leichter Gebrauch Quik Stik**

REF	Hz	
WSB33XE	50/60	1

Motor de alta eficacia, con dos velocidades.
Varilla fija de 17.75 cm.
Capacidad de 11.5 litros.
230V, 50 Hz, 0.4 A, 175 W.
Homologado CE y RoHS.

Moteur hautement efficace à deux vitesses.
Pied fixe de 17,75 cm.
Capacité de 11,5 litres.
230V, 50 Hz, 0,4A, 175 W.
Homologué CE et RoHS.

2-speed high-efficiency motor.
17.75 cm fixed shaft.
11.5-liter capacity.
230 volts, 50 Hz, 0.4 amps,
175 W. CE, RoHS.

Motor mit hoher Leistung und zwei Geschwindigkeiten und festem Stab von 17.75 cm Länge. Bearbeitungsvermögen 11.5 Liter. 230 V, 50 Hz, 0.4 A, 175 W. Zertifiziert mit CE und RoHS





UNA BATIDORA DE VASO PARA CADA NECESIDAD /
A BLENDER FOR EVERY NEED /
UN BLENDER POUR TOUS LES BESOINS /
EIN STANDMIXER FÜR JEDES BEDÜRFNIS



BLADE

TORQ
2.0

PREP XTREME

Batidora de vaso para cócteles
Bar Blender
Blender de bar
Barcocktailstandmixer

Batidoras de vaso profesionales
NuBlend Commercial Blenders
Blenders professionnels NuBlend
NuBlend professioneller
Standmixer

Torq Series

Batidoras de vaso de servicio pesado
Heavy Duty Blenders
Blenders haute puissance
Hochleistungsstandmixer

Batidoras de vaso de 4 L
4-Liter Food Blenders
Blenders de 4 L
4 Liter Standmixer

BEBIDAS POR DÍA / DRINKS PER DAY / BOISSONS - JOUR / GETRÄNKE PRO TAG

1 – 25

25 – 49

50 – 74

75 +

100 +

USO Y SERVICIO / USAGE AND APPLICATION TYPE / UTILISATION / GEBRAUCH UND EINSATZMÖGLICHKEIT

Preparación de bebidas Servicio ligero a mediano	Preparación de alimentos y bebidas Servicio ligero a mediano	Preparación de alimentos y bebidas Servicio mediano a pesado	Preparación de bebidas y alimentos Servicio pesado	Preparación de alimentos Servicio pesado
Light to Medium Beverage Prep	Light to Medium Food and Beverage Prep	Medium to Heavy Food and Beverage Prep	Heavy Food and Beverage Prep	Heavy Food Prep
Préparation de boissons Usage léger à moyen	Préparation de boissons et culinaire, usage léger et moyen	Préparation de boissons et préparation culinaire Usage moyen à intensif	Préparation de boissons et préparation culinaire Usage intensif	Préparation culinaire Usage intensif
Zubereitung von Getränken Gering- oder Mittelgebrauch	Zubereitung von Lebensmittel und Getränken Gering- oder Mittelgebrauch	Zubereitung von Lebensmittel und Getränken Mittel- und Vielgebrauch	Zubereitung von Lebensmittel und Getränken Vielgebrauch	Zubereitung von Lebensmittel Vielgebrauch

IDEAL PARA / GREAT FOR USE IN / TYPES DE COMMERCE / IDEAL FÜR

Bares	Bares, restaurantes pequeños y heladerías	Bares, restaurantes y heladerías	Heladerías, cafeterías, restaurantes, bares, establecimientos de cuidado de la salud, escuelas, instituciones	Restaurantes grandes, establecimientos de cuidado de la salud, escuelas, instituciones
Bars	Bars, Small Restaurants, Smoothie Shops	Bars, Restaurants, Smoothie Shops	Smoothie Shops, Coffee Shops, Restaurants, Bars, Healthcare, Schools, Institutions	Large Restaurants, Healthcare, Schools, Institutions
Bars	Bars, petits restaurants, commerces de jus de fruits frais	Bars, restaurants, commerces de jus de fruits frais	Bars/Commerces de jus de fruit, salons de thé, restaurants, centres de remise en forme, établissements scolaires ou médicaux, institutions	Restaurants, brasseries, établissements scolaires ou médicaux, institutions
Bars	Bars, kleine Restaurants und Eisdielen	Bars, Restaurants und Eisdielen	Eisdielen, Bsitros, Restaurants, Bars, Wellnessrichtungen, Schulen, Institute	Grosse Restaurants, Wellnesseinrichtungen, Schulen, Institute

APLICACIONES RECOMENDADAS / RECOMMENDED APPLICATIONS / IDÉAL POUR LA PRÉPARATION DE / IDEAL FÜR DIE ZUBEREITUNG VON

Bebidas heladas, batidos de fruta, margaritas y mucho más	Cócteles helados, batidos de helado, salsas frías y calientes, aderezos y más	Margaritas, daiquiris, granitas, salsas, sopas y más	Batidos de fruta, bebidas de café helado, cócteles helados, salsas, aderezos, sopas, postres, aliños y mucho más	Aliños, salsas, aderezos, sopas y más
Frozen Drinks, Smoothies, Margaritas and More	Frozen Cocktails, Ice Cream Drinks, Dips, Salsas, Sauces and More	Margaritas, Daiquiris, Granitas, Sauces, Soups and more	Fruit Smoothies, Iced Coffee Drinks, Frozen Cocktails, Salsas, Sauces, Soups, Desserts, Dressings and more	Dressings, Salsas, Sauces, Soups and More
Milkshakes, boissons glacées, cocktails, Margaritas, etc.	Boissons glacées, milkshakes, cocktails, sauces, etc.	Margaritas, Daiquiris, Granitas, sauces, soupes, etc.	Smoothies, café glacé, cocktails glacés, sauce, crèmes, soupes, desserts, vinaigrettes, etc.	Vinaigrettes, sauces, crèmes, soupes, etc.
Gefrorene Getränke, Fruchtcocktails, Magaritas und vieles mehr	Eiscocktails, Eishakes, kalte und heisse Sossen, Dressings und vieles mehr	Margaritas, Daiquiris, Granitas, Sossen, Suppen und vieles mehr	Fruchtcocktails, gefrorene Kaffeegetränke, Eiscocktails, Sossen, Nachtisch, Dressings und vieles mehr	Dressing, Sossen, Suppen und vieles mehr

MAQUINARIA /
EQUIPMENT /
EQUIPMENT



Las batidoras de vaso profesionales Waring Commercial son herramientas esenciales para cualquier bar o restaurante. Esta línea clásica siempre logra resultados profesionales, gracias a características profesionales: resistentes jarras de alta capacidad de acero inoxidable, copoliéster sin bisfenol-A o cristal; potentes motores de hasta 1120W y cuchillas de acero inoxidable que siempre logran resultados rápidos y homogéneos. ¡Pique hielo y prepare bebidas en tan sólo segundos con las potentes licuadoras profesionales Waring Commercial!

The staple in any bar or restaurant, the Waring Commercial Blender consistently delivers a professional blend. This classic product line offers a variety of sizes, styles and capacities in durable stainless, BPA-free copolyester, or glass containers. Powerful, professional motors with up to 1120W HP drive stainless steel cutting blades for quick, consistent results. Crush ice in seconds and make drinks instantly with the power of Waring Commercial!

Les blenders Waring Commercial sont les outils de base par excellence pour tout type de bar ou restaurant. Disponibles en plusieurs tailles et styles (acier inoxydable, copolyester sans BPA, verre), ces outils classiques sont équipés de puissants moteurs professionnels jusqu'à 1120W et de couteaux en acier inoxydable, pour des résultats rapides et homogènes. Broyez de la glace et préparez des boissons en quelques secondes grâce aux puissants bols mixeurs Waring Commercial!

Die professionellen Standmixer von Waring Commercial sind essentielle Werkzeuge für jede Bar oder Restaurant. Die klassische Produktlinie bietet immer professionelle Ergebnisse, dank seiner professionellen Eigenschaften:

Resistente Behälter von grossem Fassungsvermögen aus rostfreiem Stahl, Glas oder Copolyester ohne Bisfenol-A (BPA); leistungsstarken Motoren von bis zu 1120W und messer aus rostfreiem Stahl, die immer für ein schnelles und homogenes Ergebnis sorgen. Zerkleinern Sie Eis und bereiten Sie Getränke in Sekundenschnelle mit den leistungsstarken Mixern von Waring Commercial!

BB340E Batidora de vaso comercial Blade Series / Blade Series Commercial Blender /
Mixeur à jarre commerciale Blade Series / Gewerblicher Standmixer Blade Series

BLADE



21.700 RPM - 3,6 A



25-49

Bebidas por día /
Drinks per day /
Boissons - jour /
Getränke pro tag



REF	V	W	Hz	
BB340E	220-240	1 HP / 750 W	50/60	1

Jarra copoliéster.
Controles electrónicos: Alto, Bajo,
Apagado y Pulso.
Con temporizador de cuenta
regresiva de 99 segundos.

Copolyester.
Contrôle électronique: Haut, Bas,
Arrêt et Pulse.
Avec minuteur de 99 secondes
regressive de 99 secondes.

Copolyester container.
High, Low, Off and Pulse electronic
controls.
With 99-second countdown timer.

Copolyester.
Elektronische Kontrolle: High,
Low, Off und Puls.
Mit 99 Sekunden Countdown
Timer.

BB300E Batidora de vaso comercial Blade Series / Blade Series Commercial Blender /
Mixeur à jarre commerciale Blade Series / Gewerblicher Standmixer Blade Series

BLADE



21.700 RPM - 3,6 A



25-49

Bebidas por día /
Drinks per day /
Boissons - jour /
Getränke pro tag



REF	V	W	Hz	
BB300E	220-240	1 HP / 750 W	50/60	1

Jarra copoliéster.
Controles mecánicos: Alto, Bajo,
Apagado y Pulso.

Bol en copolyester.
Interrupteurs à bascule: Haut, Bas,
Arrêt et Pulse.

Copolyester container.
High, Low, Off and Pulse toggle
switches.

Behälter aus copolyester.
Mechanische Kontrolle: High, Low,
Off und Puls.

CAC132

Jarra / Container /
Bol / Karaffen

REF	Lts	
CAC132	1,40	1

Apilable / Stackable / Empilable / Stapelbar



BB255E Batidoras de vaso para cócteles básicas / Basic Bar Blenders / Blenders de bar / Basis Cocktail Mixer



21.000 RPM - 2,2 A



1-25

Bebidas por día /
Drinks per day /
Boissons - jour /
Getränke pro tag



REF	Lts	V	W	Hz	
BB255E	1,30	220-240	3/4 HP / 550 W	50/60	1

2 velocidades. Resistente cuchilla
de acero inoxidable de dos piezas.
Acoplamiento de goma reforzado
con metal y reemplazable por el
usuario.
BB255E: Jarra copoliéster.

2 vitesses. Couteau 2 pièces
robuste et en acier inoxydable.
BB255E: Bol en copolyester.

2 speeds. Rugged, two-piece
stainless steel cutting blade.
User-replaceable, metal-
reinforced rubber drive coupling.
BB255E: Copolyester container.

2 geschwindigkeiten. Zweiteilige
robuste Edelstahl Klingen
BB255E: Behälter aus copolyester.



**TODO LO QUE NECESITAS
SABER PARA EQUIPAR
TU COCINA/**



EVERYTHING YOU NEED
TO KNOW TO EQUIP
YOUR KITCHEN/

TOUT CE QUE VOUS AVEZ
BESOIN DE SAVOIR POUR
ÉQUIPER VOTRE CUISINE/

ALLES WAS SIE WISSEN
MÜSSEN, UM IHRE KÜCHE
ZU AUSSTATTEN

TORQ 2.0



Tapa para alimentos/
líquidos calientes de vinilo
con tapón extraíble.

Vinyl lid for hot food/
beverage blending and
removable center cap
that locks into place or
can be removed to feed
ingredients while blending.

Couvercle en vinyle pour
aliments/liquides chauds
avec bouchon doseur
amovible.

Deckel für heiße
Lebensmittel/
Flüssigkeiten aus Vinyl
mit abnehmbaren
Verschlusskopf.

Jarra apilable transparente
de 1.4 L resistente, de
servicio pesado y de calidad
profesional. Diseño
único, para máxima eficacia y
rendimiento.

1.4L clear-view stackable jar
– commercial
grade, heavy-duty and
breakresistant.
Uniquely shaped for maximum
efficiency and performance.

Bol transparent empilable de
1,4 L résistant,
à usage intensif et de qualité
professionnelle.
Spécialement conçu pour
maximiser l'efficacité et le
rendement.

1,4 l stapelbarer transparenter
Behälter, resistent gegen
häufigen Gebrauch und mit
professioneller Qualität.
Einzigartiges Design für
höchste Effizienz und Leistung.

Resistente cuchilla de acero
inoxidable con robustas piezas
de acero, hechas para durar
pero reemplazables por el
usuario. Su forma "agresiva"
ha sido especialmente
diseñada para este vaso y
es capaz de picar hielo al
instante.

Heavy-duty stainless steel
blade with solid steel blending
assembly – built to last but
completely user-replaceable.
This aggressive blade design is
configured specifically for this
jar and is engineered to crush
ice instantly.

Couteau en acier inoxydable
avec pièces en acier massif
construits pour durer mais
remplaçables par l'utilisateur.
Couteau "agressif"
spécialement conçu pour le bol
et capable de broyer la glace
instantanément.

Resistente Messer aus
rostfreiem Stahl mit robusten
Stahlteilen, gemacht für
Langlebigkeit aber auch durch
den Benutzer austauschbar.
Die "aggressive" Form ist
speziell für den Behälter
disignt und ist in der Lage Eis
sehr schnell zu crashen.

Controles HI/LO/STOP/
PULSE con temporizador
de cuenta progresiva de
60 segundos (modelos
sin temporizador también
disponibles) – Las
batidoras de vaso Margarita
Madness® Elite vienen
equipadas con tres tipos de
controles: mecánicos,
electrónicos y electrónicos
con temporizador.

HI/LO/STOP/PULSE controls
with 60-second countdown
timer (non-timer versions
available) – the Margarita
Madness Elite Series
Blenders feature three
control styles – a simple
toggle switch control,
electronic keypad and
electronic keypad with
60-second countdown timer.

Commandes HAUT/BAS/
ARRÊT et PULSE avec
minuteur de 60 secondes
(modèles sans minuteur
également disponibles). Les
bols mixeurs de la série
Margarita Madness Elite sont
disponibles en trois styles :
commandes mécaniques,
commandes électroniques
ou commandes
électroniques avec minuteur
de 60 secondes.

HI/LO/STOP/PULSE
Kontrolle
mit 60 Sekunden Countdown.
(Modelle ohne Timerfunktion
auch erhältlich) - Die Mixer
Margarita Madness® Elite
sind ausgestattet mit 3
verschiedenen Kontrollen:
Meschanisch, Elektronisch
oder Elektronisch mit
Timerfunktion.

Base resistente y compacta
con potente motor de 2
HP/1490 vatios y cojinete
amortiguador removible para
facilitar la limpieza.

Heavy-duty base with
powerful 2 HP, 1490W motor
– this amazing combination
makes for big power yet
small foot print and includes
a removable jar pad for easy
cleanup.

Boitier résistant et compact
avec puissant moteur
de 2 HP/1490W et coussin
amortisseur amovible
pour faciliter le nettoyage.

Resistente und kompakte
Basis mit einem
leistungsstarkem
Motor von 2 HP, 1490W
und mit abnehmbarer
Stossdämpfungseinheit zur
einfachen Reinigung

TORQ 2.0

2 HP / 1490 W
24.500 - 27.000 RPM - 6,1 A

1,4 Lts
Jarra.
Container.
Bol.
Karaffen.



Capaz de preparar 3 margaritas de 470 ml en 8 segundos o menos.
Blend three 470 ml margaritas in 8 seconds or less.
Permet de préparer 3 margaritas de 470 ml en 8 secondes ou moins.
Fähig 3 margaritas von 470 ml in 8 oder weniger Sekunden herzustellen

50-74
Bebidas por día /
Drinks per day /
Boissons - jour /
Getränke pro tag



TBB145E

**Batidora de vaso Torq / Torq blender /
Blender Torq / Mixer der Torq**

REF	Lts	V	W	Hz	
TBB145E	1,40	220-240	2 HP / 1400 W	50/60	1

Controles mecánicos clásicos.
Classic toggle switch.
Interrupteur à bascule.
Klassischer.



TBB160E

**Batidora de vaso Torq / Torq blender /
Blender Torq / Mixer der Torq**

REF	Lts	V	W	Hz	
TBB160E	1,40	220-240	2 HP / 1400 W	50/60	1

Controles electrónicos con temporizador de cuenta regresiva de 60 segundos.
Electronic keypad with 60-second countdown timer.
Contrôle électronique avec minuteur de 60 secondes.
Elektronische Kontrolle mit 60 Sekunden Countdown Timer.





Con potencia máxima de hasta 3½ HP/2600W, las batidoras de vaso de alta potencia de la serie Xtreme de Waring Commercial dan una potente ventaja a cualquier negocio. Logran impecables resultados y ofrecen mayor versatilidad, gracias a características únicas como temporizador integrado y velocidad variable hasta 30 000+ RPM. Con duraderas jarras de acero inoxidable o copoliéster sin bisfenol A (BPA) y controles electrónicos o mecánicos fáciles de usar, son perfectas para todas sus tareas de preparación de bebidas y alimentos.

Waring Commercial heavy-duty 3½ peak HP/2600W Blenders give every commercial environment a high-powered advantage. With 30,000+ RPM and models with built-in timers and variable speeds, these high-performance blenders produce flawless results every time. The durable BPA-free copolyester or stainless steel containers with simple touchpads or toggles are perfect for anything from food prep to smoothies!

Les blenders de la gamme Xtreme, équipés de moteurs de 3½ HP/2600W, sont un atout de taille pour les professionnels de la restauration. Dotés de caractéristiques uniques (moteurs à vitesse variable de 30.000+ tr/mn, minuteur sur certains modèles), ces puissants appareils permettent de toujours obtenir des résultats optimaux. Équipés de bols en copolyester sans PBA ou en acier inoxydable et de contrôles électroniques ou interrupteurs à bascule, ils sont parfaits pour toutes les tâches de préparation d'aliments et de boissons.

Mit der Höchstleistung von bis zu 3½ HP/2600W, geben die Xtreme Hochleistungsstandmischer von Waring Commercial jedem Geschäft einen aussagekräftigen Vorteil. Sie bieten unschlagbare Ergebnisse und eine hohe Vielseitigkeit, dank seiner einzigartigen Eigenschaften mit einem integrierten Timer und einer regulierbaren Geschwindigkeit von bis zu 300.000+ U/min. Mit langlebigen Behältern aus Edelstahl oder Copolyester ohne Bisphenol A (BPA) und einer elektronischen oder mechanischen Kontrolle für die einfache Handhabung, eignen sie sich perfekt für alle Aufgaben der Getränke und Lebensmittelzubereitung.

ROBUSTO MOTOR DE 3½ HP/2600W
VELOCIDAD SUPERIOR A 30 000 RPM COJINETE
AMORTIGUADOR DE UNA PIEZA,
EXTRAIBLE Y APTO PARA LAVAVAJILLAS

HEAVY-DUTY 3.5 PEAK/2600W HP MOTOR
BLADE SPEED OF OVER 30,000 RPM
ONE-PIECE DISHWASHER-SAFE
REMOVABLE JAR PAD

MOTEUR HAUTE PERFORMANCE DE 3½
HP/2600W VITESSE SUPÉRIEURE À 30 000 TR/
MN COUSSIN AMORTISSEUR D'UNE PIÈCE,
AMOVIBLE ET COMPATIBLE LAVE-VAISSELLE

ROBUSTER MOTOR 3½ HP/2600W
HÖCHSTGESCHWINDIGKEIT ÜBER 30 000 U/MIN
STOSSDÄMPEREINHEIT AUS EINEM STÜCK
AUSSTAUSSCHBAR UND SPÜLMASCHINEN
GEEIGNET



Cojinete amortiguado de una sola pieza extraíble y apto para lavavajillas.
One-piece dishwasher-safe removable jar pad.
Coussin amortisseur d'une pièce, amovible et compatible lave-vaisselle.
Stossdämpfereinheit aus einem Stück.



45.000 RPM

+75

Bebidas por día /
Drinks per day /
Boissons - jour /
Getränke pro tag



MX1500XTXSEE

REF	Lts	W	
MX1500XTXSEE	2,00	3,5 HP / 2600 W	1

4 botones programables para preparar bebidas
Pantalla LCD con retroiluminación azul, para mayor comodidad
Contador de bebidas con total y total diario
Velocidad variable
Función de pulso con control de velocidad programable
Con recinto de insonorización.

4 reprogrammable beverage stations
LCD display with blue backlight for easy viewing and program selection
Daily and total drink counter display
Adjustable speed controls
Dual PULSE feature with reprogrammable speed control.
With sound enclosure.

Quatre boutons programmables pour la préparation des boissons
Écran numérique avec rétro-éclairage
Compteur qui affiche le total de préparations du jour et le grand total
Vitesse variable
Double fonction PULSE avec vitesse programmable
Avec système d'insonorisation.

Station mit 4 programmierbaren Knöpfen zur Getränkezubereitung.
LCD Display mit blauer Beleuchtung, für die einfache Handhabung.
Gesamt- und Tageseinheitenzähler.
Variable Geschwindigkeit
PULSE Funktion mit programmierbarer Geschwindigkeit.
Gehäuse mit Geräuschisolierung.



20.000 RPM

+75

Bebidas por día /
Drinks per day /
Boissons - jour /
Getränke pro tag



MX1200XTXEE

**Batidora de vaso de alta potencia con velocidad variable /
Hi-Power Variable Speed Blender /
Blender haute puissance à vitesse variable /
Hochleistungsstandmixer mit variabler Geschwindigkeit**

REF	Lts	W	
MX1200XTXEE	2,00	3,5 HP / 2600 W	1

Cojinete amortiguador de una pieza, extraíble y apto para lavavajillas.
Jarras y recintos de insonorización disponibles.

One-piece dishwasher-safe removable jar pad. All units available with the following jars and sound enclosures.

Coussin amortisseur d'une pièce, amovible et compatible lave-vaisselle. Bols et systèmes d'insonorisation disponibles.

Stossdämpfereinheit aus einem Stück, austauschbar und spülmaschinengeeignet. Behälter und Gehäuse mit Geräuschisolierung erhältlich.



IDEA!

Ideal para amasar masa de pan, montar claras, licuar sopas y batidos y mucho más.
Ideal for whipped egg whites, soups, smoothies and everything in between.

Idéal pour pain aux blancs d'œufs en neige, soupes, milk-shakes et plus encore.

Ideal für durchzuführen, Durchkneten von Teigmassen, Eiweiss schlagen, Suppen verflüssigen, Mischen und vieles mehr.



45.000 RPM

+75

Bebidas por día / Drinks per day / Boissons - jour / Getränke pro tag



MX1100XTXSEE

REF	Lts	W	
MX1100XTXSEE	2,00	3,5 HP / 2600 W	1

Controles electrónicos fáciles de limpiar con funciones de ENCENDIDO/APAGADO, ALTO, BAJO, PAUSA y PULSO. Temporizador electrónico de cuenta regresiva de 30 segundos. Con recinto insonorización.

Contrôle électronique facile à nettoyer avec boutons MARCHE/ ARRÊT, HAUT, BAS, PAUSE et PULSE. Minuteur électronique de 30 secondes. Avec système d'insonorisation.

Easy-to-clean electronic membrane keypad with simple ON/OFF, HIGH, LOW, STOP and PULSE controls. 30-second electronic countdown timer. With sound enclosure.

Elektronische Kontrolle einfach zu reinigen mit Funktionen ON/OFF, HIGH, LOW, STOP und PULSE. Elektronischer Timer mit 30 Sekunden Countdown Funktion. Gehäuse mit Geräuschisolierung



30.000 RPM

+75

Bebidas por día / Drinks per day / Boissons - jour / Getränke pro tag



MX1000XTXEE / MX1000XTPEE

REF	Lts	W	
MX1000XTXEE	2,00	3,5 HP / 2600 W	1
MX1000XTPEE	1,40	3,5 HP / 2600 W	1

Sencillos controles mecánicos: ALTO/BAJO/APAGADO y PULSO.

Interrupteurs à bascule HAUT/BAS/ARRÊT et PULSE.

Simple HIGH, LOW, OFF and PULSE paddle switches.

Einfache mechanische Kontrolle: HIGH, LOW, OFF und PULSE.

ADAPTABLES A / ADJUSTABLES TO / ADAPTABLE À / PASSEND ZU:



VER PRODUCTOS EN / SEE PRODUCTS ON / VOIR PRODUITS EN PAGE / SIEHE PRODUKTE IN

V I O L E T
C O L L E C T I O N
 P. 104



CAC951 / CAC951-10



Jarra de copoliéster. Copolyester jar. Bol en copolyester. Behälter aus Copolyester.



CAC93XI / CAC93XI-10



Jarra de copoliéster. Copolyester jar. Bol en copolyester. Behälter aus Copolyester.



SE1000

Compatible con todas las batidoras de vaso Waring® Commercial Xtreme de 2 L

Commercial Xtreme. Retrofits all blenders in Waring® Commercial Xtreme Series - 2 L containers

Compatible avec tous les blenders de 2 L de la gamme Waring® Commercial Xtreme

Geeignet für alle 2 L. Standmixer Waring® Commercial Xtreme.



SE500

Compatible con todas las batidoras de vaso Waring® Commercial Xtreme de 1.4 L

Retrofits all blenders in Waring® Commercial Xtreme Series - 1,4 L containers

Compatible avec tous les blenders 1,4 L de la gamme Waring® Commercial Xtreme.

Geeignet für alle 1,4 l. Standmixer Waring® Commercial Xtreme.



REF	L	
CAC951	2	1
CAC951-10	2	1

REF	L	
CAC93XI	1,4	1
CAC93XI-10	1,4	1

REF	
SE1000	1

REF	
SE500	1



CB15VE Batidora de vaso 4 litros / 4-Liter food blender / Bol mixeur 4 litres / Standmixer mit 4 Liter Behälter

28000 RPM - 16 A



+100

Bebidas por día /
Drinks per day /
Boissons - jour /
Getränke pro tag

Jarra de acero inoxidable con asas
y tapa de caucho.
Cojinete amortiguador de una
pieza, apto para lavavajillas.
Controles de velocidad variable (no
se muestra).

Stainless steel container with two
handles and rubberized lid.
Dishwasher-safe one-piece jar pad
for easy cleaning.
Variable speed controls (not
shown).

Bol en acier inoxydable avec anses
et couvercle caoutchouté.
Coussin amortisseur d'une pièce,
compatible lave-vaisselle.
Contrôle de vitesse variable (non
représenté).

Behälter und Griffe aus rostfreiem
Stahl und Deckel aus Kautschuk.
Stossdämpfereinheit aus einem
Stück für Spülmaschinen geeignet.
Variable Geschwindigke-
itskontrolle (nicht gezeigt).

CBL10



Tapa para líquidos calientes.
Hot blending lid.
Couvercle pour liquides chauds.
Deckel für heiße Flüssigkeiten.

IDEA!

Ideal para hospitales y grandes comunidades /
Ideal for hospitals and large /
Idéal pour les hôpitaux et les grandes communautés /
Ideal für Krankenhäuser und Großgemeinschaften

REF	Lts	V	W	Hz	
CB15VE	4,0	230	3,75 HP / 2800W	50	1
CAC72	Jarra / Container / Bol / Behälter				1
CBL10					1



6001X Licuadora de servicio pesado / Heavy-Duty Juice Extractor /
Centrifugeuse à usage intensif / Hochleistungs Entsafter

3600 RPM - 1,4 A



REF	V	W	Hz	
6001X	230	330	50/60	1



Cuchilla flotante de acero inoxidable, para extraer el zumo y eliminar la pulpa rápidamente.

Lame flottante en acier inoxydable qui extrait le jus rapidement, réduisant ainsi la quantité de pulpe.

Stainless steel blade speeds up juice flow with faster distribution of pulp.

Messer aus rostfreiem Stahl, zum schnellen Entsaften und Fruchtfleischentfernung.

8,00 - 10,00 L
Preparación máxima horaria / Maximum hourly preparation /
Préparation maximum horaire / Maximierte stündliche Zubereitung

WKS800E Afilador de cuchillos comercial / Commercial Knife Sharpener
Aiguseur électrique commercial / Kommerzieller Messerschärfer



REF	V	W	Hz	A	
WKS800E	230	25	50/60	0,1	1



Dos ruedas de afilar (fino/grueso) y una rueda de pulir.

Afila a un ángulo de 18-22°, el ángulo recomendado por los fabricantes de cuchillos. La rueda de pulir gira en dirección opuesta para remover las asperezas en el filo del cuchillo de manera óptima y lograr un pulido más efectivo

Two grinding wheels (fine/coarse), one stropping wheel.

Grinds at 18-22° angles — optimum angles recommended by knife manufacturers. Stropping wheel also operates in reverse direction, allowing for a more efficient removal of burrs and polishing of the blade.

Deux meules d'affûtage (grains fins/grossiers) et une meule de polissage.

Aiguise à un angle de 18-22°, l'angle recommandé par les fabricants de couteaux. La meule de polissage tourne dans les deux sens, pour un meilleur affilage.

Zwei Schärfräder (fein/grob) und ein Polierrad. Schärfwinkel 18-22°, von den Messerhersteller empfohlen.

Das Polierrad dreht sich in der entgegengesetzten Richtung, um die Schärfrückstände optimal zu entfernen und um eine effiziente Polierung zu erreichen.



Guía de selección: calentadores y retermalizadores /
Rethermalizer and Warmer: selection guide /
Guide de sélection: appareils de remise à température et appareils de maintien à température /
Rethermalisierer und Speisenwärmer im Vergleich Auswahlübersicht

**RETERMALIZADORES / RETHERMALIZERS /
AP. DE REMISE EN TEMPÉRATURE / RETHERMALISIERER**

Diseñado para calentar y mantener alimentos a la temperatura deseada. Incluso permite calentar comidas salidas directamente del refrigerador en menos de 90 minutos.

Designed to take a container of prepared food from a chilled state to a temperature in less than 90 minutes.

Conçu pour chauffer un aliment préparé congelé jusqu'à la température de service en moins de 90 minutes.

Ausgelegt, um einen Behälter mit gekühlten zubereiteten Speisen in weniger als 90 Minuten auf Temperatur zu bringen.

Aplicación
Rethermaliza alimentos fríos. Mantiene calientes los alimentos.

Application
Retherm Chilled Food. Hold Heated Food.

Application
Remise à température des aliments réfrigérés. Tenir les aliments chauffés.

Anwendung
Aufwärmen von gekühlten Speisen. Halten der Temperatur von aufgewärmten Speisen.

	INDUCTION 3D	RETRO	CAYENNE	CAYENNE
Calentadores y retermalizadores / Warmer and rethermalizer / Ap. de remise à température et ap. de maintien à température / Rethermalisierer und Speisenwärmer im Vergleich	✓	✓	✓	✓
Solo calentador / Warmer only / Chauffant seulement / Nur speisenwärmer	-	-	-	-
Potencia (W) / Power (W) / Puissance (W) / Leistung (W)	800	800	800	1000
Calentamiento a través de contacto directo / Direct contact heating system / Système de chauffage par contact direct / Direktkontakt Erhitzungssystem	-	-	✓	✓
Agua / Water / Eau / Wasser	-	✓	✓	✓
Luz indicadora nivel de agua bajo / Low water light / Contrôle du niveau d'eau par voyant lumineux / Wassertiefstandsanzeige	-	-	✓	✓
Inducción / Induction / Induction / Induktion	✓	-	-	-
Capacidad (L) / Capacity (L) / Capacité (L) / Fassungsvermögen (L)	6,6 - 10,4	6,6 - 10,4	6,6 - 10,4	20
Control de Temperatura / Temperature control / Contrôle de température / Temperaturüberwachung	✓	✓	✓	✓

CALENTADORES / WARMERS / CHAUD / SPEISEWÄRMER

Diseñado para mantener calientes las comidas preparadas.

Designed to hold heated prepared foods.

Conçu pour contenir des aliments préparés et chauffés.





Ausgelegt auf das Halten der Temperatur von aufgewärmten zubereiteten Speisen.

Aplicación
Mantiene calientes los alimentos.

Application
Hold Heated Food.

Application
Tenir les aliments chauffés.

Anwendung
Halten der Temperatur von aufgewärmten Speisen.

OLLA ELÉCTRICA / SOUP KETTLE / MARMITE CHAUD / ELEKTRISCHER BUFFERTOP	BAÑO MARÍA / BAIN MARIE / BAIN MARIE / WASSERBAD	CHAFING DISH	BAÑO MARÍA / BAIN MARIE / BAIN MARIE / WASSERBAD
			
-	-	-	-
✓	✓	✓	✓
400	1200	-	-
-	-	-	-
✓	✓	✓	✓
-	-	-	-
-	-	-	●
10	20	9	3,10 - 5,00
✓	✓	-	-

● Con placas de inducción / With induction hob /
Sur plaque induction / Mit Induktionskochplatte

INDUCTION 3D

REHERMALIZER

MIRAGE®



Inducción 3D de bajo consumo (inferior a 180 W), sin necesidad de utilizar agua.
Tiempo de rethermalización rápido (50-60 min).
Los alimentos no necesitan ser precalentados.
Directamente del congelador al Rethermalizador.
Menú de preselección y regulador de temperatura preciso.

Induction 3D basse consommation (inférieure à 180 W), sans nécessité d'utiliser de l'eau.
Temps de rethermalisation rapide (50-60 min).
Les aliments n'ont pas besoin d'être préchauffés.
Directement du congélateur au rethermalisateur.
Menu de présélection et régulateur de température précis.

Low power, 3D induction (less than 180 W), without the need to use water.
Rapid heating time (50-60 min).
Food does not need to be pre-heated.
Directly from the freezer to the Rethermalizer.
Pre-selection menu and precise temperature regulator.

3D-Induktion mit niedrigem Stromverbrauch (weniger als 180 W), Verwendung von Wasser nicht erforderlich.
Schnelle Rethermalisierungszeit (50 - 60 Min.).
Die Speisen brauchen nicht vorgewärmt werden.
Direkt vom Tiefkühler in den Rethermalisierer.
Vorauswahl-Menü und Regler für präzise Temperatureinstellung.

7470210 Retermalizador de inducción Mirage® / Mirage® Induction Rethermalizers /
 Appareil de remise en température à induction Mirage® / Mirage® Induktions Rethermalisierer

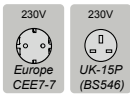

REF	L	cm (Ø x H)	PROF. cm	VOLT. CA / AC	W	A	ENCH. PLUG	Hz	
7470210	6,6	30,3 x 34,2	17,6	230	800	3,5	EU	50/60	1
7470240	6,6	30,3 x 34,2	17,6	230	800	3,5	EU	50/60	1
7470310	6,6	30,3 x 34,2	17,6	230	800	3,5	UK	50/60	1
7470340	6,6	30,3 x 34,2	17,6	230	800	3,5	UK	50/60	1
74110210	10,4	35,3 x 34,2	17,6	230	800	3,5	EU	50/60	1
74110240	10,4	35,3 x 34,2	17,6	230	800	3,5	EU	50/60	1
74110310	10,4	35,3 x 34,2	17,6	230	800	3,5	UK	50/60	1
74110340	10,4	35,3 x 34,2	17,6	230	800	3,5	UK	50/60	1

Natural / Natural / Naturel / Naturfarben
 Rojo / Red / Rouge / Rot

74702D Retermalizador de inducción Mirage® encastrable / Mirage® Drop-In Induction /
 Appareil de remise en température à induction encastrable Mirage® / Mirage® Einbau-Induktionswärmer

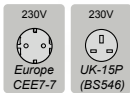

1,8 m



REF	L	cm (Ø x H)	PROF. cm	VOLT. CA / AC	W	A	ENCH. PLUG	Hz	
74702D	6,6	30,3 x 31,3	17,6	230	800	3,5	EU	50/60	1
74703D	6,6	30,3 x 31,3	17,6	230	800	3,5	UK	50/60	1
741102D	10,4	35,3 x 31,3	17,6	230	800	3,5	EU	50/60	1
741103D	10,4	35,3 x 31,3	17,6	230	800	3,5	UK	50/60	1

Drop-In / Drop-In / Encast. / Einbau



88184 Cubetas aptas para Retermalizadores Mirage® 3D /
 Induction ready inserts for Mirage® 3D Induction Rethermalizers /
 Conteneur pour Appareil de remise de température Mirage® 3D /
 Behälter geeignet für Mirage® 3D Rethermalizer



REF	L	PARA OBERTURA FITS OPENING cm	PROF. cm	
88184	6,6	21,6	20,8	6
88204	10,4	26,7	20,8	6

47488 Tapa con visagra y orificio / Lid with hinge / Couvercle / Deckel



REF	PARA FOR	Ø cm	
47488	78184 / 88184	24,0	6
47490	78204 / 88204	28,7	6

Retro



El Rethermalizador Retro calienta los productos con agua, como cualquier baño maría. Calienta la comida fría hasta una temperatura deseada en menos de 90 minutos.

El elemento de base cerámica garantiza un arranque rápido y un rendimiento uniforme. El cuerpo exterior no se calienta durante el uso del Rethermalizador. Los cacillos se venden por separado.

Retro Rethermalizer unit heats products with water, like any bain marie. Heats food from a chilled state to a temperature in less than 90 minutes.

Ceramic base element ensures a fast start-up and consistent performance. Heavy duty exterior body ensures the unit remains cool to the touch while operating. Ladles sold separately.

L'unité de remise à la température Retro chauffe les produits avec de l'eau, comme tout bain marie. Chauffe les aliments d'un état réfrigéré à une température en moins de 90 minutes.

L'élément de base en céramique garantit un démarrage rapide et une performance homogène. L'extérieur ultra-robuste garantit que l'appareil reste frais au toucher tout en fonctionnant.

Der Retro Rethermalisierer erhitzt Speisen mit Wasser wie im Wasserbad. Er erhitzt gekühlte Speisen in weniger als 90 Minuten.





















Keramik-Grundelement garantiert ein schnelles Aufwärmen beim Einschalten und eine gleichmäßige Leistung. Strapazierbare Ummantelung gewährleistet, dass das Gerät sich während des Betriebs kalt anfühlt.

**7217 Retermalizadores Estilo Retro / Retro Stock Pot Kettle Rethermalizers /
 Marmite de remise en température Rétro / Retro-Suppenkessel-Rethermalisierer**

Retro CE

-  Natural /
Natural /
Naturel /
Naturfarben
-  Manzana verde /
Green apple /
Pomme verte /
Grüner Apfel
-  Rojo /
Red /
Rouge /
Rot
-  Blanco perla /
Blanc cassé /
Pearl white /
Perlweiß
-  Negro /
Black /
Noir /
Schwarz



REF		L	VOLT. CA / AC	W	A	ENCH. PLUG	Hz	
7217810		6,6	230	1400	6,1	EU	50/60	1
7217910		6,6	230	1400	6,1	UK	50/60	1
7217835		6,6	230	1400	6,1	EU	50/60	1
7217935		6,6	230	1400	6,1	UK	50/60	1
7217850		6,6	230	1400	6,1	EU	50/60	1
7217950		6,6	230	1400	6,1	UK	50/60	1
7217855		6,6	230	1400	6,1	EU	50/60	1
7217955		6,6	230	1400	6,1	UK	50/60	1
7217860		6,6	230	1400	6,1	EU	50/60	1
7217960		6,6	230	1400	6,1	UK	50/60	1
7217310		10,4	230	1400	6,1	EU	50/60	1
7217410		10,4	230	1400	6,1	UK	50/60	1
7217335		10,4	230	1400	6,1	EU	50/60	1
7217435		10,4	230	1400	6,1	UK	50/60	1
7217350		10,4	230	1400	6,1	EU	50/60	1
7217450		10,4	230	1400	6,1	UK	50/60	1
7217355		10,4	230	1400	6,1	EU	50/60	1
7217455		10,4	230	1400	6,1	UK	50/60	1
7217360		10,4	230	1400	6,1	EU	50/60	1
7217460		10,4	230	1400	6,1	UK	50/60	1

H 34,5 cm

Ø 31 cm
 Ø Max. 42 cm

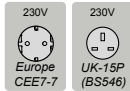

**4980 Cacillos ErgoGrip™ de una sola pieza Kool-Touch® / One-Piece Ergo Grip™ Ladles with Kool-Touch® Handles /
 Louches Ergo Grip™ monobloc avec manche Kool-Touch® / Einteilige Ergo Grip™ Schöpflöffel mit Kool-Touch® Griffen**



REF	ml	BOL/ BOWL Ø cm	TOTAL cm	*cm	
4980322	88,7	7,3	33,3	27,6	6
4980422	118,3	7,9	33,3	27,6	6
4980622	177,4	8,6	33,6	27,6	6
4980822	236,6	10,3	36,2	29,2	6

*Largo desde el fondo del porcionador hasta el gancho del asa /
 *Length from bowl bottom to bend in handle /
 *Longueur du fond du bol à la courbure dans le manche /
 *Länge von der Unterseite der Höhlung bis zur Krümmung im Griff

Construcción de una sola pieza en
 acero inoxidable.
 Asas revestidas de plástico que
 resisten el calor hasta 82° C.
 One-piece construction.
 Stainless steel.
 Plastic-coated handles are heat
 resistant to 82° C.

Construction monobloc Inox.
 Manches plastifiés résistant à 82 °C.
 Einteilige Ausführung.
 Präzise Schöpftteilabmessungen.
 Kunststoffbeschichtete Griffe sind bis
 82 °C hitzebeständig.

**46527 Tapa con visagra y orificio /
 Lid with hinge /
 Couvercle /
 Deckel**

Retro CE



REF	Ø cm	
46527	24,0	6

**46407-2 / 46311-2 Cubetas para retermalizadores Retro /
 Inserts for Retro rethermalizers /
 Conteneur pour appareil de remise de température Retro /
 Behälter für Retro rethermalizer**



REF	L	
46407-2	6,60	1
46311-2	10,40	1



BAÑO MARÍA / BAIN MARIES / BAIN-MARIE / WASSERBAD

Cuerpo de resina reforzada con fibra termofijada auto aislante.
Máxima eficiencia energética. Fácil de limpiar.

Thermoset Fiber-Reinforced Resin Well Selfinsulating.
Maximum energy efficiency. Easy to clean.

Compartiment en résine thermodurcie renforcée Isotherme.
Rendement énergétique maximal. Nettoyage facile.

Faserverstärkte Duroplast-Wanne Selbstisolierend. Maximale
Energieeffizienz. Einfach zu reinigen.

Borde superior diseñado para evitar goteos y drenar la humedad.

Upper rim designed to prevent drips and to drain off the moisture.

Bordure supérieure conçue pour éviter l'égouttement et drainer l'humidité.

Der obere Rand ist darauf ausgelegt, Tropfenbildung zu verhindern und Feuchtigkeit abzuleiten.

Calentador con cúpula usa hasta un 25% menos de energía. La superficie antiadherente evita la acumulación de comida, facilitando la limpieza y prolongando la vida útil. Resistencia incrustada que alarga la vida útil y ayuda a difundir mejor el calor. Concentra la energía dentro del recipiente; produce vapor rápidamente.

Dome Heater. Uses up to 25% less energy. Non-stick surface prevents scale build-up for easy cleaning and longer operating life. Cast-in heating element for longer service life and greater energy transfer. Concentrates energy into the well – producing steam quickly.

Élément chauffant avec dôme qui utilise jusqu'à 25 % d'énergie en moins La surface anti-adhésive empêche l'accumulation de dépôts calcaires pour faciliter le nettoyage et prolonger la durée de vie Élément chauffant moulé pour prolonger la durée de service et augmenter le transfert d'énergie Concentre l'énergie dans le compartiment ; produit rapidement de la vapeur.

Haubenheizung Verbraucht bis zu 25% weniger Energie. Antihaftoberfläche verhindert Kalkablagerungen, vereinfacht das Reinigen u. gewährleistet eine längere Nutzungsdauer Eingegossenes Heizelement stellt längere Nutzungsdauer und besseren Energietransfer sicher Konzentriert die Energie in der Wanne für eine schnelle Dampferzeugung.

Termostato de tubo capilar, suministra energía solamente cuando es necesario, para alcanzar la temperatura deseada.

Capillary tube thermostat, provides energy only when it is required to reach the desired temperature.

Thermostat à tube capillaire, il fournit de l'énergie que lorsque c'est nécessaire pour atteindre la température souhaitée.

Ein Thermostat mit Kapillarrohr liefert Energie nur bei Bedarf, um die gewünschte Temperatur zu erreichen.

Pies antideslizantes / Non-skid Feet /
Pieds antidérapants / Rutschsichere Standfüße



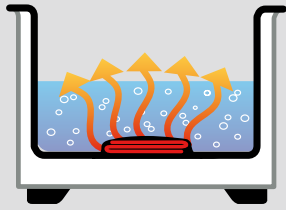

SIN VENTILACIONES
NO VENTS
SANS VENTILATION
KEINE ENTLÜFTUNGSÖFFNUNGEN



ALTA EFICIENCIA
HIGH EFFICIENCY
TRÈS ÉCOÉNERGÉTIQUE
HOHE EFFIZIENZ

**SISTEMA DE CALENTAMIENTO DE CONTACTO DIRECTO / DIRECT CONTACT HEATING SYSTEM /
SYSTÈME DE CHAUFFAGE PAR CONTACT DIRECT / DIREKTKONTAKT-HEIZSYSTEM**

**La última palabra en rendimiento y eficiencia / The ultimate in performance and efficiency /
Performance et efficacité maximales / Ultimative Leistung und Effizienz**

La resistencia está en contacto directo con el agua, transfiriendo el calor de una forma más eficiente. Esto se combina con el exclusivo cuerpo de resina reforzada, permitiendo un máximo aislamiento y máxima eficiencia energética. No necesita ventilación.

The heating element is in direct contact with the water for the most efficient heat transfer possible. This is coupled with Vollrath's exclusive Thermoset fiber-reinforced resin well, which provides superior insulation for maximum energy efficiency. So much heat is saved that there is no need for vents.

L'élément chauffant est en contact direct avec l'eau afin de permettre un transfert de la chaleur le plus efficace possible. De plus, le compartiment exclusif de Vollrath en résine thermodurcie renforcée offre une isolation supérieure rendant possible un rendement écoénergétique maximum. La conservation de chaleur est telle qu'il est inutile d'utiliser des événements.

Das Heizelement befindet sich in direktem Kontakt mit dem Wasser und gewährleistet dadurch einen möglichst effizienten Wärmetransfer. In Verbindung mit Vollraths exklusiver, faserverstärkter Duroplast-Wanne ist für eine hervorragende Isolierung und damit eine maximale Energieeffizienz gesorgt. Es wird so viel Wärme gespart, dass keine Entlüftungsöffnungen notwendig sind.



Mayor capacidad de agua reducen los costos de mano de obra. Mejoran la calidad de la comida manteniendo el máximo calor húmedo.

Increased Water Capacity. Reduce labor costs. Improve food quality by maintaining maximum moist heat.

Capacité d'eau supérieure ayant pour conséquence une diminution des frais de main-d'oeuvre Amélioration de la qualité des aliments grâce au maintien d'un maximal de chaleur humide.

Erhöhtes Wasservolumen Arbeitskosten werden gesenkt. Durch Aufrechterhaltung eines Maximums an feuchter Wärme wird die Speisenqualität verbessert.

Exterior más fresco concentra el calor dentro del receptáculo, no en la superficie exterior ni en el reborde.

Cooler Exterior Concentrates heat inside the well, not to the outside surface and rim.

Extérieur plus frais qui concentre la chaleur à l'intérieur du compartiment et non sur la surface extérieure ou sur le rebord.

Kühlere Außenausführung Konzentriert die Wärme in der Wanne, nicht aber an den Außenflächen oder am Rand.

Cable eléctrico con salida inferior se adapta a la ubicación de la toma de corriente para una instalación segura. Permite controlar la ubicación en 360°. Largo estándar del cable de 183 cm.

Low positioning of electrical cord outlet adapts to the location of the power socket for safe installation. Allows the location to be controlled 360°. Standard cable length of 183 cm.

Câble d'alimentation muni d'une sortie située à la base S'adapte à la prise de courant pour une installation sûre. Permet le positionnement des commandes à 360 degrés. Câble d'une longueur standard de 183 cm.

Unten aus dem Gerät austretendes Netzkabel lässt sich der Steckdosenposition anpassen und ermöglicht so eine sichere Installation Ermöglicht eine 360-Grad Platzierung des Steuerteils. 183 cm langes Standardkabel.

CAYENNE®



72522 Olla Retermalizadora Cayenne® Heat'N'Serve / Cayenne® Heat'N'Serve Rethermalizer /
Ap. de remise en temp. Heat 'N Serve ronds Cayenne® / Runde Cayenne® Heat 'N Serve-Rethermalisierer

CE 800 W - 3,5 A
230 V



HS-11

REF	cm (Ø x H)	L	V	W	ENCH. PLUG	☐
72522	32,0 x 24,5	10,4	230	800	EU	1

Con recipiente interior y tapa con visagra /
With inset, hinged cover /
Avec conteneur et couvercle /
Mit Einsatz, Scharnierdeckel.

78184 Recipiente interior / Insert container /
Conteneur pour appareil de remise en température Heat 'N Serve ronds Cayenne® / Einsatzbehälter

CE



REF	PARA FOR	Ø cm	AL cm	L	☐
78184	72518*	24,0	20,8	6,6	6
78204	72522	28,7	20,8	10,4	6

*Cubeta no apta para Inducción /
*Not induction-ready insert /
*Conteneur non Induction /
Behälter nicht für Induktion geeignet.

47488 Tapa con visagra y orificio / Lid with hinge / Couvercle / Deckel

CE



REF	PARA FOR	Ø cm	☐
47488	78184 / 88184	24,0	6
47490	78204 / 88204	28,7	6



**Retermalizador Cayenne® Heat'N'Serve 1/1 Gastronorm /
 Rethermalizer Cayenne® Heat'N'Serve full size /
 Appareils de remise en temp. Cayenne® Heat'N Serve 1/1 Gastronorme /
 Cayenne® Heat'N Serve-Rethermalisierer in Standardgröße**

72630

CE 1.000 W - 4,3 A
 230 V

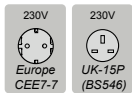

REF	PROFUNDIDAD WELL DEPTH cm	ENCH. PLUG	
72630	16,8	EU	1
72550	16,8	UK	1

Recipiente de resina reforzada con fibra termofijada aislante. Máxima eficiencia energética. Control de termostato /

Thermoset fiber reinforced well — self-insulating with maximum energy efficiency. Capillary Tube Thermostat Control /

Compartiment en résine thermodurcie renforcée – isotherme pour un rendement énergétique maximal. Thermostat à tube capillaire /

Faserverstärkte Duroplastwanne – selbstisolierend und maximale Energieeffizienz. Kapillarrohr-Thermostatregelung.

**72620 Calentador Cayenne® 1/1 Gastronorm / Warmer Cayenne® 1/1 Gastronorm /
 Chauffeur Cayenne® 1/1 Gastronorme / Wasserbad 1/1 Gastronorm Cayenne®**

CE 700 W - 3,0 A
 230 V

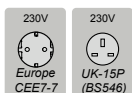

REF	PROFUNDIDAD WELL DEPTH cm	ENCH. PLUG	
72620	16,8	EU	1
72553	16,8	UK	1

Recipiente de resina reforzada con fibra termofijada aislante. Máxima eficiencia energética. Control de termostato /

Thermoset fiber reinforced well — self-insulating with maximum energy efficiency. Capillary Tube Thermostat Control /

Compartiment en résine thermodurcie renforcée – isotherme pour un rendement énergétique maximal. Thermostat à tube capillaire /

Faserverstärkte Duroplastwanne – selbstisolierend und maximale Energieeffizienz. Kapillarrohr-Thermostatregelung.

**72958 Cayenne® Calentador con drenaje / Cayenne® Warmer with Drain /
Réchaud Cayenne® avec vidange / Cayenne® Speisenwärmer mit Ablauf**

CE 1.200 W - 5,2 A
230 V

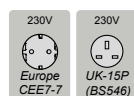

REF	PROFUNDIDAD WELL DEPTH cm	ENCH. PLUG	
72959	16,5	EU	1
72958	16,5	UK	1

Recipiente de acero inoxidable pulido serie 300. Con válvula de drenaje. Capacidad para cubetas de tamaño completo y fraccionales, hasta 10 cm de profundidad.

300 series brushed stainless steel well. Drain valve. Holds up to 10 cm deep pans — full and fractional sizes.

Compartiment en inox brossé série 300. Robinet d'évacuation. Bacs d'une profondeur maximale de 10 cm — grande taille et fractions de taille.

Gebürstete Edelstahlwanne, 300er Serie. Ablaufventil. Nimmt bis zu 10 cm tiefe Schalen auf – Standard- und Bruchteilgrößen.

**P15014 /
P15020**

**Baño maría 1/1 Gastronorm / Baño maría 1/1 Gastronorm con grifo desagüe /
Bain-marie 1/1 Gastronorm / Bain-marie 1/1 Gastronorm with drainage tap /
Bain-marie 1/1 Gastronorme / Bain-marie 1/1 Gastronorme avec robinet de vidange /
Wasserbad 1/1 Gastronorm / Wasserbad 1/1 Gastronorm mit Ablaufhahn**

CE
+30 °C
+90 °C



REF	TIPO / TYPE	V	W	Hz	
P15014	A	230	1200	50/60	1
P15020	A	230	1200	50/60	1

Termostato / Thermostat

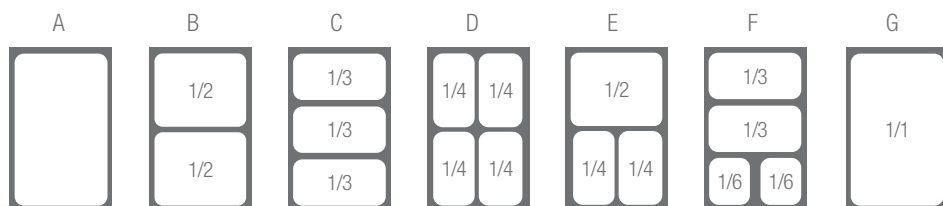

Sin cubetas / Without bags / Sans bacs / Ohne Behälter

Max H 100 mm

P9100 Olla eléctrica para buffet / Soup kettle / Marmite buffet chaud / Elektrischer Buffettopf

CE

Cuerpo de aluminio con baño epoxy.

External aluminium body with epoxy coating.

Corps en aluminium laque epoxy.

Aluminiumkörper mit Epoxybeschichtung.



REF	mm	L	
P910.008	340 x 390	10,0	1

Termostato regulador de temperatura. Resistencia 400 W, 1,9 amperios, 230 V monofase, 50/60 Hz. Tapa de acero inox. Cuba interior de acero inox. con capacidad para 10 litros.

Thermostat pour le réglage de la température. Résistance 400 W, 1,9 ampères, 230 V monophasée, 50/60 Hz. Couverture en acier inox. Cuve intérieure en acier inox. capacité 10 lts.

Thermostat to regulate the temperature. Resistance 400 W, 1,9 amperes, 230 V single phase, 50/60 Hz. St/Steel lid. Inside pool St/Steel, 10 lts. capacity.

Temperaturkontrolle. Kotrolleuchten. Deckel Thermostat regulierbar Heizelement 400W, 1,9 A, 230V, 50/60 Hz. Edelstahldeckel. Innenbehälter aus Edelstahl mit Fassungsvermögen von 10 Liter.



MAQUINARIA /
EQUIPMENT /
EQUIPMENT

P688265 Lámpara mantenedora de comida caliente / Heat shade /
Abat - jour pour lampe chauffante / Wärmelampe

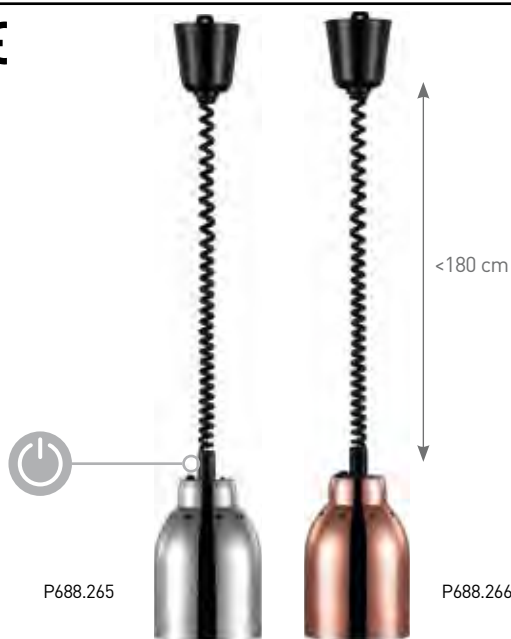

REF		Ø cm	V	W	Hz	
P688.265	Inox / St/Steel / Edelstahl	23	230	250	50/60	1
P688.266	Cobre / Copper / Cuivre / Kupfer	23	230	250	50/60	1

Bombilla no incluida.
Bulb not included.
Ampoule non comprise.
Glühbirne nicht inklusive.

Cable extensible hasta 180 cm.
Cable with rise and fall mechanism upto 180 cm.
Avec cable extensible jusqu'a 180 cm.
Auseinanderziehbares Kabel bis 180 cm.

P6880 Lámpara mantenedora de comida caliente / Heat shade /
Abat - jour pour lampe chauffante / Wärmelampe



REF	Ø cm	V	W	Hz	
P688.045	23	230	250	50/60	4

Aluminio. Con interruptor. Se entrega sin lámpara. Cable extensible hasta 180 cm.

Aluminium avec interrupteur. Livraison sans ampoule. Avec cable extensible jusqu'à 180 cm.

Aluminium with on/off switch. Delivered without bulb. Cable with rise and fall mechanism upto 180 cm.

Aluminium. Mit Schalter. Lieferung ohne Birne. Auseinanderziehbares Kabel bis 180 cm.

P15029 / P15030 Lámpara mantenedora de comida caliente / Heat shade with lamp /
Abat - jour pour lampe chauffante infra-rouge / Wärmelampe



REF	Ø cm	V	W	Hz	
P15.029	23	230	250	50/60	1
P15.030	23	230	250	50/60	1

Cable extensible
Rise&fall cable
Cable extensible
Festes Kabel

Se entrega con lámpara roja
Delivered with red bulb
Livraison avec ampoule rouge
Lieferung mit roter Lampe

Aluminio o cobre. Con interruptor. Se pone en funcionamiento rápidamente y proporciona un calor penetrante sin solidificar la superficie de las salsas. Fácil de instalar. Se entrega con lámpara (250 W max). Versión con cable de mecanismo extensible (máx. 140 cm).

Aluminium ou cuivre. Avec interrupteur. Mise en service rapide. Chaleur pénétrante sans coaguler la surface des sauces, etc. Facile à installer. Livraison avec ampoule (250 W max). Avec cable extensible (max. 140 cm).

Aluminium or copper. With on/off switch. It gives instant direct heat. Provides a penetrating heat without congealing surfaces, gravies, etc. Simple to install. Delivered with bulb (250 W max). Cable with rise and fall mechanism (max. 140 cm).

Aluminium oder Kupfer. Mit Schalter. Schnelles Einschalten und verteilt eine durchdringende Wärme ohne die Oberfläche der Sossen zu verbrennen. Einfache Installation. Lieferung mit Birne (250 W max). Mit ausziehbarem Kabel (máx. 140 cm).

P15031 / P15032 Lámpara mantenedora de comida caliente / Heat shade with lamp /
Abat - jour pour lampe chauffante infra - rouge / Wärmelampe

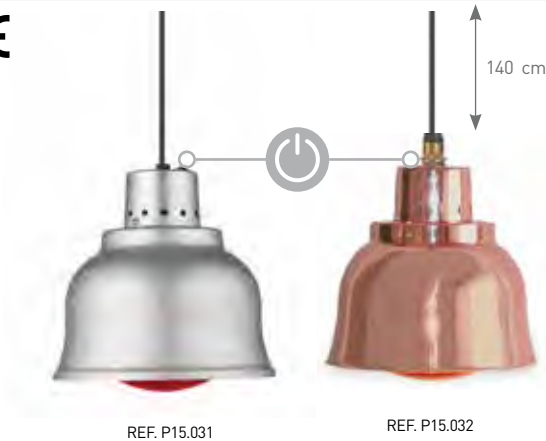

REF	Ø cm	V	W	Hz	
P15.031	23	230	250	50/60	1
P15.032	23	230	250	50/60	1

Cable fijo
Fixed cable
Cable fixe
Festes Kabel

250 W

Se entrega con bombilla roja.
Delivered with red bulb.
Livraison avec ampoule rouge.
Lieferung mit roter Lampe.

Aluminio o cobre.
Aluminium or copper.
Aluminium ou cuivre.
Aluminium oder Kupfer.

P688260 Lámpara mantenedora de comida caliente con mármol / Heat shade with marble /
Abat - jour pour lampe chauffante avec marbre / Wärmelampe mit marmor



REF		cm	H cm	V	W	Hz	
P688.260	Inox / St/Steel / Edelstahl	50 x 45	70	230	250	50/60	1
P688.261	Cobre / Copper / Cuivre / Kupfer	50 x 45	70	230	250	50/60	1

Bombilla no incluida.
Bulb not included.
Ampoule non comprise.
Glühbirne nicht inklusive.

P688250 Lámpara mantenedora de comida caliente / Heat shade /
Abat - jour pour lampe chauffante / Wärmelampe



REF		Ø cm	H cm	V	W	Hz	
P688.250	Inox / St/Steel / Edelstahl	24	70	230	250	50/60	1
P688.251	Cobre / Copper / Cuivre / Kupfer	24	70	230	250	50/60	1

Bombilla no incluida.
Bulb not included.
Ampoule non comprise.
Glühbirne nicht inklusive.

**P5080 Lámpara mantenimiento comida caliente con soporte mesa / Heat shade with table support /
Lampe chauffante avec support / Wärmelampe mit Tischständer**



REF	cm	V	W	Hz	
P508.015	22 x 22 x 65	230	250	50/60	1

Lámpara adaptada para mantener caliente todos platos. Estructura compuesta de lámpara infrarojos con base en acero inoxidable. Bombilla roja (250 W) incluida en el precio.

Appliance adapted to heat and keep warm snacks and ready meals. Structure is composed by an infrared lamp with a stainless steel base. Delivered with red bulb (250 W).

Lampe adaptée pour maintenir au chaud tous vos plats. Structure composée par lampe infrarouge avec base en inoxydable. Livrée avec ampoule rouge (250 W).

Lampe geeignet zum Warmhalten von allen Speisen. Struktur zusammengebaut aus Infrarotbirne mit Gehäuse aus rostfreiem Stahl. Rote Birne (250 W) im Preis inklusive.

**P688600 Placa caliente con lámpara mantenedora de comida caliente / Heating plate with heat shade /
Plaque chauffante avec abat-jour pour lampe chauffante / Heizplatte mit Wärmelampe**

REF	Tipo / Type	cm	H cm	V	W	
P688.600	1 x 1/1	38 x 58	57	230	400	1
P688.620	2 x 1/1	73 x 58	57	230	800	1



P688.600



P688.620

150 W

Bombilla incluida.
Bulb included.
Ampoule comprise.
Glühbirne inklusive.

Acrílico / Acrylic /
Acrylique / Acryl

Termostato regulable hasta 90 °C.
Adjustable thermostat up to 90 °C.
Thermostat réglable jusqu'à 90 °C.
Thermostat regulierbar bis 90 °C.

Vitro-cerámica.
Glass-ceramic.
Vitrocéramique.
Kochfelder.

P15033 / P15034 Bombilla / Bulb only / Ampoule seule / Ersatzbirnen



REF	COLOR / COLOUR / COULEUR / FARBE	W	
P15.033	rojo / red / rouge / Rot	175	1
P710.205	rojo / red / rouge / Rot	250	1
P15.034	blanco / white / blanc / Weiss	175	1
P710.206	blanco / white / blanc / Weiss	250	1

**ESTACIÓN BUFFET TRINCHANTE /
CONTOURED CARVING STATION /
STATION DE DÉCOUPAGE CONCAVE /
GEWELLTE TRANCHIERSTATION**



2 x 175 W (Ref. P15033 / P15034)

Lámparas calentadoras dobles.
Dual heat lamps.
Deux lampes chauffantes.
Zwei Heizlampen.

Pantallas de aluminio para disipar el calor /
Spun aluminum shades for heat dissipation /
Abat-jour en aluminium repoussé pour
dissiper la chaleur /
Schirme aus gedrehtem Aluminium zur
Wärmeabfuhr.

Protección contra aliento con vidrio templado
transparente /
Clear tempered glass customer breath guard /
Pare-haleine en verre trempé transparent /
Durchsichtiger Kundenatemschutz aus
gehärtetem Glas

Marco de acero cromado
altamente resistente /
Heavy-duty steel frame, chrome-plated /
Cadre en acier chromé extra-robuste /
Strapazierfähiger Stahlrahmen,
verchromt.

Piés antideslizantes que ofrecen una mayor estabilidad /
Rubber feet provide stability and protect tabletop /
Les pieds en caoutchouc stabilisent et protègent la table /
Gummifüße sorgen für Stabilität und Schutz der Tischfläche

Atractiva estación trinchantera (para
carnes) con lámparas calentadoras.
Interruptor iluminado de encendido/
apagado en la base.

Station de découpage attrayante
disposant de lampes pour plus
de chaleur durant le service.
Interrupteur lumineux de marche/
arrêt sur la base.

Attractive Carving Station with lamps
for additional heat while serving.
On/off lighted switch on base.

Attraktive Tranchierstation mit
Lampen für zusätzliche Wärme beim
Servieren.
Ein/Aus-Schalter an der Basis.

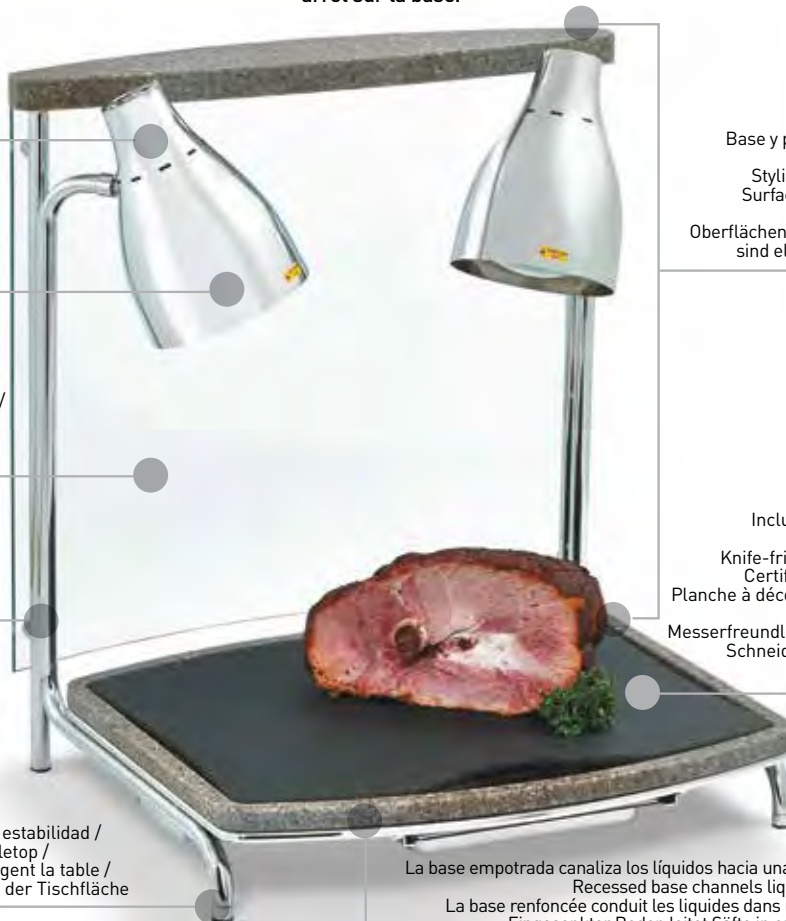

Base y parte superior elegantes con
superficie lisa /
Stylish solid surface base & top /
Surface pleine esthétique (base et
dessus) /
Oberflächen, Schneidfläche und Oberteil
sind elegant und solide ausgeführt

Incluye tabla de corte, apta para
Certificación NSF /
Knife-friendly, dishwasher safe NSF
Certified cutting board included /
Planche à découper certifiée NSF incluse;
apte pour le lave-vaisselle /
Messerfreundliches, spülmaschinenfestes
Schneidbrett mit NSF Zertifizierung
inbegriffen.

La base empotrada canaliza los líquidos hacia una cubeta para goteo retirable /
Recessed base channels liquids into removable drip pan /
La base renfoncée conduit les liquides dans un plateau ramasse-gouttes /
Eingesenkter Boden leitet Säfte in entnehmbare Abtropfwanne ab

**46671 Estación buffet trinchantera / Contoured Carving Station /
Station de découpage concave / Gewellte Tranchierstation**



P15.033

Incluye 2 bombillas de infrarrojos
2 Infrared bulb included
Inclus 2 ampoules infrarouges
Inklusive 2 Infrarot-Lampe



REF	mm	VOLT. CA / AC	ENCH. PLUG	Hz	☐
46671	610 x 559 x 686	230	EU	50/60	1
46672	610 x 559 x 686	230	UK	50/60	1

Bombilla de infrarrojos / Infrared bulb /
Ampoule infrarouge / Infrarot-Lampe

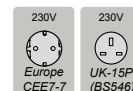

Cable / Cord / Cordon / Kabel
L: 1,8 m.

**25154 Tabla corte para estación buffet trinchantera / Contoured carving station cutting board only /
Planche à découper de station de découpage concave seule / Schwarzes, konturiertes Schneidbrett nur für Fleisch**



REF	mm	Hz	☐
25154	541 x 425 x 12,7	Negro / Black 50/60	1

P15073 / P15074 Placa caliente / Heating plate / Plaque chauffante / Heizplatte



REF	mm	V	W	Hz	
P15.073	600 x 400	230	600	50/60	1
P15.074	530 x 325 (gastronorm 1/1)	230	600	50/60	1

Fabricada en acero inoxidable 18/10. Termostato regulable hasta 75 °C. Con interruptor central y piloto de control.

Habillage en inox 18/10. Thermostat réglable jusqu'à 75 °C. Interrupteur central et voyant de contrôle.

18/10 St/Steel. Adjustable thermostat up to 75 °C. With on / off switch and indicator light.

Hergestellt aus Edelstahl 18/10. Thermostat regulierbar bis 75 °C. Mit zentralem Schalter und Kontrollleuchten.

46110

Elemento eléctrico universal para chafing dish / Universal electric chafing heater / Résistance électrique pour chafers / Universelle Rechaud-Elektroheizung

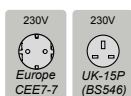

REF	PARA / FOR	V	W	A	ENCH. PLUG	
46110	EU	230	120/230	1.0	EU	1
46115	UK	230	120/230	1.0	UK	1

Dimensiones compatibles con el orificio para combustible estándar. Sized to fit standard fuel opening.

Dimensions compatibles avec l'orifice pour combustible standard. Abmessungen sind kompatibel mit den Öffnungen für Standardbenzin.

P9500

Elemento eléctrico para chafing dish / Electric heating unit for chafing dish / Corps de chauffe pour chafing dish / Elektrisches Element für chafing dish



REF	W	
P950.000	240	1

Para / For / Pour / Für: P379.065, P387.065

P15096 / P15097

Fuente Fondue chocolate / Chocolate fountain / Fontaine à chocolat / Schokoladenbrunnen

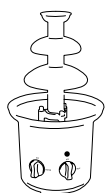

Ref. P15.096

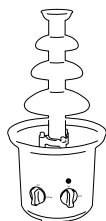

Ref. P15.097

REF	ml	NIVELES / LEVELS / NIVEAUX / EBENEN	V	Hz	Ø cm	H cm	W	
P15.096	700	3	230	50	21	38,0	250	1
P15.097	1200	4	230	50	23	45,0	250	1

Cuerpo y partes de acero inoxidable. Incorpora un regulador de temperatura y un regulador de velocidad. Muy fácil de desmontar y limpiar. Pie regulador para apoyo estable.

Corps et composants en acier inoxydable. Régulateur température et vitesse. Très facile à nettoyer. Pied de régulation pour un appui stable.

St/Steel body and parts. Temperature and speed control. Easy to clean. Adjustable foot for a stable standing.

Gehäuse und Teile aus rostfreiem Stahl. Eingebauter Temperatur- und Geschwindigkeitsregler. Einfach auseinander zu nehmen und zu reinigen. Regulierbarer Fuss für einen stabilen Stand.

P15010

Baño maría chocolate / Chocolate warmer / Chauffe-chocolat / Wasserbad



INOX - ST/STEEL
EDELSTAHL
18/10
Temp. Max 40 °C



REF	UNIDADES / UNITS / UNITÉS / EINHEIT	Lts	V	W	
P15.010	1	3,50	230	250	1

IDEA!

Especial chocolate
Special chocolate
Spécial chocolat
Spezial Schokolade

Nueva gama de carros calientes para banquetes y catering, que le permitirán acercar la cocina allí donde esté el cliente, asegurando la máxima calidad y la entrega de los platos por encima de los 65 °C.

New range of heated trolleys for banquets and other catering events, a range that enables you to take the kitchen to customer, guaranteeing maximum quality and the delivery of dishes at temperatures above 65 °C.

Nouvelle gamme de chariots chauds pour banquetes et service traiteur (catering), pour vous permettre de rapprocher la cuisine du lieu où se trouve le client, en garantissant la qualité maximale et la livraison des plats au-dessus de 65 °C.

Neue Produktpalette von Warmhalteschränken für Banketts und Catering, um die Küche dem Kunden anzunähern, um ihm eine maximale Qualität und eine Speisenslieferung von über 65 °C zu versichern.

**UNIFORMIDAD DE CIRCULACIÓN DEL AIRE CALIENTE / EVEN CIRCULATION OF HOT AIR /
UNIFORMITÉ CIRCULATION AIR CHAUD / EINHEITLICHE HEISLUFTZIRKULATION**

Circulación uniforme y constante del aire gracias a un sistema único que imposibilita el contacto de las cubetas con el fondo o las paredes.

The circulation of air is even and constant thanks to a unique system that makes it impossible for the containers to touch the cabinet base or sides.

La circulation d'air chaud est uniforme et constant grâce à un système unique qui empêche que les bacs touchent le fond ou les parois.

Einheitliche und konstante Heissluftzirkulation dank eines einzigartigen Systems, welches den Kontakt der Behälter mit den Böden oder Wänden unmöglich macht.



1

**AISLAMIENTO EN LANA DE ROCA / ROCKWOOL INSULATION /
 ISOLATION EN LAINE DE ROCHE / ISOLIERUNG MIT STEINWOLLE**

+ DURADERO

Aislamiento térmico en lana de roca evitando la deformación con el calor y ampliando la vida útil del armario.

+ AHORRO ENERGÉTICO

Gracias al extraordinario sistema de aislamiento, se consigue el grado de temperatura deseado, con mayor rapidez y permite conservar el calor durante un periodo de tiempo más prolongado.

+ HIGIÉNICO

Con el sistema de guías monobloc (sin soldaduras) la limpieza interior es mayor, más fácil y rápida.

+LONG LASTING

Thermal insulation provided by rockwool preventing deformation through heat and lengthening the useful life of the cabinet.

+ENERGY SAVING

Thanks to the extraordinary thermal insulation system, the desired temperature is achieved more quickly and the heat is conserved for longer periods.

+HYGIENE

With the exclusive system of monoblock guides (without welds) cleanliness inside is grater, easier and faster.

+DURABLE

Isolation thermique en laine de roche pour éviter la déformation par la chaleur et augmenter la vie utile de l'armoire.

+HYGIÉNIQUE

Grâce au système exclusif de glissières monobloc (sans soudures) le nettoyage intérieur est plus parfait, plus aisé et plus rapide.

+ÉCONOMIE D'ÉNERGIE

Grâce à l'extraordinaire système d'isolation thermique, la température souhaité s'obtient plus rapidement et cela permet de conserver la chaleur pendant une plus longue période de temps.

+ LANGLEBIGKEIT

Hitzeisolierung durch Steinwolle, welche eine Hitzedeformierung ausschliesst und die Gebrauchsdauer verlängert.

+ ENERGIEERSPARNIS

Dank des aussergewöhnlichen Isolierungsystems lässt sich die gewünschte Temperatur schnell erreichen und sie wird für einen längeren Zeitraum beibehalten.

+ HYGIENE

Mit dem Einschubführungssystem Monoblock (ohne Verschweissungen) ist die Reinigung des Inneren besser, einfacher und schneller.

2

CAPACIDAD / CAPACITY / CAPACITÉ / KAPAZITÄT

Guías monobloc (sin soldaduras) para rejillas acero inoxidable y cubetas Gastronorm 2/1 y 1/1. Para platos hasta diámetro 31 cm.

Monoblock guides (without welds) for St/Steel trays and Gastronorm containers 2/1 and 1/1. For dishes up to 31 cm diameter.

Glissières monobloc (sans soudures) pour grilles acier inoxydable et bacs Gastronorm 2/1 et 1/1. Pour des assiettes jusqu'à 31 cm diamètre.

Einschubführungen Monoblock (ohne Verschweißungen) für Roste aus rostfreiem Stahl und Gastronormbehälter 2/1 und 1/1. Für Teller bis zu einem Diameter 31 cm.

FÁCIL MANEJO / EASY HANDLING / MANUPULATION AISÉE / EINFACHE HANDHABUNG

Asas posteriores.
Ruedas pivotantes & 360°.
Dos con freno

Back side handles.
Rotating wheels 360°.
Front wheels with brakes

Poignées postérieures.
Roues pivotantes 360°.
Roues avant avec freins

Griffe hinten.
Räder 360° drehbar.
Zwei mit Bremsen.

3

BLOQUE CALÓRICO / HEAT BLOCK / BLOC CHAUFFANT / HITZEBLOCK

Extraíble sin necesidad de herramientas. Termostato regulador temperatura 0 °C a 100 °C.
Recipiente humidificador integrado.

Extractable without the need of tools
Thermostat for regulation of temperature 0 °C to 100 °C. Provided with humidification container.

Amovible sans besoin d'outils.
Thermostat régulateur de température 0 °C - 100 °C. Bac humidification intégré.

Auseinandernehmbar ohne den Bedarf von Werkzeugen.
Regulierbares Thermostat von 0 °C a 100 °C. Integrierter Behälterluftbefeuchter.

P810

Ref. P81.000

Ref. P81.010

Ref. P81.020

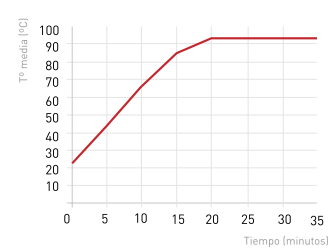
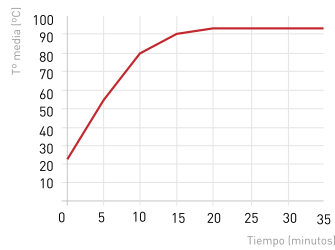
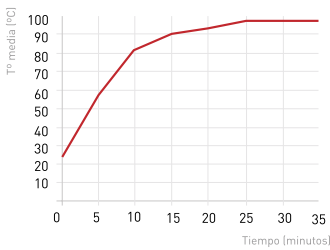

REF	Medidas Guías / Rails Dimensions / Dimensions Glissières / Einschubmasse	Capacidad / Capacity / Capacité / Fassungsvermögen	W	V	
P81.000	GN 2/1	10 GN 2/1 - 20 GN 1/1	3000	230 V II	1
P81.010	GN 2/1	20 GN 2/1 - 40 GN 1/1	3000	230 V II	1
P81.020	GN 2/1	40 GN 2/1 - 80 GN 1/1	4000	230 V II	1



P15027 / P15028 Calentador de platos / Hot cupboards /
 Chauffe - assiettes / Tellerwärmer



+35 °C
 +85 °C

REF	CAPACIDAD PLATOS / CAPACITY PLATES / CAPACITÉ ASSIETTES / TELLERKAPAZITÄT	V	W	
P15.027	60	230	750	1
P15.028	120	1250	1	



Calentadores de platos Cater Chef. Acero inoxidable, doble pared, completamente aislado térmicamente. Con termostato e interruptor con piloto de control. Estantes interiores regulables y extraíbles. Puertas con bisagras muy reforzadas. Diámetro máximo de los platos de 32 cm.

Hot cupboards. St/Steel, wholly insulated. With thermostat and switch with indicator light, removable and ajustable shelves. Door with heavy duty hinges. Diameter max. plates 32 cm.

Chauffe-assiettes. Inox, double paroi, entièrement calorifugée, avec thermostat et interrupteur avec voyant de contrôle, étagères ajustables et amovibles. Porte avec charnières très résistantes. Diametre max. assiettes 32 cm.



Tellerwärmer Cater Chef aus rostfreiem Stahl, Doppelwändig, komplett wärmeisoliert. Mit Thermostat und Schalter mit Kontrollleuchten. Innere Einlegeböden regulierbar und herausnehmbar. Türen mit verstärkten Scharnieren. Max. Tellerdiameter 32 cm.

**HELADO SOFT / SOFT ICE-CREAM /
GLACE À L'ITALIENNE / SOFTAEIS UND FROZEN YOGURT**

SERIE / SERIES / SÉRIE / SERIE	111	131	231	411	431	144	AUTOVEND
ALIMENTACIÓN / POWER SUPPLY / ALIMENTATION / BEFÜLLUNG	GRAVEDAD / GRAVITY / GRAVITÉ / SCHWERKRAFT	GRAVEDAD / GRAVITY / GRAVITÉ / SCHWERKRAFT	GRAVEDAD / GRAVITY / GRAVITÉ / SCHWERKRAFT	BOMBA / PUMP / POMPE / PUMPE	BOMBA / PUMP / POMPE / PUMPE	GRAVEDAD / GRAVITY / GRAVITÉ / SCHWERKRAFT	GRAVEDAD / GRAVITY / GRAVITÉ / SCHWERKRAFT
SABORES / FLAVOURS / PARFUMS / GESCHMACKSRI- CHTUNGEN	1	2+1	2+1	1	2+1	SOFT+ MILKSHAKE	2+1 +TOPPINGS
TIPO / TYPE / TYPE / TYP	SOBREMESA / COUNTERTOP / DE COMPTOIR / TISCHGERÄT	SOBREMESA / COUNTERTOP / DE COMPTOIR / TISCHGERÄT	SUELO / FLOOR / AU SOL / STANDGERÄT	SUELO / FLOOR / AU SOL / STANDGERÄT	SUELO / FLOOR / AU SOL / STANDGERÄT	SOBREMESA / COUNTERTOP / DE COMPTOIR / TISCHGERÄT	SUELO / FLOOR / AU SOL / STANDGERÄT



**BEBIDAS FRÍAS Y GRANIZADOS / COLD & FROZEN BEVERAGE /
BOISSONS FROIDES ET GRANITÉS / KALTGETRÄNKE UND SLUSH EIS**

SERIE / SERIES / SÉRIE / SERIE	118*	112	122	212	412	157	257	218	328
ALIMENTACIÓN / POWER SUPPLY / ALIMENTATION / BEFÜLLUNG	GRAVEDAD / GRAVITY / GRAVITÉ / SCHWERKRAFT	GRAVEDAD / GRAVITY / GRAVITÉ / SCHWERKRAFT	GRAVEDAD / GRAVITY / GRAVITÉ / SCHWERKRAFT	GRAVEDAD / GRAVITY / GRAVITÉ / SCHWERKRAFT	BOMBA / PUMP / POMPE / PUMPE	GRAVEDAD / GRAVITY / GRAVITÉ / SCHWERKRAFT	GRAVEDAD / GRAVITY / GRAVITÉ / SCHWERKRAFT	GRAVEDAD / GRAVITY / GRAVITÉ / SCHWERKRAFT	GRAVEDAD / GRAVITY / GRAVITÉ / SCHWERKRAFT
SABORES / FLAVOURS / PARFUMS / GESCHMACKSRI- CHTUNGEN	1	1	2	1	1	1	1	1	2
TIPO / TYPE / TYPE / TYP	SOBREMESA / COUNTERTOP / DE COMPTOIR / TISCHGERÄT	SOBREMESA / COUNTERTOP / DE COMPTOIR / TISCHGERÄT	SOBREMESA / COUNTERTOP / DE COMPTOIR / TISCHGERÄT	SUELO / FLOOR / AU SOL / STANDGERÄT	SUELO / FLOOR / AU SOL / STANDGERÄT	SOBREMESA / COUNTERTOP / DE COMPTOIR / TISCHGERÄT	SUELO / FLOOR / AU SOL / STANDGERÄT	SUELO / FLOOR / AU SOL / STANDGERÄT	SUELO / FLOOR / AU SOL / STANDGERÄT

**HELADORA CUSTARD / CUSTARD ICE-CREAM /
GLACES CUSTARD / CREMEEIS UND EISCREMES**

SERIE / SERIES / SÉRIE / SERIE	101	202	303
ALIMENTACIÓN / POWER SUPPLY / ALIMENTATION / BEFÜLLUNG	GRAVEDAD / GRAVITY / GRAVITÉ / SCHWERKRAFT	GRAVEDAD / GRAVITY / GRAVITÉ / SCHWERKRAFT	GRAVEDAD / GRAVITY / GRAVITÉ / SCHWERKRAFT
SABORES / FLAVOURS / PARFUMS / GESCHMACKSRI- CHTUNGEN	1	2	3
TIPO / TYPE / TYPE / TYP	SOBREMESA / COUNTERTOP / DE COMPTOIR / TISCHGERÄT	SUELO / FLOOR / AU SOL / STANDGERÄT	SUELO / FLOOR / AU SOL / STANDGERÄT

SOLUCIONES PARA LA HELADERÍA /

ICE-CREAM AND
BEVERAGE SOLUTIONS /

SOLUTIONS POUR
GLACIERS /

SPEISEEIS-
LÖSUNGEN /



Para más detalles descargar
catálogo Stoelting en

For mor details please download
Stoelting catalogue from

Pour plus amples détails, veuillez
télécharger le catalogue Stoelting sur

Für weitere Informationen laden
Sie den Stoelting Katalog herunter

www.pujadas.es



**Máquina de gravedad de sobremesa, un sabor /
Single flavor counter-top, gravity /
Machine à gravité de comptoir, un parfum /
Tischgerät mit Schwerkraftbefüllung, eine Geschmacksrichtung**

E111 / F111



1
SABOR /
FLAVOR /
PARFUM /
GESCHMACKSRICHTUNG

REF	PRODUCCIÓN / PRODUCTION / PRODUCTION / PRODUKTION		CAPACIDAD / CAPACITY / CAPACITÉ / KAPAZITÄT (L)		REFRIGERACIÓN / REFRIGERATION / REFRIGÉRATION / KÜHLUNG	V / HZ / FASE	📦
	L/H	CONES/H	CUBA / CONTAINER / CUVE / BEHÄLTER	CILINDRO / CYLINDER / CYLINDRE / ZYLINDER			
E111X-302I-A	19	175	11,35	2,46	Aire / Air	220 / 50 / I	1
F111X-302I2	30	289	11,35	3,22	Aire / Air	220 / 50 / I	1

Los datos en la tabla tienen carácter indicativo /
The data in the table is for indication only /
Les données du tableau sont indiquées à titre informatif /
Die in der Tabelle aufgeführten Daten sind Richtwerte

Otras combinaciones, consultar /
Ask for other versions /
Autres combinaisons, nous consulter /
Andere Kombination bitte anfragen



GRAVEDAD / GRAVITY /
GRAVITÉ / SCHWERKRAFT

AISI 304

CUERPO EN ACERO INOXIDABLE /
STAINLESS STEEL BODY /
CORPS EN ACIER INOXIDABLE
GEHÄUSE AUS EDELSTAHL

PUERTA TRANSPARENTE /
TRANSPARENT DOOR /
PORTE TRANSPARENTE /
TRANSPARENTE TÜR



DEPÓSITO / HOPPER /
RERVOIR / DIE SPEICHER

SISTEMA DE CONTROL INTELLITEC™ /
INTELLITEC™ CONTROL SYSTEM /
SYSTÈME DE CONTRÔLE INTELLITEC™ /
INTELLITEC™ KONTROLLSYSTEM



3/4 HP POTENCIA / POWER /
PUISSANCE / LEISTUNG



E111 **3.550 Btu / hr** F111 **5.450 Btu / hr**
COMPRESOR / COMPRESSOR /
COMPRESSEUR / KOMPRESSOR

SOBREMESA /
COUNTERTOP /
DE COMPTOIR /
TISCHGERÄT



VENTAJAS / ADVANTAGES / AVANTAGES / VORTEILE

ESPAÑOL

Máquina de helado soft compacta capaz de soportar las condiciones más exigentes de demanda y temperatura gracias a su sistema de refrigeración de alta eficiencia. El sistema Intellitec controla la máquina para obtener los mejores resultados de consistencia y durabilidad. Válvulas autónomas que aseguran usar la máxima cantidad de producto y evitar mermas. Menor coste de mantenimiento por la menor cantidad de partes de desgaste y su mayor durabilidad. Diseñada para una limpieza fácil y rápida. Posibilidad de convertirla en un modelo de suelo con la FS.

ENGLISH

Compact soft ice cream machine able to withstand the most exacting conditions of demand and temperature thanks to its high efficiency refrigeration system. The Intellitec system controls the machine in order to obtain the best results in consistency and durability. Self-closing valves that ensure the maximum product yield and avoid wastage. Lower maintenance costs due to the lower number of parts prone to wear and their greater durability. Designed for quick and easy cleaning. Possibility of converting it into a floor-standing model using the floor.

FRAÇAIS

Machine à glace à l'italienne / soft compacte capable de résister aux conditions les plus exigeantes en matière de température et de demande grâce à son système de réfrigération de haut rendement. Le système Intellitec contrôle la machine pour obtenir les meilleurs résultats en termes de consistance et de durabilité. Valves autonomes qui permettent d'utiliser une quantité maximale de produit et qui évitent les pertes. Coût de maintenance réduit en raison du nombre réduit de pièces d'usure et de leur plus grande durabilité. Conçu pour un nettoyage rapide et facile. Possibilité de le convertir en modèle de sol avec le FS.

DEUTSCH

Kompakte Softeismaschine, die dank ihres hocheffizienten Kühlsystems für starke Beanspruchung und anspruchsvolle Temperaturen geeignet ist. Das Intellitec-System kontrolliert die Maschine, um die besten Ergebnisse für Widerstandsfähigkeit und Langlebigkeit zu erzielen. Autonome Ventile, um die maximale Produktmenge zu nutzen und Verluste zu vermeiden. Geringere Wartungskosten durch weniger Verschleißteile und höhere Widerstandsfähigkeit. Einfache und schnelle Reinigung. Kann mit FS in ein Standgerät verwandelt werden.

**Máquina de gravedad de sobremesa, dos sabores /
Twin twist, counter-top, gravity /
Machine à gravité de comptoir, deux parfums + mélange /
Tischgerät mit Schwerkraftbefüllung, zwei Geschmacksrichtungen + kombiniert**

E131 / F131



2+1

SABOR /
FLAVOR /
PARFUM /
GESCHMACKSRICHTUNG
+
COMBINADO /
COMBINED /
COMBINÉ /
KOMBINIERT

REF	PRODUCCIÓN / PRODUCTION / PRODUCTION / PRODUKTION		CAPACIDAD / CAPACITY / CAPACITÉ / KAPAZITÄT (L)		REFRIGERACIÓN / REFRIGÉRATION / REFRIGÉRATION / KÜHLUNG	V / HZ / FASE	📦
	L/H	CONES/H	CUBA / CONTAINER / CUVE / BEHÄLTER	CILINDRO / CYLINDER / CYLINDRE / ZYLINDER			
E131X-302I2	32	300	11,35 x 2	2,46	Aire / Air	220 / 50 / I	1
F131X-302I2	44	415	11,35 x 2	3,22	Aire / Air	220 / 50 / I	1

Los datos en la tabla tienen carácter indicativo /
The data in the table is for indication only /
Les données du tableau sont indiquées à titre informatif /
Die in der Tabelle aufgeführten Daten sind Richtwerte

Otras combinaciones, consultar /
Ask for other versions /
Autres combinaisons, nous consulter /
Andere Kombination bitte anfragen



GRAVEDAD / GRAVITY /
GRAVITÉ / SCHWERKRAFT

AISI 304

CUERPO EN ACERO INOXIDABLE /
STAINLESS STEEL BODY /
CORPS EN ACIER INOXIDABLE
GEHÄUSE AUS EDELSTAHL

PUERTA TRANSPARENTE /
TRANSPARENT DOOR /
PORTE TRANSPARENTE /
TRANSPARENTE TÜR



DEPÓSITO / HOPPER /
RERVOIR / DIE SPEICHER

SISTEMA DE CONTROL INTELLITEC2™ /
INTELLITEC2™ CONTROL SYSTEM /
SYSTÈME DE CONTRÔLE INTELLITEC2™ /
INTELLITEC2™ KONTROLLSYSTEM



2 x 3/4 HP POTENCIA / POWER /
PUISSANCE / LEISTUNG



E131 **8.600 Btu / hr** F131 **12.000 Btu / hr**
COMPRESOR / COMPRESSOR /
COMPRESSEUR / KOMPRESSOR

SOBREMESA /
COUNTERTOP /
DE COMPTOIR /
TISCHGERÄT

VENTAJAS / ADVANTAGES / AVANTAGES / VORTEILE

ESPAÑOL

Máquina de helado Soft de 2 sabores y combinado compacta capaz de soportar las condiciones más exigentes de demanda y temperatura gracias a su sistema de refrigeración de alta eficiencia. El sistema IntelliTec2 dispone de una pantalla LCD que muestra como operar la máquina. Válvulas autónomas que aseguran usar la máxima cantidad de producto y evitar mermas. Menor coste de mantenimiento por la menor cantidad de partes de desgaste y su mayor durabilidad. Diseñada para una limpieza fácil y rápida. Posibilidad de convertirla en un modelo de suelo con la FS.

ENGLISH

Compact soft ice cream machine with 2 single flavors or in combination, able to withstand the most exacting conditions of demand and temperature thanks to its high efficiency refrigeration system. The IntelliTec2 system has an LCD screen that shows how to operate the machine. Self-closing valves that ensure the maximum product yield and avoid wastage. Lower maintenance cost due to the lower number of parts prone to wear and their greater durability. Designed for quick and easy cleaning. Possibility of converting it into a floor model with the Floor Stand.

FRANÇAIS

Machine de glace à l'italienne / soft 2 saveurs et mélange compacte capable de résister aux conditions les plus exigeantes en matière de demande et de la température grâce à son système de réfrigération à haut rendement. Le système IntelliTec2 possède un écran LCD indiquant comment utiliser la machine. Valves autonomes qui permettent d'utiliser une quantité maximale de produit et qui évitent les pertes. Coût de maintenance réduit en raison du nombre réduit de pièces d'usure et de leur plus grande durabilité. Conçue pour un nettoyage rapide et facile. Possibilité de la convertir en modèle au sol avec le FS.

DEUTSCH

Kompakte Softeismaschine mit 2 Geschmacksrichtungen + kombiniert, die dank ihres hocheffizienten Kühlsystems für starke Beanspruchung und anspruchsvolle Temperaturen geeignet ist. Das IntelliTec2-System bietet einen LED-Bildschirm, der den Maschinenbetrieb anzeigt. Autonome Ventile, um die maximale Produktmenge zu nutzen und Verluste zu vermeiden. Geringere Wartungskosten durch weniger Verschleißteile und höhere Widerstandsfähigkeit. Kann mit FS in ein Standgerät verwandelt werden.

**Máquina de gravedad de suelo, dos sabores /
Twin twist, floor, gravity /
Machine à gravité au sol, deux parfums + mélange /
Standgerät mit Schwerkraftbefüllung, zwei Geschmacksrichtungen + kombiniert**

F231



2+1

SABOR /
FLAVOR /
PARFUM /
GESCHMACKSRICHTUNG
+
COMBINADO /
COMBINED /
COMBINÉ /
KOMBINIERT

REF	PRODUCCIÓN / PRODUCTION / PRODUCTION / PRODUKTION		CAPACIDAD / CAPACITY / CAPACITÉ / KAPAZITÄT (L)		REFRIGERACIÓN / REFRIGÉRATION / REFRIGÉRATION / KÜHLUNG	V / HZ / FASE	1
	L/H	CONES/H	CUBA / CONTAINER / CUVE / BEHÄLTER	CILINDRO / CYLINDER / CYLINDRE / ZYLINDER			
F231X-30212P	44	424	11,35 x 2	3,22	Aire / Air	220 / 50 / I	1

Los datos en la tabla tienen carácter indicativo /
The data in the table is for indication only /
Les données du tableau sont indiquées à titre informatif /
Die in der Tabelle aufgeführten Daten sind Richtwerte

Otras combinaciones, consultar /
Ask for other versions /
Autres combinaisons, nous consulter /
Andere Kombination bitte anfragen



WIFI
VERSION



GRAVEDAD / GRAVITY /
GRAVITÉ / SCHWERKRAFT

PUERTA TRANSPARENTE /
TRANSPARENT DOOR /
PORTE TRANSPARENTE /
TRANSPARENTE TÜR

AISI 304

CUERPO EN ACERO INOXIDABLE /
STAINLESS STEEL BODY /
CORPS EN ACIER INOXIDABLE
GEHÄUSE AUS EDELSTAHL



DEPÓSITO / HOPPER /
RERVOIR / DIE SPEICHER

SISTEMA DE CONTROL INTELLITEC2™ /
INTELLITEC2™ CONTROL SYSTEM /
SYSTÈME DE CONTRÔLE INTELLITEC2™ /
INTELLITEC2™ KONTROLLSYSTEM



3/4 HP POTENCIA / POWER /
PUISSANCE / LEISTUNG



12.000 Btu / hr
COMPRESOR / COMPRESSOR /
COMPRESSEUR / KOMPRESSOR

SUELO /
FLOOR /
AU SOL /
STANDGERÄT

VENTAJAS / ADVANTAGES / AVANTAGES / VORTEILE

ESPAÑOL

El Control ECM y el Sistema de Refrigeración de Alta Eficiencia aseguran la mayor calidad de producto con el menor coste energético. Overrun ajustable para dar la consistencia deseada al helado. Válvulas autónomas que aseguran usar la máxima cantidad de producto y evitar mermas. Menor coste de mantenimiento por la menor cantidad de partes de desgaste y su mayor durabilidad. Diseñada para una limpieza fácil y rápida. Puerta transparente que permite al cliente ver el producto.

ENGLISH

The ECM Control and the High Efficiency Refrigeration System ensure the highest product quality with the lowest energy cost. Adjustable overrun gives the desired consistency to the ice cream. Self-closing valves ensure the maximum product yield and avoid wastage. Lower maintenance cost due to the lower number of parts prone to wear and their greater durability. Designed for quick and easy cleaning. Transparent door that allows the customer to see the product.

FRANÇAIS

Le contrôle ECM et le Système de Réfrigération à Haute Efficacité garantissent la plus haute qualité de produit avec le coût énergétique le plus bas. Overrun réglable pour donner la consistance souhaitée à la glace. Valves autonomes qui permettent d'utiliser une quantité maximale de produit et qui évitent les pertes. Coût de maintenance réduit en raison du nombre réduit de pièces d'usure et de leur plus grande durabilité. Conçue pour un nettoyage facile et rapide. Porte transparente qui permet au client de voir le produit.

DEUTSCH

Die ECM-Steuerung und das hocheffiziente Kühlsystem garantieren höchste Produktqualität bei geringsten Energiekosten. Verstellbarer Overrun für die gewünschte Eiskonsistenz. Autonome Ventile, um die maximale Produktmenge zu nutzen und Verluste zu vermeiden. Geringere Wartungskosten durch weniger Verschleißteile und höhere Widerstandsfähigkeit. Einfache und schnelle Reinigung. Transparente Tür, damit der Kunde das Produkt sehen kann.

**Máquina de gravedad sobremesa de un sabor + bebidas frías /
Counter top, gravity-fed soft-serve ice cream and milkshake machine /
Machine à gravité de comptoir un parfum + boissons froides /
Eismaschine mit Schwerkraft-Einspeisung, Thekeneinheit, eine Geschmackssorte +
kalte Getränke**

F144/SF144

 **1+1**
SABOR /
FLAVOR /
PARFUM /
GESCHMACKSRI-
CHTUNG
+
BATIDO /
SHAKE /
SHAKE /
SHAKE

 GRAVEDAD / GRAVITY /
GRAVITÉ/ SCHWERKRAFT

PUERTA TRANSPARENTE /
TRANSPARENT DOOR /
PORTE TRANSPARENTE /
TRANSPARENTE TÜR

AISI 304
CUERPO EN ACERO INOXIDABLE /
STAINLESS STEEL BODY /
CORPS EN ACIER INOXIDABLE
GEHÄUSE AUS EDELSTAHL

REF	PRODUCCIÓN / PRODUCTION / PRODUCTION / PRODUKTION		CAPACIDAD / CAPACITY / CAPACITÉ / KAPAZITÄT (L)		REFRIGERACIÓN / REFRIGÉRATION / KÜHLUNG	V / HZ / FASE	
	L/H	CONES/H	CUBA / CONTAINER / CUVE / BEHÄLTER	CILINDRO / CYLINDER / CYLINDRE / ZYLINDER			
F144X-30212	26-42	320	11,35 x 2	3,22 x 2	Aire / Air	220 / 50 / I	1
SF144X-30212	26-42	320	11,35 x 2	3,22 x 2	Aire / Air	220 / 50 / I	1

Los datos en la tabla tienen carácter indicativo /
The data in the table is for indication only /
Les données du tableau sont indiquées à titre informatif /
Die in der Tabelle aufgeführten Daten sind Richtwerte

Otras combinaciones, consultar /
Ask for other versions /
Autres combinaisons, nous consulter /
Andere Kombination bitte anfragen



 DEPÓSITO / HOPPER /
REVOIR / DIE SPEICHER /

SISTEMA DE CONTROL INTELLITEC2TM /
INTELLITEC2TM CONTROL SYSTEM /
SYSTÈME DE CONTRÔLE INTELLITEC2TM /
INTELLITEC2TM KONTROLLSYSTEM

 **2 x 3/4 HP** POTENCIA / POWER /
PUISSANCE / LEISTUNG

 **12.000 Btu / hr**

COMPRESOR / COMPRESSOR /
COMPRESSEUR / KOMPRESSOR

SOBREMESA /
COUNTERTOP /
DE COMPTOIR /
TISCHGERÄT



F144



SF144
Incluye batidora /
Includes blender /
Batteur inclus /
Mit Mixer

VENTAJAS / ADVANTAGES / AVANTAGES / VORTEILE

ESPAÑOL

Máquina que combina un cilindro para helado Soft y un segundo cilindro que refrigera y dispensa batidos con la que se pueden ofrecer a los clientes los productos por separado o combinados. La gama SF incluye una batidora de alta capacidad que ahorra tiempo de preparación. Ideal para todo tipo de negocios que no disponen de un gran espacio y quieren ofrecer una gran variedad de productos a sus clientes. Menor coste de mantenimiento por la menor cantidad de partes de desgaste y su mayor durabilidad. Diseñada para una limpieza fácil y rápida.

ENGLISH

Machine that combines a cylinder for Soft-serve ice cream and a second cylinder that refrigerates and dispenses milkshakes which means the products can be offered to the customers separately or combined. The SF range includes a high capacity blender that saves preparation time. Ideal for all types of businesses that do not have a large floor space and wish to offer a wide variety of products to their customers. Lower maintenance cost due to the lower number of parts prone to wear and their greater durability. Designed for quick and easy cleaning.

FRANÇAIS

Machine qui combine un cylindre pour glace à l'italienne et un deuxième cylindre qui réfrigère et distribue des milk-shakes, avec laquelle les produits peuvent être proposés aux clients séparément ou combinés. La gamme SF comprend un batteur haute capacité qui permet de gagner du temps de préparation. Idéal pour tous les types d'entreprises qui ne disposent pas d'un grand espace et veulent offrir une grande variété de produits à leurs clients. Coût de maintenance réduit en raison du nombre réduit de pièces d'usure et de leur plus grande durabilité. Conçue pour un nettoyage rapide et facile.

DEUTSCH

Maschine mit einem Zylinder für Softeis und einem zweiten Zylinder zur Kühlung und Dosierung von Shakes, um den Kunden die Produkte getrennt oder kombiniert anzubieten. Die SF-Reihe umfasst einen Hochleistungsmixer, der Zubereitungszeit spart. Ideal für alle Geschäftsmodelle, die über wenig Platz verfügen und ihren Kunden eine große Produktvielfalt anbieten wollen.

E112

**Dispensador de un sabor de sobremesa, capacidad media /
Counter top. Shake or slush freezer, medium capacity /
Distributeur de boisson, de comptoir, capacité moyenne /
Eisspender, eine Geschmackssorte, Thekeneinheit, mittlere Kapazität**



1

SABOR /
FLAVOR /
PARFUM /
GESCHMACKSRICHTUNG

REF	PRODUCCIÓN / PRODUCTION / PRODUCTION / PRODUKTION		CAPACIDAD / CAPACITY / CAPACITÉ / KAPAZITÄT (L)		REFRIGERACIÓN / REFRIGÉRATION / REFRIGERATION / KÜHLUNG	V / HZ / FASE	1
	L/H	CONES/H	CUBA / CONTAINER / CUVE / BEHÄLTER	CILINDRO / CYLINDER / CYLINDRE / ZYLINDER			
E112X-302	68-45	-	13,73	4,73	Aire / Air	220 / 50 / I	1

GRAVEDAD / GRAVITY /
GRAVITÉ / SCHWERKRAFT

PUERTA TRANSPARENTE /
TRANSPARENT DOOR /
PORTE TRANSPARENTE /
TRANSPARENTE TÜR

AISI 304

CUERPO EN ACERO INOXIDABLE /
STAINLESS STEEL BODY /
CORPS EN ACIER INOXIDABLE
GEHÄUSE AUS EDELSTAHL



DEPÓSITO / HOPPER /
REVOIR / DIE SPEICHER

1/3 HP POTENCIA / POWER /
PUISSANCE / LEISTUNG

6.000 Btu / hr
COMPRESOR / COMPRESSOR /
COMPRESSEUR / KOMPRESSOR

SOBREMESA /
COUNTERTOP /
DE COMPTOIR /
TISCHGERÄT

VENTAJAS / ADVANTAGES / AVANTAGES / VORTEILE

ESPAÑOL

Máquina dispensadora de batidos, bebidas granizadas, smoothies o cocktails de gran capacidad. Sistema de alarma de nivel de mezcla baja. Menor coste de mantenimiento por la menor cantidad de partes de desgaste y su mayor durabilidad. Dispone de modo limpieza automática.

ENGLISH

Large capacity machine for dispensing milkshakes, frozen drinks, smoothies or cocktails. Low mix level alarm system. Lower maintenance costs due to the lower number of parts prone to wear and their greater durability. It has an automatic cleaning mode.

FRANÇAIS

Distributeur grande capacité de milk-shakes, de boissons granités de smoothies ou de cocktails. Le système IntelliTec2 possède un écran LCD qui montre comment utiliser la machine. Système d'alarme de faible niveau de mélange. Coût de maintenance réduit en raison du nombre réduit de pièces d'usure et de leur grande durabilité. Il dispose d'un mode nettoyage automatique.

DEUTSCH

Verkaufsautomat für Shakes, Slush Eis-Getränke, Smoothies oder Cocktails mit hoher Kapazität. Das IntelliTec2-System bietet einen LED-Bildschirm, der den Maschinenbetrieb anzeigt. Hinweissystem für niedrigen Füllstand. Geringere Wartungskosten durch weniger Verschleißteile und höhere Widerstandsfähigkeit. Einfache und schnelle Reinigung.

**Dispensador de un sabor de sobremesa, capacidad media / Counter top. Shake or slush
freezer, medium capacity /
Distributeur de boisson, de comptoir, capacité moyenne /
Eisspender, eine Geschmackssorte, Thekeneinheit, mittlere Kapazität**

F112



SABOR /
FLAVOR /
PARFUM /
GESCHMACKSRICHTUNG

REF	PRODUCCIÓN / PRODUCTION / PRODUCTION / PRODUKTION		CAPACIDAD / CAPACITY / CAPACITÉ / KAPAZITÄT (L)		REFRIGERACIÓN / REFRIGÉRATION / REFRIGÉRATION / KÜHLUNG	V / HZ / FASE	
	L/H	CONES/H	CUBA / CONTAINER / CUVE / BEHÄLTER	CILINDRO / CYLINDER / CYLINDRE / ZYLINDER			
F112X-302	91-68	-	20,35	8,04	Aire / Air	220 / 50 / I	1

 GRAVEDAD / GRAVITY /
GRAVITÉ / SCHWERKRAFT

PUERTA TRANSPARENTE /
TRANSPARENT DOOR /
PORTE TRANSPARENTE /
TRANSPARENTE TÜR

AISI 304

CUERPO EN ACERO INOXIDABLE /
STAINLESS STEEL BODY /
CORPS EN ACIER INOXIDABLE
GEHÄUSE AUS EDELSTAHL

 DEPÓSITO / HOPPER /
REVOIR / DIE SPEICHER

 **1/3 HP** POTENCIA / POWER /
PUISSANCE / LEISTUNG

 **6.000 Btu / hr**
COMPRESOR / COMPRESSOR /
COMPRESSEUR / KOMPRESSOR

SOBREMESA /
COUNTERTOP /
DE COMPTOIR /
TISCHGERÄT



VENTAJAS / ADVANTAGES / AVANTAGES / VORTEILE

ESPAÑOL

Máquina dispensadora de batidos,
bebidas granizadas, smoothies o
cocktails de gran capacidad.
Sistema de alarma de nivel de
mezcla baja.
Menor coste de mantenimiento
por la menor cantidad de partes de
desgaste y su mayor durabilidad.
Dispone de modo limpieza
automática.

ENGLISH

Large capacity machine for
dispensing milkshakes, frozen
drinks, smoothies or cocktails.
Low mix level alarm system.
Lower maintenance costs due to
the lower number of parts prone to
wear and their greater durability.
It has an automatic cleaning mode.

FRANÇAIS

Distributeur grande capacité de
milk-shakes, de boissons granités
de smoothies ou de cocktails Le
système IntelliTec2 possède un
écran LCD qui montre comment
utiliser la machine.
Système d'alarme de faible niveau
de mélange.
Coût de maintenance réduit
en raison du nombre réduit de
pièces d'usure et de leur grande
durabilité.
Il dispose d'un mode nettoyage
automatique.

DEUTSCH

Verkaufsautomat für Shakes,
Slush Eis-Getränke, Smoothies
oder Cocktails mit hoher
Kapazität.
Das IntelliTec2-System bietet
einen LED-Bildschirm, der
den Maschinenbetrieb anzeigt
Hinweissystem für niedrigen
Füllstand.
Geringere Wartungskosten durch
weniger Verschleißteile und
höhere Widerstandfähigkeit.
Einfache und schnelle Reinigung.

521035 / 521030 Batidora helado / Mix-in blenders / Blenders mixeurs / Eis-Shakemschine

0-3000 RPM

REF	cm	H cm	W	Kg	
521035	19 x 20,5	62	560	7,9	1
521030	19 x 20,5	62	560	7,9	1



521035



521030



ESPAÑOL

Ventosas de fijación en la base

- Control de dial (521035) o control de velocidad variable operado con el pie (521030). Deja tus manos libres para una mezcla rápida y fácil
- Protección anti salpicaduras prácticamente irrompible que mantiene el área de trabajo limpia
- Esquinas interiores curvadas que facilitan la limpieza
- Ventilación forzada de aire para aumentar la vida útil del motor y del cojinete.
- Cuerto estanco fabricado en acero inoxidable.
- El motor de velocidad variable ofrece versatilidad ideal para batidos con helados.

ENGLISH

Bottom-mounted stay-in-place suction cups

- Dial Control (521035) or Foot-Operated (521030) variable-speed control leaves your hands free for quick and easy mix-in blending.
- Virtually unbreakable lexan splatter guard keeps work area neat and slides off easily for clean up
- Curved inside corners and easy-to-clean cup-saver mixing head
- Forced air ventilation for long bearing and motor life
- Attractive stainless steel cabinet
- Variable-speed blender motor offers versatility and control
- The versatile blender also doubles to make standard shakes, smoothies, freezes, and sodas

FRANÇAIS

Ventouses de fixation au bas de la machine

- Commande via molette (521035) ou commande au pied (521030) à vitesse variable de façon à avoir les mains libres pour un mélange facile et rapide.
- Pare-éclaboussures en lexan pratiquement incassable, garde la zone de travail propre et se démonte facilement pour le nettoyage
- Coins intérieurs incurvés et tête de mélange facile à nettoyer
- Ventilation forcée pour une longue durée de vie des roulements et des moteurs
- Corps en acier inoxydable élégant
- Le moteur à vitesse variable du mixeur offre polyvalence et contrôle
- Le mélangeur polyvalent permet également de réaliser des milk-shakes des smoothies, des freezes et des sodas.

DEUTSCH

Feste, bodenmontierte Saugnäpfe.

- Drehzahlregelung per Wählscheibensteuerung (521035) oder Fußsteuerung lässt (521030) die Hände frei und gestattet schnelles und einfaches Mixen.
- Ein Spritzschutz aus praktisch unzerbrechlichem Lexan hält den Arbeitsbereich sauber und lässt sich zum Reinigen einfach entfernen.
- Ein Spritzschutz aus praktisch unzerbrechlichem Lexan hält den Arbeitsbereich sauber und lässt sich zum Reinigen einfach entfernen.
- Gerundete Innenkanten und einfach zu reinigender Mixerkopf, der Näpfe spart
- forcierte Lüftung für lange Lebensdauer von Lager und Motor
- Attraktives Edelstahlgehäuse
- Mixermotor mit variabler Drehzahl für Vielseitigkeit und individuelle Steuerung
- Der vielseitige Mixer kann gleichzeitig für normale Shakes, Smoothies, Freezes und Sodas verwendet werden.

GELATO 5K CREA SC

La mantecadora más compacta totalmente automática / The most compact completely automatic ice-cream maker /
La turbine à glace la plus compacte totalement automatique / Die kompakteste vollautomatische Eismaschine

AUTOMATIC

**INOX - ST/STEEL
EDELSTAHL**

70 RPM

REF	VOLUMEN CONTENEDOR / CONTAINER VOLUME / VOLUME CONTENEUR / GROSSER BEHÄLTER L	W	V	Hz	Kg	
P38.250.250	3,20	650	220-240	50	34	1

1,25 Kg / 1,75 L

Capacidad productiva por ciclo.
Production capacity per cycle.
Capacité productive par cycle.
Verbesserte Produktionskapazität
durch zyklischen Betrieb.

12-15 min.

Tiempo de preparación.
Preparation time.
Temps de préparation.
Zubereitungszeit.

5 Kg / 7,00 L

Preparación máxima horaria.
Maximum hourly preparation.
Préparation maximum horaire.
Maximierte stündliche Zubereitung.

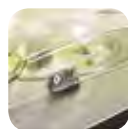

Tapa con imán de seguridad.
Easy clean, drain system.
Couvercle à aimant de sécurité.
Deckel mit Magnetverschluss.



Introducción fácil de ingredientes.
Easy introduction of ingredients.
Introduction facile d'ingrédients.
Einfache Befüllung.



Sistema de desague, fácil limpieza.
Easy clean, drain system.
Système d'écoulement, nettoyage facile.
Wasserablaufsystem, einfach zu reinigen.

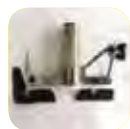

Raspadoras ajustables extraíbles.
Adjustable removable blades.
Raclours réglables amovibles.
Verstellbare Abstreifer, abnehmbar.



Función manual.
Manual function.
Fonction manuelle.
Manueller Betrieb.



4 programas de mantecación.
4 ice-cream making programmes.
4 programmes de malaxage.
Vier Eiszubereitungsprogramme.



4 x 4 programas de conservación.
4 x 4 conserving programmes.
4 x 4 programmes de conservation.
4 x 4 Konservationsprogramme.



Mantecadora para producir, almacenar y distribuir helado.

1. Produce helado de forma automática y en poco tiempo.
2. Conserva el helado dentro de la máquina.
3. Distribuir el helado directamente.

Los 4 programas de mantecación.

- Gelato clásico.
 - Gelato semi-soft.
 - Granita (Granizado).
 - Abatidor rápido de temperatura.
- Control de la densidad automática. La pala se detiene automáticamente cuando el helado está listo.
Desagüe de limpieza.
Cuerpo y pala en acero inoxidable.
Refrigeración por aire. Gas R404.

Ice-cream maker to produce, store and dispense ice-cream.

1. Quickly and automatically produce ice-cream.
2. Conserve the ice-cream inside the machine.
3. Dispense ice-cream directly.

The 4 ice-cream making programmes.

- Classic ice-cream.
- Semi-soft ice-cream.
- Granita (crystallised ice).
- Fast chiller.

Automatic density control. The blade stops automatically when the ice cream is ready.
Cleaning drain.
Stainless steel body and blade.
Air cooling. Gas R404.

Turbine à glace pour produire, conserver et distribuer des glaces.

1. Produit des glaces de façon automatique et en peu de temps.
2. Conserve la glace dans la machine.
3. Distribue directement les glaces.

Les 4 programmes de malaxage.

- Gelato classique.
 - Gelato semi-soft.
 - Granita (Granité).
 - Refroidisseur rapide de température.
- Contrôle de densité automatique. La pale s'arrête automatique quand la glace est prête.
Écoulement de nettoyage.
Corps et pale en acier inoxydable.
Réfrigération à l'air. Gaz R404.

Eismaschine für die Herstellung, Aufbewahrung und Ausgabe von Eis

1. Automatische, schnelle Eisherstellung
2. Aufbewahrung des Eis in der Maschine
3. Ausgabe des Eis direkt aus der Maschine

Die vier Eiszubereitungsprogramme

- Klassisches Eis
- Halbweiches (semi-soft)Eis
- Granita (Slush - sizilianische Eisspeise).
- Schnellfrierverfahren

Automatische Kontrolle der Festigkeit. Die Rührklinge stoppt automatisch, wenn das Eis fertig ist.
Ablaufreinigung.
Körper und Klinge aus rostfreiem Stahl.
Luftkühlung. Gas R404

GELATO 5K SC

Mantecedora / Ice-cream maker / Turbine à glace / Eismaschine

INOX - ST/STEEL
EDELSTAHL

70 RPM



1. Tapa con imán de seguridad.
Lid with safety magnet.
Couvercle à aimant de sécurité.
Deckel mit Magnetverschluss.
2. Introducción fácil de ingredientes.
Easy introduction of ingredients.
Introduction facile d'ingrédients.
Einfache Befüllung.
3. Sistema de desague, fácil limpieza.
Easy clean, drain system.
Système d'écoulement, nettoyage facile.
Wasserablaufsystem, einfach zu reinigen.
4. Raspadoras ajustables extraíbles.
Adjustable removable blades.
Raclours réglables amovibles.
Verstellbare Abstreifer, abnehmbar.

REF	VOLUMEN CONTENEDOR / CONTAINER VOLUME / VOLUME CONTENEUR / GROSSER BEHÄLTER L	W	V	Hz	Kg	
P38.240.250	3,20	600	220-240	50	34	1

Mantecedora para producir helados y sorbetes.

Control de la densidad automática. La pala se detiene automáticamente cuando el helado está listo. Desagüe de limpieza. Cuerpo, cubeta fija y pala (con insertos reemplazables) en acero inoxidable. Refrigeración por aire. Gas R404.

Ice-cream maker to produce ice-cream and sorbets.

Automatic density control. The blade stops automatically when the ice-cream is ready. Drain for cleaning. Body, fixed pail and blade (with replaceable inserts) in stainless steel. Air cooled. Gas R404.

Turbine à glace pour produire des glaces et sorbets.

Contrôle automatique de densité. La pale s'arrête automatiquement quand la glace est prête. Écoulement de nettoyage. Corps, cuve fixe et pale (à inserts interchangeables) en acier inoxydable. Réfrigération par air. Gaz R404.

Eismaschine für die Herstellung von Eis und Sorbets

Automatische Kontrolle der Festigkeit. Die Klinge stoppt automatisch, wenn das Eis fertig ist. Reinigungsablauf Körper, Eisbehälter und Schaufeln (mit auswechselbaren Einsätzen) Edelstahl Luftkühlung. Gas R404.

1,25 Kg / 1,75 L

Capacidad productiva por ciclo.
Production capacity per cycle.
Capacité productive par cycle.
Verbesserte Produktionskapazität durch zyklischen Betrieb.

12-15 min.

Tiempo de preparación.
Preparation time.
Temps de préparation.
Zubereitungszeit.

5 Kg / 7,00 L

Preparación máxima horaria.
Maximum hourly preparation.
Préparation maximum horaire.
Maximierte stündliche Zubereitung.

IDEA!

Ideal para los pequeños restaurantes.
Ideal for small restaurants.
Idéal pour les petits restaurants.
Ideal für kleine Restaurants.



GELATO 3K TOUCH

Mantecedoras / Ice-cream makers / Turbines à glace / Eismaschine

INOX - ST/STEEL
EDELSTAHL

63 RPM



1. Tapa con imán de seguridad.
Lid with safety magnet.
Couvercle à aimant de sécurité.
Deckel mit Magnetverschluss.
2. Introducción fácil de ingredientes.
Easy introduction of ingredients.
Introduction facile d'ingrédients.
Einfache Befüllung.
3. Sistema de desague, fácil limpieza.
Easy clean, drain system.
Système d'écoulement, nettoyage facile.
Wasserablaufsystem, einfach zu reinigen.
4. Raspadoras ajustables extraíbles.
Adjustable removable blades.
Raclours réglables amovibles.
Verstellbare Abstreifer, abnehmbar.

REF	VOLUMEN CONTENEDOR / CONTAINER VOLUME / VOLUME CONTENEUR / GROSSER BEHÄLTER L	W	V	Hz	Kg	
P38.550.250	1,70	350	220-240	50	21	1

Mantecedora para producir helados y sorbetes.

Control de la densidad automática. La pala se detiene automáticamente cuando el helado está listo. Cuerpo, cubeta fija y pala (con insertos reemplazables) en acero inoxidable. Refrigeración por aire. Gas R404.

Ice-cream maker to produce ice-cream and sorbets.

Automatic density control. The blade stops automatically when the ice-cream is ready. Body, fixed pail and blade (with replaceable inserts) in stainless steel. Air cooled. Gas R404.

Turbine à glace pour produire des glaces et sorbets.

Contrôle automatique de densité. La pale s'arrête automatiquement quand la glace est prête. Corps, cuve fixe et pale (à inserts interchangeables) en acier inoxydable. Réfrigération par air. Gas R404.

Eismaschine für die Herstellung von Eis und Sorbets

Automatische Kontrolle der Festigkeit. Die Klinge stoppt automatisch, wenn das Eis fertig ist. Körper, Eisbehälter und Schaufeln (mit auswechselbaren Einsätzen) Edelstahl Luftkühlung. Gas R404.

0,8 Kg / 1,20 L

Capacidad productiva por ciclo.
Production capacity per cycle.
Capacité productive par cycle.
Verbesserte Produktionskapazität durch zyklischen Betrieb.

12-15 min.

Tiempo de preparación.
Preparation time.
Temps de préparation.
Zubereitungszeit.

3 Kg / 4,40 L

Preparación máxima horaria.
Maximum hourly preparation.
Préparation maximum horaire.
Maximierte stündliche Zubereitung.

GELATO CHEF 5L AUTOMATIC

Mantecadoras / Ice-cream makers / Turbines à glace / Eismaschine

INOX - ST/STEEL

EDELSTAHL

63 RPM



1. Tapa con imán de seguridad.
Lid with safety magnet.
Couvercle à aimant de sécurité.
Deckel mit Magnetverschluss.
2. Temporizador e interruptor refrigeración.
Timer and cooling switch.
Temporisateur et interrupteur réfrigération.
Zeitschaltuhr für Gefrierprozess.
3. Cubeta extraíble (aluminio).
Removable pail (aluminium).
Cuve amovible (aluminium).
Herausnehmbarer Behälter (Aluminium).
4. Raspadoras extraíbles.
Removable blades.
Raclours amovibles.
Herausnehmbare Abstreifer.

REF	VOLUMEN CONTENEDOR / CONTAINER VOLUME / VOLUME CONTENEUR / GROSSER BEHÄLTER L	W	V	Hz	Kg	
P36.790.250	2,50	280	220-240	50/60	20	1

Mantecedora para uso profesional.
Control de la densidad automática. La pala se detiene automáticamente cuando el helado está listo.
Cuerpo, cubeta fija y pala (con insertos reemplazables) en acero inoxidable.
Timer mecánico de 60 minutos.
Refrigeración por aire. Gas R404.

Turbine à glace à usage professionnel.
Contrôle automatique de densité. La pale s'arrête automatiquement quand la glace est prête.
Corps, cuve fixe et pale (à inserts interchangeables) en acier inoxydable.
Minuteur mécanique de 60 minutes.
Réfrigération par air. Gas R404.

Ice-cream maker for professional use.
Automatic density control. The blade stops automatically when the ice-cream is ready.
Body, fixed pail and blade (with replaceable inserts) in stainless steel.
60 minute mechanical timer.
Air cooled. Gas R404.

Eismaschine für die professionelle Nutzung.
Automatische Kontrolle der Festigkeit. Die Klinge stoppt automatisch, wenn das Eis fertig ist.
Körper, Eisbehälter und Schaufeln (mit auswechselbaren Einsätzen) Edelstahl.
Mechanische Zeitschaltuhr 60 Minuten.
Luftkühlung. Gas R404.

1 Kg / 1,50 L

Capacidad productiva por ciclo.
Production capacity per cycle.
Capacité productive par cycle.
Verbesserte Produktionskapazität durch zyklischen Betrieb.

20-30 min.

Tiempo de preparación.
Preparation time.
Temps de préparation.
Zubereitungszeit.

2 Kg / 3,20 L

Preparación máxima horaria.
Maximum hourly preparation.
Préparation maximum horaire.
Maximierte stündliche Zubereitung.

COMPARATIVA / COMPARISON / COMPARATIF / VERGLEICH

GELATO 5K
CREA SC



GELATO 5K
SC



GELATO 3K
TOUCH



GELATO CHEF 5L
AUTOMATIC



Alimentación / Power supply / Alimentation / Befüllung	220-240 V 50 Hz	220-240 V 50 Hz	220-240 V 50 Hz	220-240 V 50/60 Hz
Potencia / Power / Puissance / Leistung	650 W	600 W	350 W	280 W
Revoluciones por minuto / Revolutions per minute / Tours par minute / Umdrehungen pro Minute	70 RPM	70 RPM	63 RPM	63 RPM
Volumen contenedor / Container volume / Volume conteneur / Behältergröße	3,20 L	3,20 L	1,70 L	2,50 L
Desagüe / Drain / Vidange / Wasserablaufsystem	✓	✓	X	X
Cubeta extraíble / Removable pail / Cuve amovible / Herausnehmbarer Behälter	X	X	✓	✓
Capacidad productiva por ciclo / Production capacity per cycle / Capacité productive par cycle / Verbesserte Produktionskapazität durch zyklischen Betrieb	1,25 Kg / 1,75 L	1,25 Kg / 1,75 L	0,8 Kg / 1,20 L	1 Kg / 1,50 L
Tiempo de preparación / Preparation time / Temps de préparation / Zubereitungszeit	12-15 min.	12-15 min.	12-15 min.	20-30 min.
Preparación máxima horaria / Maximum hourly preparation / Préparation maximum horaire / Maximierte stündliche Zubereitung /	5 Kg / 7,00 L	5 Kg / 7,00 L	3 Kg / 4,40 L	2 Kg / 3,20 L
Programa de producción y conservación automática / Automatic production and preservation programme / Programme de production et conservation automatique / Programm für die automatische Produktion und Lagerung	✓	X	X	X
Dimensiones / Dimensions / Dimensions / Abmessungen	445 x 480 x 395 mm	445 x 480 x 395 mm	340 x 430 x 250 mm	450 x 320 x 315 mm
Peso neto / Net weight / Poids net / Nettogewicht	34 Kg	34 Kg	21 Kg	20 Kg

GELATO 12K

Mantecedora de suelo / Floor Ice-Cream maker / Turbine à glace au sol / Stand-Eismaschine

INOX - ST/STEEL
EDELSTAHL

60 - 130 RPM



12K ofrece funciones avanzadas pero de fácil uso. Máquina de gran potencia con sistema de extracción frontal. Ofrece la posibilidad de cambiar la velocidad de rotación (60-130 rpm) de la pala de mezclas, controlada por un inversor electrónico y fabricada en acero inoxidable AISI 304, con rasquetas ajustable. Refirgerada por aire.

12K Highlights various advanced functions, but remains very easy to use. It is a very powerful machine with frontal production extraction system. It is possible to vary the rotation speed (60-130 rpm) of the mixing paddle. The mixing paddle motor is controlled with an electronic inverter.

The AISI 304 stainless steel mixing paddle features adjustable scrapers. Air cooling.

12K offre des fonctions avancées mais faciles à utiliser. Machine d'une grande puissance avec système d'extraction frontale. Offre la possibilité de changer la vitesse de rotation (60-130 rpm) de la pale de mélange, contrôlée par un inverseur électronique et fabriquée en acier inoxydable AISI 304, avec racloirs réglables. Réfrigération par air.

12K bietet erweiterte Funktionen mit einfacher Handhabung. Hochleistungsmaschine mit Frontalentnahme. Bietet die Möglichkeit, die Rotationsgeschwindigkeit des Mixstabs zu ändern (60-130 rpm). Der Mixstab wird durch einen elektronischen Wechselrichter aus Edelstahl AISI 304 kontrolliert und ist mit verstellbaren Schabern ausgestattet. Luftkühlung.



REF	VOLUMEN CONTENEDOR / CONTAINER VOLUME / VOLUME CONTENEUR / GROSSER BEHÄLTER LTS	W	V	Hz	Kg	
P38.150.250	6,00	1300	220-240	50	74	1

2,5 KG

Capacidad productiva por ciclo.
Production capacity per cycle.
Capacité productive par cycle.
Verbesserte Produktionskapazität durch zyklischen Betrieb.

10-12 min.

Tiempo de preparación.
Preparation time
Temps de préparation.
Zubereitungszeit.

12 Kg / 18,00 L

Preparación máxima horaria.
Maximum hourly preparation.
Préparation maximum horaire.
maximierte stündliche Zubereitung.



Ruedas. Dos con freno.
Castors. Two with brakes.
Roulettes. Deux avec freins.
Räder. Zwei mit Bremsen.





**INOX - ST/STEEL
EDELSTAHL**



2000 RPM

2 velocidades (1-2 minutos).
2 speeds (1-2 minutes).
2 vitesses (1-2 minutes).
2 geschwindigkeiten (1-2 minuten).

FRIX'AIR

**Emulsionador y procesador de alimentos / Food emulsifier and processor /
Émulsionneur et processeur d'aliments / Emulgator und Küchenmaschine**

REF	W	V	Hz	Kg	
P94.500.250	600	220-240	50/60	21	1

Procesador profesional que permite emulsionar, mezclar y triturar tanto alimentos congelados como frescos.

Frix'Air funciona con recipientes monodosis de 180 ml con muchas ventajas:

- Máxima higiene.
- Congelación muy rápida.
- Disponibilidad inmediata de varias preparaciones.
- Garantiza la cadena de frío.
- Ocupan poco espacio.
- Apilables.

Robot professionnel à émulsionner, mixer et mouliner des aliments surgelés ou frais.

Frix'Air fonctionne à l'aide de récipients monodose de 180 ml offrant de nombreux avantages :

- Hygiène maximum.
- Congélation très rapide.
- Disponibilité immédiate de plusieurs préparations.
- Garantit la chaîne du froid.
- Prend peu de place.
- Empilables.

Professional processor that allows emulsifying, mixing and blending of both frozen and fresh food.

Frix'Air works with 180 ml single-dose containers with many advantages:

- Maximum hygiene.
- Very quick freezing.
- Immediate availability of various preparations.
- It guarantees the cold chain.
- They take up little space.
- Stackable.

Profi-Processor, zum Emulgieren, Mischen und Zerkleinern von sowohl gefrorene und als auch frische Lebensmittel.

Frix'Air arbeitet mit 180 ml Einzelbehältern mit vielen Vorteilen:

- Maximale Hygiene.
- Sehr schnelles Einfrieren.
- Sofortige Verfügbarkeit der verschiedenen Zubereitungen.
- Gewährleistet Kühlkette.
- Raumsparend.
- Stapelbar.



Ideal para preparar mousses, sorbetes, helados, salsas, sopas, cócteles y aperitivos.
Ideal for preparing mousses, sorbets, ice-creams, sauces, soups, cocktails and apéritifs.
Idéal pour préparer des mousses, sorbets, glaces, sauces, soupes, cocktails et apéritifs.
Ideal für die Herstellung Mousses, Sorbets, Eis, Soßen, Suppen, Cocktails und Aperitifs.



**H.A.C.C.P.
NO PROBLEM**

Colores / Colours / Couleurs / Farben



Cada pack contiene 10 u. de cada color.
Each pack contains 10 units of each colour.
Chaque pack contient 10 u. de chaque couleur.
Jedes Set enthält zehn Stück jeder Farbe.

**Set recipientes Frix'Air en plástico para congelador y microondas /
Set of Frix'Air plastic containers for freezers and microwaves /
Set récipients Frix'Air en plastique pour congélateur et micro-ondes /
Plastikbehälter Frix'Air zum Einfrieren und für die Mikrowelle**

REF	ml	Ø mm	H mm	
P99.00.000	180	72	95	50

Accesorios incluidos:
2 Cuchillas de acero inoxidable.
1 Cuchilla de plástico.
2 Junta protectora.
2 Lleva recipientes en acero.
5 Recipientes de plástico con tapa.
1 Desmontador de cuchilla.

Accessoires inclus :
2 lames en acier inoxydable.
1 lame en plastique.
2 joints protecteurs.
2 Muni de récipients en acier.
5 Récipients en plastique avec couvercle.
1 Outil démontage de lame.

Accessories included:
2 St/Steel blades.
1 Plastic blade.
2 Protective seals.
2 Stainless steel containers.
5 Plastic containers with lid.
1 Blade remover.

Zubehör im Lieferumfang enthalten:
2 Edelstahlklingen.
1 Kunststoffmesser.
2 Schutzstecker
2 Stahlbehälter eingeschlossen.
5 Kunststoffbehälter mit Deckel.
1 Abnehmbare Klinge.



Fácil identificación y separación de diferentes preparaciones.
Easy for identification and separation of different foodstuffs.
Identification et séparation faciles des différentes préparations.
Einfaches Erkennen und Unterscheiden unterschiedlicher Zubereitungen.

VER PRODUCTOS EN / SEE PRODUCTS ON / VOIR PRODUITS EN PAGE / SIEHE PRODUKTE IN

**RACIONADOR HELADO / ICE CREAM SCOOP /
CUILLÈRE À GLACE / EISKUNGELPORTIONIERER**

P. 238





MAQUINARIA /
EQUIPMENT /
EQUIPMENT

GREY SOUL



P. 364

WATER



P. 365

OCEAN



P. 366

GOLDEN



P. 367

VERSATIL



P. 368

STYLISH



P. 369

CLASSIC



P. 369

NATURAL



P. 370

TERRACOTA



P. 371

STONE



P. 374

ELEGANCE



P. 375

MEDITERRANEAN



P. 376

COLORS



P. 377

ZEN



P. 378

SHELL

N



P. 379

BLANCHE

N



P. 380

FONTANA

N



P. 380

OLA

N



P. 381

SHARING



P. 382

CANON



P. 384

LIFE



P. 385

VENUS



P. 386

COMPLET TABLE



P. 387

MELAMINA /
MELAMINE /
MÉLAMINE

PASTRY



P. 389

WOOD



P. 390

STONE BOARD



P. 392

GN CLASSIC. COLORS



P. 394

GN CLASSIC. BLACK



P. 395

GN SLIM



P. 396

GN CLASSIC. WHITE



P. 398

STANDS



P. 399

MINI



P. 400

ASHTRAYS



P. 403

MELAMINA Y PRESENTACIÓN / MELAMINE & PRESENTATION / MÉLAMINE ET PRÉSENTATION / MELAMIN UND PRÄSENTATION



ESPAÑOL

La melamina es una resina Sintética que se endurece y toma forma después de un proceso de calentamiento. Es un material muy utilizado en el servicio de mesa y presentación por sus propiedades.

ENGLISH

Melamine is a synthetic resin Which becomes harden and Formed after heating. It is highly recommended for table & buffet service for its properties.

FRANÇAIS

La mélamine est une résine Synthétique qui se durcit et prend-forme après un processus spécial de Chauffage. Très utilisée dans le service de table et buffet par ses propriétés.

DEUTSCH

Melamin ist ein kunstharz, welches sich verhärtet und nach einem erhitzungsprozess eine form annimmt. Aufgrund seiner eigenschaften ist es ein vielbenutztes material für den tischservice und die präsentation.

CARACTERÍSTICAS / MAIN FEATURES / PRINCIPALES CARACTÉRISTIQUES / PRODUKTMERKMALE

Contacto con alimentos: certificado por sgs
Condiciones de trabajo: entre -20°C y +70°C

Food contact approved: certified by sgs
Withstands temperatures: -20°C & +70°C

Contact avec aliments: certifié par sgs
Températures entre: -20°C et +70°C

Kontakt mit lebensmitteln: zertifiziert durch sgs
Arbeitstemperaturen: zwischen -20°C und +70°C

PROPIEDADES / PROPERTIES / PROPRIÉTÉS / EIGENSCHAFTEN

Resistente al calor
Resistente a la corrosión
No tóxico
Inodoro
Ligero e indeformable
Poco conductor del calor

Heat resistant
Corrosion resistant
Non-toxic
Non-odorous
Light weight and free form deformation
Low heat conductivity

Résistante à la chaleur
Résistante à la corrosion
Non-toxique
Inodore
Légère et indéformable
Baisse conductivité de la chaleur

Hitzebeständig, resistent gegen korrosion,
nicht giftig, geruchlos, leicht und unverformbar,
Geringe wärmeleitung

USOS / USES / USAGES / GEBRAUCH

No recomendada / not recomendod /
Non recommandée / nicht empfohlen

Microondas
Horno
Directo al fuego
Aceite y productos químicos

Microwave
Oven
Direct flame
Oil and chemical products

Micro-ondes
Four
Direct au feu
Huile ou produits chimiques

Mikrowellen
Öfen
Direkte flamme
Öl und chemische produkte



P22308 Plato tapas / Tapas dish / Plat à tapas / Tapas Teller



REF	Ø cm	H cm	
P22.308	14,0	2,5	1
P22.309	16,5	2,8	1

P22306 Plato / Plate / Assiete / Teller



REF	Ø cm	H cm	
P22.306	19	2	1
P22.307	21,5	2,5	1

P22303 Bol redondo / Round bowl / Bol rond / Runde Schüssel



P22.303

P22.304

REF	Ø cm	H cm	
P22.303	14,5	5,5	1
P22.304	24	6	1

P22305 Bol cónico / Conical bowl / Bol conique / Konische Schüssel



REF	Ø cm	H cm	
P22.305	12	6,5	1

P22301 Fuente oval / Oval serving dish / Plat ovale / Ovale Buffetschale



REF	cm	H cm	
P22.301	29,5 x 18	3,5	1
P22.302	34,5 x 22	4	1



P22318 Plato / Plate / Assiete / Teller



REF	Ø cm	H cm	
P22.318	25,0	1,5	1
P22.319	27,5	1,5	1
P22.320	30,0	1,5	1

P22321 Plato hondo / Deep dish / Assiette creuse / Tief Teller



REF	cm	H cm	
P22.321	23 x 17,5	6,5	1

DEEP BLUE

P22332 Plato presentación / Serving plate / Assiette présentation / Präsentierteller-Teller



REF	cm	H cm	
P22.332	30 x 28,5	4,5	1



P22316 Bol redondo / Round bowl / Bol rond / Runde Schüssel

REF	Ø cm	H cm	
P22.316	17	5	1



P22317 Plato hondo / Deep dish / Assiette creuse / Tief Teller

REF	Ø cm	H cm	
P22.317	22,5	5	1



P22314 Plato / Plate / Assiete / Teller

REF	Ø cm	H cm	
P22.314	22	2	1
P22.315	27	2	1



P22313 Bandeja rectangular / Rectangular tray / Plateau rectangulaire / Rechteckiges Tablett

REF	cm	H cm	GN	
P22313	53,0 x 32,5	2	1/1	1
P22312	32,5 x 26,5	2	1/2	1
P22310	32,5 x 17,6	2	1/3	1
P22311	53,0 x 16,5	2	2/4	1





P22344 Plato / Plate / Assiete / Teller



REF	Ø cm	H cm	
P22.344	23,0	3,0	1
P22.345	27,5	3,5	1
P22.346	32,0	4,0	1

P22347 Plato presentación / Serving plate / Assiette présentation / Präsentierteller-Teller



REF	cm	H cm	
P22.347	29 x 26,5	1,5	1

P22348 Fuente oval / Oval serving dish / Plat ovale / Ovale Buffetschale



REF	cm	H cm	
P22.348	30,5 x 11	3,0	1



P22339 Plato tapas / Tapas dish / Plat à tapas / Tapas Teller



REF	cm	H cm	
P22.339	13 x 15,5	4	1
P22.341	15 x 15,0	2,5	1

P22340 Plato / Plate / Assiete / Teller



REF	Ø cm	H cm	
P22.340	19,5	3	1

P22336 Plato hondo / Deep dish / Assiette creuse / Tief Teller



REF	Ø cm	H cm	
P22.336	25,5	5,5	1

P22337 Fuente oval / Oval serving dish / Plat ovale / Ovale Buffetschale



REF	cm	H cm	
P22.337	23 x 16,5	3	1
P22.338	28 x 20,0	3	1

P22342 Bandeja rectangular / Rectangular tray / Plateau rectangulaire / Rechteckiges Tablett



REF	cm	H cm	
P22.342	31,5 x 23	3	1
P22.343	33,5 x 13	3	1



STYLISH



P22333 Plato / Plate / Assiete / Teller



REF	Ø cm	H cm	
P22.333	20	2,0	1
P22.334	27	2,5	1
P22.335	31	3,0	1



CLASSIC



P22329 Bol cónico / Conical bowl / Bol conique / Konische Schüssel



REF	Ø cm	H cm	
P22.329	17	6	1
P22.330	22	8	1
P22.331	25	9	1

MELAMINA /
MELAMINE /
MÉLAMINE



P22324 Bandeja rectangular / Rectangular tray / Plateau rectangulaire / Rechteckiges Tablett

REF	cm	H cm	GN	
P22.324	32,5 x 26,5	4	1/2	1
P22.328	32,5 x 26,5	4	1/2	1



P22.324



P22.328

P22323 Bandeja rectangular / Rectangular tray / Plateau rectangulaire / Rechteckiges Tablett

REF	cm	H cm	GN	
P22.323	32,5 x 17,6	4	1/3	1
P22.327	32,5 x 17,6	4	1/3	1



P22.323



P22.327

P22322 Bandeja rectangular / Rectangular tray / Plateau rectangulaire / Rechteckiges Tablett

REF	cm	H cm	GN	
P22.322	53 x 16,5	4	2/4	1
P22.326	53 x 16,5	4	2/4	1



P22.322



P22.326

P22325 Bandeja forma hoja / Leaf plate / Plateau forme feuille / Schale Blattform

REF	cm	H cm	
P22.325	37,5 x 15	2	1





P22740 Plato tapas / Tapas dish / Plat à tapas / Tapas Teller



REF	Ø cm	H cm	
P22.740	19,0	4,0	1
P22.741	24,0	5,1	1
P22.742	28,5	6,5	1
P22.743	35,5	6,5	1

P22744 Plato tapas / Tapas dish / Plat à tapas / Tapas Teller



REF	Ø cm	H cm	
P22.744	10,5	3,5	1
P22.745	13,0	4,0	1
P22.746	15,5	4,5	1

P22750 Bandeja cuadrada / Square tray / Plateau carré / Quadratische Schale



REF	cm	H cm	
P22.750	20,5 x 20,5	3,0	1
P22.751	25,5 x 25,5	3,5	1
P22.752	29,0 x 29,0	4,0	1

P22755 Bandeja rectangular / Rectangular tray / Plateau rectangulaire / Rechteckiges Tablett



REF	cm	H cm	
P22.755	21 x 11	2,0	1
P22.756	26 x 13	3,0	1

P22760 Bandeja snacks o salsas / Snacks or sauce tray / Plateaux sauces / Schale für Snacks oder Sossen



REF	cm	H cm	
P22.760	30 x 10	3,0	1



P22700 Bol cónico / Conical bowl / Bol conique / Konische Schüssel



REF	Ø cm	H cm	
P22.700	9,5	5,5	1
P22.701	12,5	5,5	1
P22.702	15,0	6,0	1
P22.703	18,0	9,5	1
P22.704	20,5	7,5	1
P22.705	23,0	8,0	1

P22710 Plato tapas / Tapas dish / Plat à tapas / Tapas Teller



REF	Ø cm	H cm	
P22.710	10,5	3,5	1
P22.711	15,5	4,5	1
P22.712	18,0	4,5	1

P22770 Plato presentación / Serving plate / Assiette présentation / Präsentierteller-Teller



P22.772



P22.770

REF	cm	H cm	
P22.770	22,0 x 18,5	1,0	1
P22.772	44,5 x 35,0	1,5	1

P22730 Plato / Dish / Assiette / Teller



REF	Ø cm	H cm	
P22.730	16,0	2,0	1
P22.731	20,5	3,0	1
P22.732	23,0	3,0	1
P22.733	28,0	3,5	1
P22.734	30,5	4,0	1

P22724 Pala / Peel / Pelle / Schaufel



REF	cm	H cm	
P22.724	19,5	1,5	1
P22.721	24,5	1,5	1
P22.722	28,5	1,5	1

P22715 Plato tapas / Tapas dish / Plat à tapas / Tapas Teller



REF	Ø cm	H cm	
P22.715	10,5	3,5	1
P22.716	11,5	3,5	1
P22.717	13,0	4,0	1

P22735 Bandeja snacks o salsas / Snacks or sauce tray / Plateaux sauces / Schale für Snacks oder Sossen



REF	cm	H cm	
P22.735	21,5 x 8,0	3,0	1



P22824 Bol redondo / Round bowl / Bol rond / Runde Schüssel



REF	Ø cm	H cm	
P22.824	11,5	4,0	1
P22.823	14,0	5,5	1
P22.825	19,0	6,5	1

P22815 Plato oval / Oval plate / Assiette oval / Ovaler Teller



REF	Ø cm	H cm	
P22.815	22,5	3,0	1
P22.816	25,0	3,0	1
P22.817	27,5	3,5	1

P22850 Tabla presentación curvada / Curved board / Planche incurvée présentation / Servierbrett



REF	cm	H cm	
P22.850	20,0 x 14,0	2,0	1
P22.851	25,0 x 17,5	2,5	1
P22.852	30,0 x 20,0	2,5	1

P22800 Tabla presentación / Serving board / Planche de service / Servierbrett



REF	cm	H cm	
P22.800	21 x 12	2,5	1
P22.801	24 x 14	2,5	1
P22.802	27 x 18	2,5	1
P22.803	33 x 19	2,5	1



P22782 Bandeja exhibición rectangular / Oblong display tray / Plateau rectangulaire / Quadratische Präsentationsplatte



REF	cm	H cm	
P22.782	35 x 25	4,0	1

P22780 Fuente rectangular / Oblong plate / Plateau rectangulaire / Quadratische Schale



REF	cm	H cm	
P22.780	25 x 16	3,0	1

P22781 Bandeja rectangular / Rectangular tray / Plateau rectangulaire / Rechteckiges Tablett



REF	cm	H cm	
P22.781	32 x 12	2,5	1

P22783 Fuente oval / Oval serving dish / Plat ovale / Ovale Buffetschale



REF	cm	H cm	
P22.783	35 x 15	2,5	1

P22784 Bandeja forma hoja / Leaf plate / Plateau forme feuille / Schale Blattform



REF	cm	H cm	
P22.784	34,5 x 13,5	3,0	1



P22725 Plato / Dish / Assiette / Teller



REF	Ø cm	H cm	
P22.720	22,0	2,0	1
P22.725	27,0	2,0	1

P22726 Plato hondo / Deep dish / Assiette creuse / Tief Teller



REF	Ø cm	H cm	
P22.726	20,0	3,5	1

P22727 Fuente rectangular / Oblong plate / Plateau rectangulaire / Quadratische Schale



REF	cm	H cm	
P22.727	20,0 x 14,5	4,5	1
P22.728	23,0 x 17,5	4,5	1
P22.729	27,0 x 20,0	4,5	1

P22758 Bol redondo / Round bowl / Bol rond / Runde Schüssel



REF	Ø cm	H cm	
P22.758	12,5	7,0	1

P22759 Vaso / Glass / Verre / Becher



NUEVO MODELO
NEW MODEL
NOUVEAU MODÈLE
NEUES MODELL



REF	Ø cm	H cm	
P22.759	8,0	9,5	1



P22830 Plato presentación / Serving plate /
Assiette présentation / Präsentierteller-Teller



Amarillo / Yellow /
Jaune / Gelb

REF	Ø cm	H cm	
P22.830	22	2,5	1
P22.833	28	2,5	1

P22834 Plato presentación / Serving plate /
Assiette présentation / Präsentierteller-Teller



Gris / Grey /
Gris / Grau

REF	Ø cm	H cm	
P22.834	22	2,5	1
P22.835	28	2,5	1

P22838 Plato presentación / Serving plate /
Assiette présentation / Präsentierteller-Teller



Naranja / Orange

REF	Ø cm	H cm	
P22.838	22	2,5	1
P22.839	28	2,5	1

P22844 Plato presentación / Serving plate /
Assiette présentation / Präsentierteller-Teller



Rojo / Red /
Rouge / Rot

REF	Ø cm	H cm	
P22.844	22	2,5	1
P22.845	28	2,5	1



P2290 Plato / Dish / Assiette / Platte



REF	Ø mm	H mm	
P22.901	195	28	12
P22.902	280	29	12

P2297 Bol para noodels / Noodles bowl /
Bol pour nouilles / Nudelschüssel



REF	Ø mm	H mm	
P22.971	173	76	12
P22.972	250	87	6

P2291 Bol / Bowl / Bol / Schüssel



REF	Ø mm	H mm	
P22.911	101	40	12
P22.912	115	58	12

P2296 Bol para salsas / Sauce bowl /
Bol pour sauces / Schüssel für Sossen



REF	Ø mm	H mm	
P22.960	115	55	20

P2295 Plato para bol / Dish for bowl /
Assiette pour bol / Unterteller für Schüssel



REF	mm	H mm	
P22.950	159 x 127	23	12

P2294 Bandeja rectangular / Rectangular Tray /
Plateau rectangulaire / Rechteckiges Tablett



REF	mm	H mm	
P22.940	234 x 147	25	12



P22354 Fuente / Plate / Plateau / Schale

REF	cm	H cm	
P22.354	25 x 23,5	3,0	1
P22.355	40 x 38,5	6,5	1



P22.354



P22.355

P22356 Fuente / Plate / Plateau / Schale

REF	cm	H cm	
P22.356	35 x 26,5	3,5	1
P22.357	46 x 35,0	5,0	1



P22358 Fuente / Plate / Plateau / Schale

REF	cm	H cm	
P22.358	28,5 x 27,5	7,0	1





P22349 Bandeja rectangular / Rectangular tray / Plateau rectangulaire / Rechteckiges Tablett

REF	cm	H cm	
P22.349	25 x 18,0	3,5	1
P22.350	30 x 21,5	4,0	1
P22.351	35 x 25,0	4,0	1



P22352 Bol redondo / Round bowl / Bol rond / Runde Schüssel

REF	Ø cm	H cm	
P22.352	17,5	5,5	1
P22.353	24,0	8,0	1



P22359 Bol redondo inclinado / Slanted round bowl / Bol rond incliné / Schräge runde Schale

REF	cm	H cm	
P22.359	35,5 x 32	14,5	1
P22.360	46 x 40,5	18,5	1





P2297 Bol redondo / Round bowl / Bol rond / Runde Schüssel



P. 451



REF	Ø mm	H mm	
P22.973	250	110	1
P22.974	280	120	1
P22.975	350	150	1

P22170 Bandeja forma hoja / Leaf plate / Plateau forme feuille / Schale Blattform



REF	mm	H mm	
P22.170	505 x 240	70	3

P22169 Bol oval / Oval bowl / Bol ovale / Ovale Schüssel



REF	mm	H mm	
P22.169	290 x 165	150	6

P2217 Bol torneado / Spin round bowl / Bol tourné / Gedrehte Schüssel



REF	Ø mm	H mm	
P22.171	205	95	3
P22.172	245	105	3
P22.173	280	120	3



P22037 Fuente rectangular alta /
High oblong plate /
Plateau rectanglar haut /
Hohe rechteckige Schale

P22038 Fuente rectangular alta /
High oblong plate /
Plateau rectanglar haut /
Hohe rechteckige Schale



REF	mm	H mm	
P22.037	500 x 200	50	3

REF	mm	H mm	
P22.038	350 x 250	50	3

P22164 Fuente rectangular / Oblong serving dish /
Ravier / Quadratische Schale

P22103 Bandeja 5 compartimentos /
5 - Compartment bowl /
Bol 5 compartiments /
Schale 5 Unterteilungen



IDEA!

Espacio central ideal para salsas y dippear.
Central space ideal for sauces and dips.
Espace central idéal pour sauces et tartiner.
Das perfekte Mittelstück für Sossen und Dips.

REF	mm	H mm	
P22.164	250 x 150	70	3
P22.165	350 x 250	70	3
P22.166	450 x 300	70	2

REF	Ø mm	H mm	
P22.103	380	65	3

P22501 Fuente oval / Oval serving dish /
Plat ovale / Ovale Buffetschale



REF	mm	H mm	
P22.501	325 x 200	40	1
P22.502	435 x 265	40	1

P2210 Bol redondo / Round bowl /
Bol rond / Runde Schüssel



REF	Ø mm	H mm	
P22.100	160	90	6
P22.101	260	100	6
P22.102	360	130	3

P2222 Expositor bambú con 3 bols /
Bamboo displayer with 3 bowls /
Présentoir bambou avec 3 bols /
Buffetständer Bambus mit 3 Schalen



REF	L mm	Ø mm	H mm	Lts	
P22.220	290	110	35	0,20	6
P22.221	400	130	60	0,50	6
P22.222	495	160	85	1,10	6

P2216 Bol cónico / Conical bowl /
Bol conique / Konische Schüssel



REF	Ø mm	H mm	
P22.167	130	85	6
P22.168	160	108	6

P22003 Bandeja exhibición cuadrada /
Squared display plate /
Plateau carré présentation /
Quadratische Präsentationsplatte



REF	mm	H mm	
P22.0031	310	40	3
P22.003	350	40	3
P22.0033	420	50	3

P22177 Bandeja redonda / Round plate /
Plateau rond / Runder Servierteller



REF	Ø mm	H mm	
P22.177	350	35	3



P22002 Bandeja exhibición cuadrada /
Squared display plate /
Plateau carré présentation /
Quadratische Präsentationsplatte

P222 Bol cuadrado hondo /
Deep squared bowl /
Bol carré /
Tiefe quadratische Schüssel



REF	mm	H mm	☐
P22.0021	305	35	3
P22.002	355	40	3
P22.0023	405	45	3

REF	mm	H mm	☐
P22.211	70 x 70	42	24
P22.200	90 x 90	55	12
P22.201	130 x 130	70	6
P22.202*	180 x 180	85	6
P22.203	240 x 240	100	3
P22.204	300 x 300	115	3

P2220 Bol cuadrado hondo dos colores / Two tones deep squared bowl /
Bol carré deux couleurs / Zweifarbige tiefe quadratische Schüssel

REF	mm	H mm	ROJO / RED / ROUGE / ROT	AZUL / BLUE / BLEU / BLAU	AMARILLO / YELLOW / JAUNE / GELB	VERDE / GREEN / VERT / GRÜN	NEGRO / BLACK / NOIR / SCHWARZ	☐
P22.200	90 x 90	55	R	A	AM	V	N	12
P22.202	180 x 180*	85	R	A	AM	V	N	6
P22.203	240 x 240	100	R	A	AM	V	N	3



*Encaja en expositores CUBIC.
Fits in CUBIC display.
Adaptable aux présentoirs CUBIC.
Anpassbar an dem CUBIC Buffetaussteller

Ver/See/Voir/ Siehe seite/
P. 394

REF + Código color
REF + Color code
REF + Code couleur
REF + Farbcode



P2200 Fuente cuadrada / Squared tray /
Plateau carré / Quadratische Schale



REF	A mm	H mm	
P22.001	335	55	3
P22.000	373	28	3

P2201 Fuente rectangular / Oblong plate /
Plateau rectangulaire / Quadratische Schale

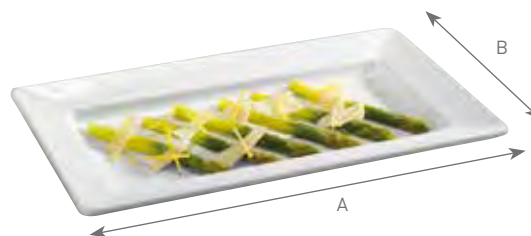

REF	A x B mm	H mm	
P22.012	358 x 205	38	3
P22.013	443 x 221	44	3
P22.014	495 x 272	56	3
P22.015	557 x 322	52	3
P22.016	710 x 405	53	3

P2215 Bandeja gastronorm / Gastronorm tray /
Plateau gastronorme / Gastronormplatte



REF	mm	H mm	
P22.150	530 x 325	20	3
P22.151	325 x 265	20	6

P22163 Fuente oval / Oval serving dish /
Plat ovale / Ovale Buffetschale



REF	mm	H mm	
P22.163	715 x 285	40	3

P22099 Plato - bol / Bowl - plate /
Plat - bol / Teller - Schüssel



REF	Ø mm	H mm	
P22.099	380	90	6

P22004 Bol cuadrado / Deep squared bowl /
Bol carré / Quadratische Schüssel



REF	mm	H mm	
P22.004	250 x 250	88	3
P22.005	375 x 375	90	3

MELAMINA /
MELAMINE /
MÉLAMINE



P22023 Fuente oval honda / Oval plate /
Plateau ovale / Ovale tiefe Buffetschale



REF	mm	H mm	
P22.023	500 x 360	67	3

P22022 Fuente redonda / Round bowl /
Bol rond / Runde Buffetschüssel



REF	Ø mm	H mm	
P22.022	360	70	3

P22019 Bol redondo / Round bowl /
Bol rond / Runde Schüssel



REF	Ø mm	H mm	
P22.019	200	90	3
P22.020	280	125	3
P22.021	380	170	3

P22174 Bol redondo inclinado / Slanted round bowl /
Bol rond incliné / Schräge runde Schale



REF	mm	H mm	Lts	
P22.174	212 x 208	104	0,60	6
P22.175	300 x 291	137	1,60	3
P22.176	360 x 349	163	2,85	3

P22090 Plato redondo de presentación /
Round plate presentation /
Plateau rond présentation /
Runder Servierteller



REF	Ø mm	H mm	
P22.090	310	20	4

P2208 Bandeja exhibición rectangular /
Oblong display tray /
Plateau rectangulaire /
Quadratische Präsentationsplatte



REF	mm	H mm	
P22.085	390 x 150	15	6
P22.086	500 x 180	18	6



P2211 Plato / Round dish /
Assiette plate / Teller



REF	Ø mm	H mm	
P22.111	160	23	12
P22.112	200	23	12
P22.113	230	23	6
P22.114	265	23	6

P22115 Plato sopa / Soup plate /
Assiette à soupe / Suppenteller



REF	Ø mm	H mm	
P22.115	240	37	6

P22116 Bol grande / Big salad bowl /
Saladier grand / Grosse Schüssel



REF	Ø mm	H mm	
P22.116	190	50	6

P22182 Plato oval / Oval dish /
Assiette ovale / Ovaler Teller



REF	mm	H mm	
P22.182	243 x 182	21	6
P22.183	305 x 232	25	6
P22.184	342 x 268	27	6

P2225 Bol cereales encastrable / Stackable bowl /
Bol empilable / Stapelbare Müslischüssel



REF	Ø mm	H mm	
P22.250	120	45	12
P22.251	140	55	12

P22117 Bol pequeño / Small salad bowl /
Saladier petit / Kleine Schüssel



REF	Ø mm	H mm	
P22.117	140	60	12

P22178 Taza / Cup / Tasse / Tasse
Plato / Plate / Assiette / Unterteller



	REF	Size	Ø mm	H mm	Lts	
TAZA / CUP / TASSE / TASSE	P22.178	S	70	48	0,10	12
	P22.180	L	98	65	0,25	12
PLATO / PLATE / ASSIETTE / UNTERTELLER	P22.179	S	103			12
	P22.181	L	144			12

P22118 Taza apilable / Stackable mug /
Tasse empilable / Stapelbare Tasse



REF	Ø mm	H mm	Lts	
P22.118	75	100	0,30	6

P22033 Cuchara perforada / Slotted spoon /
Cuillère ajourée / Gelochter Löffel



REF	L mm	
P22.033	300	24

P22034 Cacillo / Soup ladle /
Louche / Schöpflöffel



REF	L mm	Lts	
P22.034	170	0,08	24

VER PRODUCTOS EN / SEE PRODUCTS ON / VOIR PRODUITS EN PAGE / SIEHE PRODUKTE IN

Manteles individuales /
Place mats /
Sets de table /
Individuelle Platzmatten



P. 500



P23990 Bandeja presentación / Display tray / Plateau présentation / Präsentationsschale

1/1 1/2 1/3 2/4

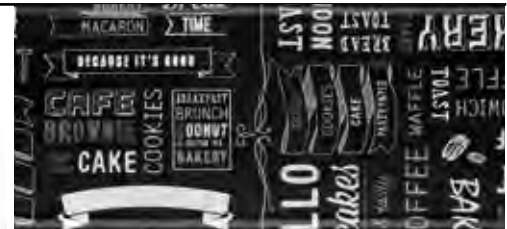

REF	Mod	L mm	H cm	
P23.990	1/1	530 x 325	1,8	12
P23.991	1/2	325 x 265	1,8	24
P23.992	1/3	325 x 176	1,8	36
P23.993	2/4	530 x 162	1,8	24

P22775 Bandeja repostería / Confectionery tray / Plateau à pâtisserie / Gebäckschale



P22.775



P22.779

REF	Mod	cm	H cm	
P22.775		36,5 x 29,5	2	1
P22.776		36,5 x 29,5	2	1
P22.777		36,5 x 29,5	2	1
P22.778		36,5 x 29,5	2	1
P22.779		36,5 x 29,5	2	1

VER PRODUCTOS EN / SEE PRODUCTS ON / VOIR PRODUITS EN PAGE / SIEHE PRODUKTE IN

Tapas GN transparentes presentación /
Clear GN lids for presentation /
Couvercles GN transparents de présentation /
Transparente GN-Präsentationdeckel



P. 455



ESPAÑOL

Exclusiva gama de tablas de melamina donde la apariencia y el tacto hacen que la imitación de roble viejo sea prácticamente perfecta. Para una presentación elegante.

ENGLISH

Exclusive range of melamine boards similar to oak thanks to its appearance and its touch. Ideal for a nice presentation.

FRANÇAIS

Gamme exclusive de tablettes de mélamine dont l'apparence et le toucher ressemblent très fortement au bois de chêne. Idéal pour une présentation élégante.

DEUTSCH

Exclusive serie von melaminplatten, welche durch ihre äussere erscheinung und der oberfläche der rustikalen eiche praktisch perfekt ähnelt. Für eine elegante präsentation.

P22127 Soporte presentación / Display plate / Présentoir / Präsentationsplatte



REF	Ø mm	H cm	
P22.127	230	1,5	1
P22.128	280	1,5	1
P22.129	325	1,5	1

P2265 Pala horno roble / Oven oak peel / Pelle four chêne / Backofenschaufel Eiche



REF	mm	
P22.650	Ø 300	6
P22.651	530 x 200	6
P22.652	610 x 200	6

P2260 Soporte presentación roble / Oak display plate / Présentoir chêne / Präsentationsständer Eiche



Con pies antideslizantes
With non-slip feet
Avec pieds antidérapants
Mit Antirutschfüßen

REF	MOD.	mm	
P22.600	1/1	530 x 325	3
P22.601	1/2	325 x 265	6
P22.602	1/3	325 x 176	6
P22.603	1/4	265 x 162	6
P22.604	2/4	530 x 165	6
P22.605		500 x 250	3
P22.606		250 x 150	6

P2262 Bandeja presentación roble / Oak serving tray / Plateau présentation bois / Eichentablett



REF	mm	H mm	
P22.620	300 x 150	18	12
P22.621	300 x 200	18	12
P22.622	400 x 300	18	6

P2261 Soporte presentación / Display plate / Présentoir / Präsentationsplatte

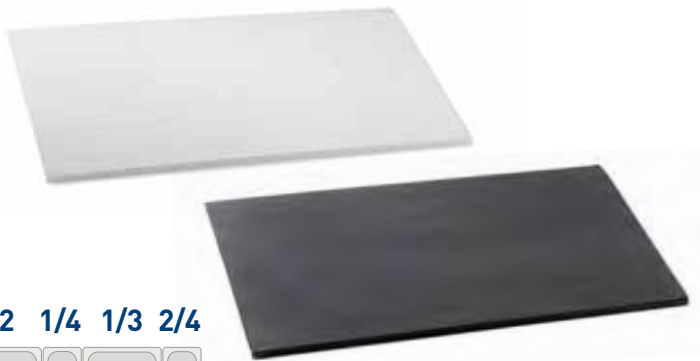

REF	MOD.	mm	BLANCO / WHITE / BLANC / WEISS	NEGRO / BLACK / NOIR / SCHWARZ	
P22.610	1/1	530 x 325	B	N	3
P22.611	1/2	325 x 265	B	N	4
P22.612	1/3	325 x 176	B	N	6
P22.613	1/4	265 x 162	B	N	6
P22.614	2/4	530 x 165	B	N	6
P22.615		500 x 250	B	N	3
P22.616		250 x 150	B	N	6

Con pies antideslizantes
With non-slip feet
Avec pieds antidérapants
Mit Antirutschfüßen

REF + código color
REF + color code
REF + code couleur
REF + Farbcode

P22664 Soporte presentación madera blanca / White wood serving tray /
Plateau présentation bois blanc / Weiße Holzpräsentationstablett



REF	Mod	L mm	H cm	
P22.660	1/1	530 x 325	1,0	6
P22.661	1/2	325 x 265	1,0	24
P22.662	1/3	325 x 176	1,0	24
P22.663	1/4	265 x 162	1,0	24
P22.664	2/4	530 x 163	1,0	12

MELAMINA /
MELAMINE /
MÉLAMINE



P22690 Soporte presentación pizarra / Slate display plate / Présentoir base ardoise / Präsentationstablrett Schiefertafel

1/2 1/4 1/3



REF	Mod	L mm	H cm	
P22.690	1/2	325 x 265	1,0	24
P22.691	1/3	325 x 175	1,0	24
P22.692	1/4	265 x 160	1,0	24

P2264 Bandeja base pizarra / Slate display plate / Présentoir base ardoise / Präsentationstablrett Schiefertafel

1/2 1/4 1/3



REF	MOD.	mm	BLANCO / WHITE / BLANC / WEISS	NEGRO / BLACK / NOIR / SCHWARZ	
P22.640	1/2	325 x 265	B	N	6
P22.641	1/3	325 x 175	B	N	6
P22.642	1/4	265 x 160	B	N	6

Con pies antideslizantes REF + código color
 With non-slip feet REF + color code
 Avec pieds antidérapants REF + code couleur
 Mit Antirutschfüßen REF + Farbcode

P22161 Soporte presentación Pizarra - granito / Slate - granite Display plate / Présentoir Ardoise - granite / Präsentationsplatte Schiefer - Granit

1/1 1/2

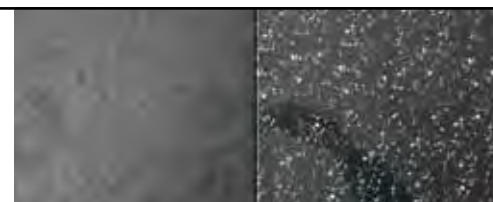

REF	MOD.	mm	H mm	
P22.161	1/1	530 x 325	7,0	3
P22.162	1/2	325 x 265	7,0	3

Reversible: 1 cara pizarra - 1 cara granito
 Reversible: 1 slate side - 1 granite side
 Réversible: 1 face ardoise - 1 face granite
 Reversibel: 1 Seite Schiefer - 1 Seite Granit

P22017 Soporte "mármol" / "Marble" display plate / Plateau "Marbre" / "Marmor" Platte



REF	mm	H mm	
P22.017	590 x 240	24	3

P22144 / P22145 Soporte presentación doble cara pizarra - bambú / Double face slate - bamboo display plate / Présentoir double face bambou - ardoise / Zweiseitige Präsentationsplatte Schiefer - Bambus

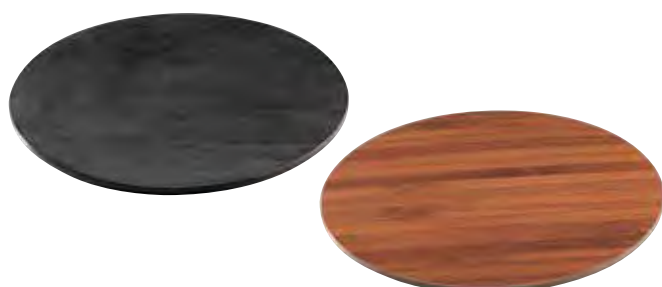

REF	Ø mm	H mm	
P22.144	330	10	3
P22.145	430	10	3

P22124 Soporte presentación / Display plate / Présentoir / Präsentationsplatte

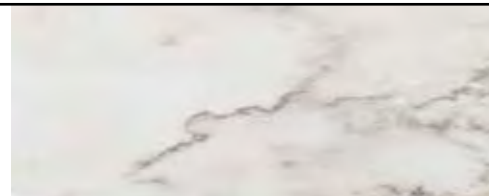

REF	Ø mm	H cm	
P22.124	230	1,5	1
P22.125	280	1,5	1
P22.126	325	1,5	1

P22695 Soporte presentación mármol / Marble display plate / Présentoir base marbre / Präsentationstablett Marmor

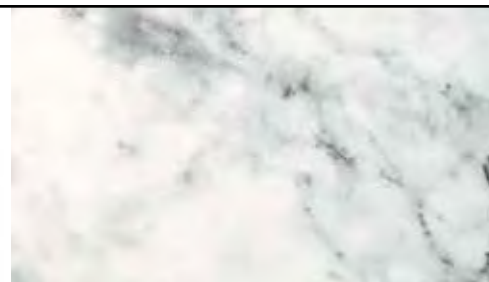

BASE*

REF	Mod	L mm	H cm	
P22.695	1/1	530 x 325	20	9
P22.696	1/2	325 x 265	20	12
P22.697	1/3	325 x 176	20	24
P22.698*		150 x 150	95	48

GN 1/1

530 x 325 mm



AMARILLO / YELLOW / JAUNE / GELB

REF	H mm	
P22.866	20	6
P22.867	40	3
P22.868	65	2

NARANJA / ORANGE

REF	H mm	
P22.863	20	6
P22.864	40	3
P22.865	65	2

ROJO / RED / ROUGE / ROT

REF	H mm	
P22.869	20	6
P22.870	40	3
P22.871	65	2

GRIS / GREY / GRIS / GRAU

REF	H mm	
P22.860	20	6
P22.861	40	3
P22.862	65	2

GN 1/2

325 x 265 mm



AMARILLO / YELLOW / JAUNE / GELB

REF	H mm	
P22.878	20	6
P22.879	40	3
P22.880	65	2

NARANJA / ORANGE

REF	H mm	
P22.875	20	6
P22.876	40	3
P22.877	65	2

ROJO / RED / ROUGE / ROT

REF	H mm	
P22.881	20	6
P22.882	40	3
P22.883	65	2

GRIS / GREY / GRIS / GRAU

REF	H mm	
P22.872	20	6
P22.873	40	3
P22.874	65	2

VER PRODUCTOS EN / SEE PRODUCTS ON / VOIR PRODUITS EN PAGE / SIEHE PRODUKTE IN

**BUF
FET**



P. 449

GN 1/1

530 x 325 mm



REF	H mm	
P22.051	20	6
P22.053	40	3
P22.009	65	2

GN 2/3

353 x 325 mm



REF	H mm	
P22.047	65	3

GN 1/2

325 x 265 mm

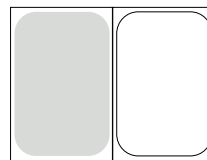

REF	H mm	
P22.039	20	6
P22.041	40	3
P22.010	65	3
P22.084	100	3

GN 2/4

530 x 162 mm



REF	H mm	
P22.049	65	3

GN 1/3

325 x 175 mm

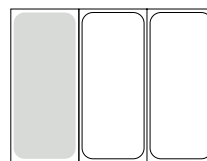

REF	H mm	
P22.011	65	3
P22.080	100	3

GN 1/4

265 x 162 mm



REF	H mm	
P22.043	65	3

GN 1/6

176 x 162 mm

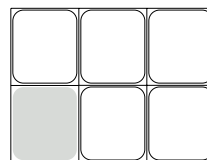

REF	H mm	
P22.045	65	6
P22.082	100	6

11.1 MELAMINA / MELAMINE /
MÉLAMINE / MELAMIN



GN SLIM CUBETA LIGERA / SLIM PAN /
BAC LÉGER / LEICHTE BEHÄLTER



Ideal buffets fríos.
Ideal for cold buffets.
Idéal pour buffets froids
Ideal für kalte Buffets

Apilable / Stackable /
Empilable / Stapelbar

1/1 1/2 1/4 1/3 2/4 1/6

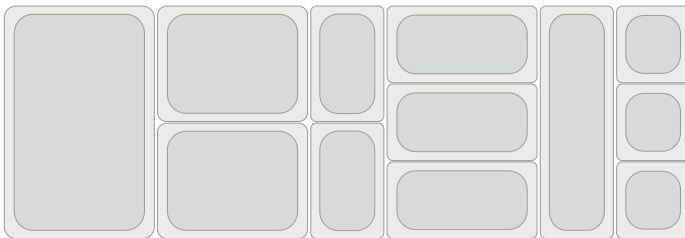

BASE

ESTRUCTURA ROBUSTA /
STRONG STRUCTURE /
STRUCTURE ROBUSTE /
ROBUSTE STRUKTUR



Estilizada /
Stylized /
Stylisée /
Stilisiert



CLASSIC
Cubeta tradicional.
Current pan.
Bac traditionnel.
Traditioneller GN-Behälter.

GN 1/1 530 x 325 mm



REF	H mm	
P23.030	20	12
P23.031	65	6
P23.032	100	6

GN 1/2 325 x 265 mm



REF	H mm	
P23.033	20	24
P23.034	65	12
P23.035	100	12

GN 2/4 530 x 162 mm



REF	H mm	
P23.044	20	12
P23.045	65	12
P23.046	100	12

GN 1/3 325 x 176 mm



REF	H mm	
P23.036	20	24
P23.037	65	24
P23.038	100	12

GN 1/4 265 x 162 mm



REF	H mm	
P23.039	20	48
P23.040	65	24
P23.041	100	12

GN 1/6 176 x 162 mm



REF	H mm	
P23.042	65	24
P23.043	100	24

GN 1/1

530 x 325 mm



REF	H mm	
P22.052	20	6
P22.054	40	3
P22.006	65	2

GN 2/3

353 x 325 mm

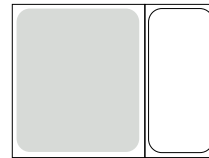

REF	H mm	
P22.048	65	3

GN 1/2

325 x 265 mm

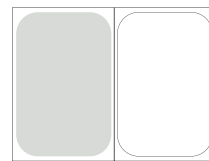

REF	H mm	
P22.040	20	6
P22.042	40	3
P22.007	65	3
P22.083	100	3

GN 2/4

530 x 162 mm

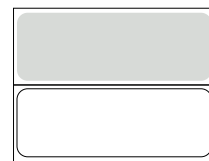

REF	H mm	
P22.087	20	6
P22.050	65	3

GN 1/3

325 x 175 mm

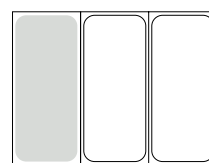

REF	H mm	
P22.094	20	6
P22.008	65	3
P22.079	100	3

GN 1/4

265 x 162 mm



REF	H mm	
P22.044	65	3

GN 1/6

176 x 162 mm

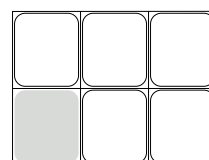

REF	H mm	
P22.046	65	6
P22.081	100	6

P22154 Expositor buffet para cubetas GN 1/1 /
1/1 Gastronorm buffet display /
Présentoir buffet pour bacs GN 1/1 /
Buffetständer für GN 1/1 Behälter



Cubetas no incluidas /
Containers not included /
Bacs non inclus /
Behälter nicht inklusive

REF	TIPO/TYPE	mm	H mm	
P22.154	1/1	565 x 525	325	6

P22155 Expositor buffet para cubetas GN 1/2 /
1/2 Gastronorm buffet display /
Présentoir buffet pour bacs GN 1/2 /
Buffetständer für GN 1/2 Behälter



Cubetas no incluidas /
Containers not included /
Bacs non inclus /
Behälter nicht inklusive

REF	TIPO/TYPE	mm	H mm	
P22.155	1/2	360 x 525	325	6

P22156 Expositor buffet para cubetas GN 1/3 /
1/3 Gastronorm buffet display /
Présentoir buffet pour bacs GN 1/3 /
Buffetständer für GN 1/3 Behälter



Cubetas no incluidas /
Containers not included /
Bacs non inclus /
Behälter nicht inklusive

REF	TIPO/TYPE	mm	H mm	
P22.156	1/3	360 x 525	325	6

P22157 Expositor buffet para cubetas GN 1/6 /
1/6 Gastronorm buffet display /
Présentoir buffet pour bacs GN 1/6 /
Buffetständer für GN 1/6 Behälter



Cubetas no incluidas /
Containers not included /
Bacs non inclus /
Behälter nicht inklusive

REF	TIPO/TYPE	mm	H mm	
P22.157	1/6	215 x 525	325	6

P22158 Expositor 4 vasijas /
4 Crock system stand /
Présentoir 4 cruches /
Buffetständer 4 Gefässe



P22.160
Vasijas no incluidas /
Crockes not included /
Cruches pas incluses /
Gefässe nicht inklusive

REF	mm	H mm	
P22.158	190 x 525	325	6

P22160 Vasija 1l / 1l crock /
Cruche 1l / Gefäss 1l



REF	Ø mm	H mm	
P22.160	130	105	6



P22108 Platillo cuadrado / Squared bowl / Bol carré / Quadratisches Tellerchen



REF	mm	H mm	Lts	
P22.108	100 x 100	33	0,10	24
P22.109	125 x 125	35	0,18	24

P22088 Platillo para huevo / Egg cup / Coquetier / Eierbecher



REF	mm	H mm	
P22.088	115 x 115	20	24

P22104 Mini bandeja presentación / Mini square plate / Plateau miniature / Mini Buffettblett

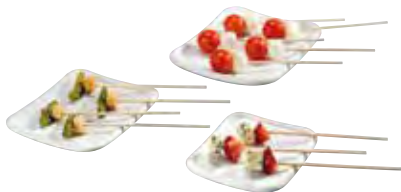

REF	mm	H mm	
P22.104	125 x 105	20	24
P22.105	140 x 130	20	24
P22.106	170 x 140	25	24

P867 Recipiente para salsas / Ramekin / Ramequin / Sossengefäß



REF	ml	Ø mm	H mm	
P867.030	30	50	23	12
P867.060	60	60	30	12
P867.090	90	70	35	12
P867.120	120	75	40	12

P22107 Platillo concha / Shell saucer / Soucoupe coquille / Muscheltellerchen



REF	mm	H mm	
P22.107	155 x 115	20	24

P22110 Cuchara degustación / Party spoon / Cuillère amuse bouche / Verkostungslöffel



REF	mm	H mm	
P22.110	145 x 45	50	60

P22890 Fuente rectangular / Small tray / Ravier rectangulaire / Rechteckiges Buffettblett



REF	mm	H mm	
P22.890	130 x 90	20	24



Apilable / Stackable / Empilable / Stapelbar



P23840

Cacerola oval / Oval casserole /
Casserole ovale / Ovale Kasserolle



REF	cm	L cm	H cm	
P23.840	12 x 8	15,5	3,5	96
P23.841	21 x 14	26,5	3,5	96

P23836

Mini cacerola redonda / Mini round casserole /
Mini cocotte ronde / Runder Minikasserolle



REF	Ø cm	L cm	H cm	
P23.835	11,5	15	3,5	96
P23.836	14,5	19	3,5	96

P23830

Mini parrilla con asas / Mini hot plate with handles /
Mini grill avec poignées / Mini Bratplatte mit Griffen



REF	cm	L cm	H cm	
P23.830	26 x 16	32	2,0	96

P23824

Mini sartén cuadrada / Mini squared fry pan /
Mini poêle carrée / Quadratische Minibratpfanne



REF	cm	L cm	H cm	
P23.824	12,5 x 10,5	16	2,0	96

P23825

Mini sartén redonda / Mini round fry pan /
Mini poêle ronde / Runder Minibratpfanne



REF	Ø cm	L cm	H cm	
P23.825	11	16	3,0	96

P23800

Mini cacerola con tapa / Mini round casserole with lid /
Mini cocotte avec couvercle / Minikasserolle mit Deckel



P23.810

P23.800

REF	Ø cm	H cm	L cm	
P23.800	10	6,5	0,25	1
P23.810	14	8,0	0,75	1

MELAMINA /
MELAMINE /
MÉLAMINE

P23842 Mini cacerola / Mini casserole /
Mini cocotte / Minikasserolle



REF	Ø cm	H cm	
P23.842	9	4,5	1

P23843 Mini cacerola oval / Mini oval casserole /
Mini cocotte ovale / Mini Ovale Kasserolle



REF	cm	H cm	
P23.843	18 x 13	4,0	1

P23844 Mini cacerola rectangular /
Mini rectangular casserole /
Mini casserole rectangulaire /
Mini Rechteckiges Kasserolle



REF	cm	H cm	
P23.844	19,5 x 10	5,0	1

P23845 Mini sartén redonda /
Mini round fry pan /
Mini poêle ronde /
Runder Minibratpfanne



REF	Ø cm	L cm	H cm	
P23.845	21,5	30,5	3,0	1

P22120 Bandeja snacks o salsas /
Snacks or sauce tray /
Plateaux sauces /
Schale für Snacks oder Sossen



REF	cm	H cm	
P22.120	17,5 x 8,5	3,5	1

P2293 Bandeja snacks o salsas /
Snacks or sauce tray /
Plateaux sauces /
Schale für Snacks oder Sossen



REF	mm	H mm	
P22.920	190 x 80	30	12
P22.930	92 x 69	31	24

P22035 Cenicero cuadrado. Negro /
Squared ashtray. Black /
Cendrier carré. Noir /
Quadratische Aschenbecher. Schwarz



REF	cm	H cm	
P22.035	9 x 9	3,0	1

P22036 Cenicero redondo. Negro /
Round ashtray. Black /
Cendrier rond. Noir /
Runder Aschenbecher. Schwarz



REF	Ø cm	H cm	
P22.036	10	4,5	1

P22030 Cenicero redondo con tapa. Negro /
Windproof ashtray round with lid. Black /
Cendrier pour l'extérieur avec couvercle. Noir /
Runder Aschenbecher mit Deckel. Schwarz



REF	Ø cm	H cm	
P22.030	14,5	6,0	6

P22031 Cenicero redondo. Negro /
Round dinner ashtray. Black /
Cendrier rond. Noir /
Runder Aschenbecher. Schwarz



REF	Ø cm	H cm	
P22.031	10	5,0	12

P22185 Cenicero cónico melamina. Negro / Conical melamine ashtray. Black /
Cendrier conique. Noir / Konischer Aschenbecher. Schwarz



REF	Ø cm	H cm	
P22.185	10	2,7	24



**BUFFET Y ACCESORIOS /
BUFFET & ACCESSORIES /
BUFFET ET ACCESSOIRES /
BUFFET UND ZUBEHÖR**

12.1	COOL - LINE COLLECTION	406
12.2	SUPER SHAPES CUBETAS PRESENTACIÓN BUFFET / BUFFET PRESENTATION STEAM TABLE PANS / BACS PRÉSENTATION BUFFET / BUFFET PRÄSENTATION DAMPFBEHEIZTE WANNEN	412
12.3	MIRAMAR® COOKWARE BATERÍA DE COCINA PARA PRESENTACIÓN / DISPLAY COOKWARE / BATTERIE DE CUISINE-PRÉSENTATION / PRÄSENTATIONS-KOCHGESCHIRR	416
12.4	CUBIC	422
12.5	PRESENTACIÓN Y EXPOSITORES / DISPLAY STANDS & DISPLAY BASKETS / PRÉSENTOIRS ET PRÉSENTOIRS CORBEILLES / PRÄSENTATIONSSTÄNDER DISPLAY-KÖRBE	448
12.6	CHAFINGS Y DISPENSADORES / CHAFERS & DISPENSERS / CHAFERS ET DISTRIBUTEURS / CHAFERS & SPENDER	456
12.7	ESTACIONES CONTORNEADAS PARA BANQUETES / CONTOURED BUFFET STATIONS / STATIONS POUR BUFFET ARRONDIES / GEWELLTE BÜFFETSTATIONEN	465
12.8	BOLS DOBLE PARED / DOUBLE WALL BOWLS / BOLS DOUBLE PAROI / DOPPELWANDIGE SCHALEN	466
12.9	BANDEJAS DE SERVICIO / SERVING TRAYS / PLATEAUX / SERVIERTABLETTS	470
12.10	UTENSILIOS DE SERVICIO / SERVING TOOLS / USTENSILES DE SERVICE BUFFET / SERVIERBESTECK	472
12.11	SEÑALIZACIÓN / SIGNS / SIGNALISATION / MARKIERUNG	482

COOL • LINE COLLECTION

COOL • LINE
COLORS



Ref. color /
Ref. colour /
Ref. couleur couvercle /
Art.Nr. Farben

PATENTED **EXCLUSIVE**

P1106F3 Cubeta GN antiadherente con fondo difusor / Non-stick sandwich bottom GN container / Bac GN anti-adhésive avec fond thermo-diffuseur / GN Behälter Antihaft mit Sandwichboden



**INOX - ST/STEEL
EDELSTAHL
18/10**

IDEA!

Ideal para presentación buffet.
Ideal for buffet presentations.
Idéal pour présentation buffet.
Ideal für buffet präsentation.

REF	TIPO TYPE	H mm	Lts	
P110.6F3A	1/1	65	8,30	1
P110.6F3N	1/1	65	8,30	1
P110.6F3R	1/1	65	8,30	1
P110.6F3G	1/1	65	8,30	1
P120.6F3A	1/2	65	4,10	1
P120.6F3N	1/2	65	4,10	1
P120.6F3R	1/2	65	4,10	1
P120.6F3G	1/2	65	4,10	1

P110.6F3A



P110.6F3N



P110.6F3R



P110.6F3G

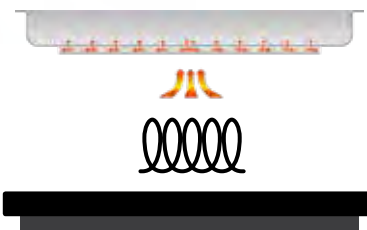

VER PRODUCTOS EN / SEE PRODUCTS ON / VOIR PRODUITS EN PAGE / SIEHE PRODUKTE IN

MELAMINA / MELAMINE /
MÉLAMINE / MELAMIN



P. 394

COOL • LINE COLLECTION

COOL • LINE
COLORS



Ref. color /
Ref. colour /
Ref. couleur couvercle /
Art.Nr. Farben

EXCLUSIVE

P4906CO Cacerola alta con tapa / Sauce pot with lid / Braisière avec couvercle / Hohe Kasserolle mit Deckel



EXCLUSIVE



REF	Ø cm	H cm	Lts	
P490.620 + COLOR	20	13,0	3,70	1
P490.624 + COLOR	24	14,0	5,80	1
P490.628 + COLOR	28	17,5	9,50	1
P490.632 + COLOR	32	19,0	14,00	1

P4907CO Cacerola baja con tapa / Casserole with lid / Faitout avec couvercle / Flache Kasserolle mit Deckel



EXCLUSIVE



REF	Ø cm	H cm	Lts	
P490.724 + COLOR	24	9,5	3,90	1
P490.728 + COLOR	28	11,0	5,80	1
P490.732 + COLOR	32	12,5	8,90	1

P4909 Paellera con tapa / Paella pan with lid / Plat à paella avec couvercle / Paellapfanne mit Deckel



EXCLUSIVE

N



REF	Ø cm	H cm	Lts	
P490.928 + COLOR	28	6,0	3,70	1
P490.932 + COLOR	32	6,0	4,70	1

P4900CO Cazo recto / Saucepan / Casserole / Gerade Stielkasserolle



EXCLUSIVE



REF	Ø cm	H cm	Lts	
P490.014 + COLOR	14	7,0	1,00	1
P490.016 + COLOR	16	7,5	1,50	1

BUFFET ACCESSORIES /
BUFFET & ACCESSORIES /
BUFFET ET ACCESSOIRES

COOL • LINE COLLECTION

COOL • LINE
COLORS

P4902CO Sartén antiadherente / Non-stick fry pan / Poêle anti-adhésive / Bratpfanne Antihaft



REF	Ø cm	H cm	
P490.220 + COLOR	20	3,8	1
P490.224 + COLOR	24	4,6	1
P490.228 + COLOR	28	5,5	1

Fondo sandwich / Sandwich bottom /
Fond sandwich / Sandwichboden.

ANTIADHERENTE / NON-STICK COATING /
ANTI-ADHÉSIF / ANTIHAFTBESCHICHTUNG



VER PRODUCTOS EN / SEE PRODUCTS ON / VOIR PRODUITS EN PAGE / SIEHE PRODUKTE IN

COOL • LINE

CACEROLA ALTA CON TAPA /
SAUCE POT WITH LID /
BRAISIÈRE AVEC COUVERCLE /
HOHE KASSEROLLE MIT DECKEL

P. 32



VER PRODUCTOS EN / SEE PRODUCTS ON /
VOIR PRODUITS EN PAGE / SIEHE PRODUKTE IN

BOL COLORES CUADRADO DOBLE PARED /
SQUARE COLORED DOUBLE WALL BOWLS /
BOLS CARRÉS DE SERVICE À DOUBLE PAROI
ISOTHERMES EN COULEURS /
RUNDE SERVIERSCHALEN, DOPPELWANDIG
ISOLIERT UND FARBIG

P. 469



VER PRODUCTOS EN / SEE PRODUCTS ON /
VOIR PRODUITS EN PAGE / SIEHE PRODUKTE IN

LECHERA /
CREAMER /
CREMIÈRE /
MILCHKANNE

P. 524



COOL • LINE COLLECTION

COOL • LINE
COLORS

P8945 Conjunto alto baño maría color / Colored High Bain marie Set / Ensemble bain marie haut couleur / Wasserbad-set farbe



EXCLUSIVE



REF	Ø cm	H cm	A B		☐
			L	L Max.	
P894.524+color	A 20	10	3,10	-	1
	B 24	14	-	1,50	
P894.528+color	A 24	12	5,40	-	1
	B 28	16	-	2,75	
P894.532+color	A 28	14	8,60	-	1
	B 32	19	-	3,50	

Color / Colour /
Couleur / Farbe



P8946 Conjunto bajo baño maría color / Colored Low Bain marie Set / Ensemble bain marie bas couleur / Flaches wasserbad-set farbe



EXCLUSIVE



REF	Ø cm	H cm	A B		☐
			L	L Max.	
P894.632+color	A 28	6	3,70	-	1
	B 32	12,5	-	5,00	

Color / Colour /
Couleur / Farbe

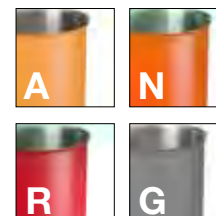

VER PRODUCTOS EN / SEE PRODUCTS ON / VOIR PRODUITS EN PAGE / SIEHE PRODUKTE IN

PLACA INDUCCIÓN MANTENEDORA DE TEMPERATURA /
BUFFET INDUCTION WARMER /
PLAQUE INDUCTION DE MAINTIEN TEMPÉRATURE /
WARMEHALTE-INDUKTIONSPLATTE



595087502
595087503

P. 289

BUFFET ACCESSORIES /
BUFFET & ACCESSORIES /
BUFFET ET ACCESSOIRES



COOL • LINE

COLLECTION

BAÑO MARÍA / BAIN MARIE / BAIN-MARIE / WASSERBAD

ESPECIAL SERVICIO BUFFET /
SPECIAL BUFFET SERVICE /
SPÉCIAL SERVICE BUFFET /
SPEZIELL FÜR BUFFETSERVICE

EXCLUSIVE



INDUCTION

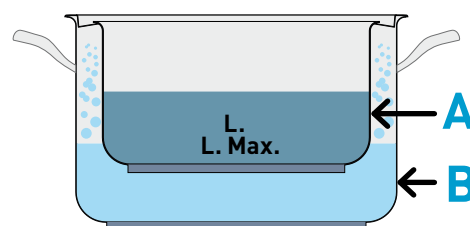
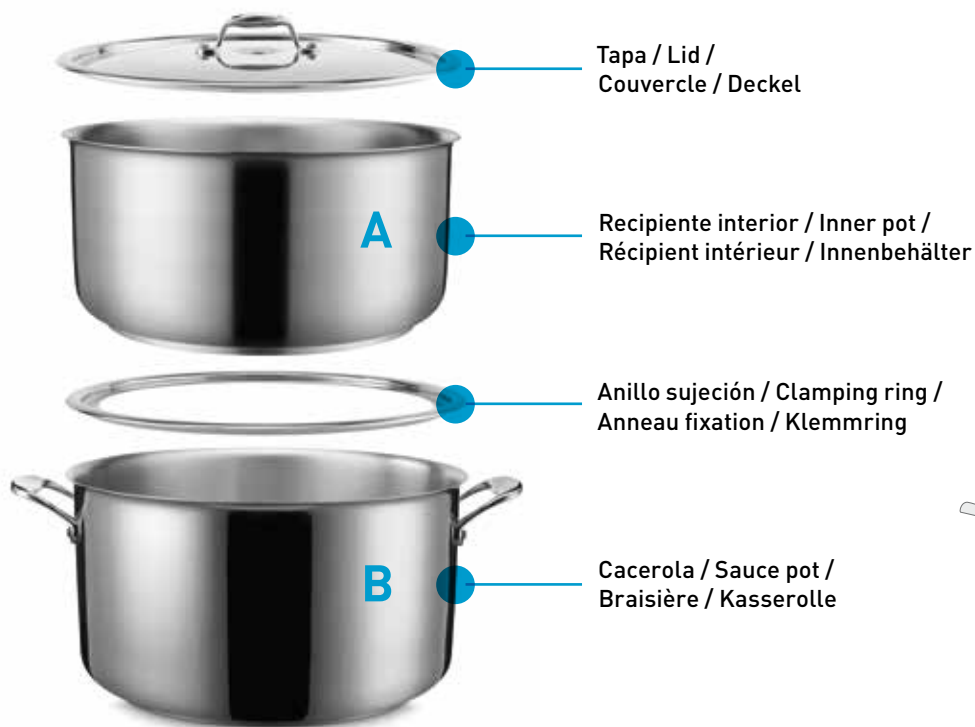

P8945 Conjunto alto baño maría / High Bain marie set / Ensemble bain marie haut / Hohes Wasserbad Set



EXCLUSIVE



REF	Ø cm	H cm	A		B		📦
			L	L Max.	L	L Max.	
P894.524	A 20	10	3,10	-	-	-	1
	B 24	14	-	1,50	-	-	
P894.528	A 24	12	5,40	-	-	-	1
	B 28	16	-	2,75	-	-	
P894.532	A 28	14	8,60	-	-	-	1
	B 32	19	-	3,50	-	-	

P8946 Conjunto bajo baño maría / Low Bain marie set / Ensemble bain marie bas / Flaches Wasserbad Set



EXCLUSIVE



REF	Ø cm	H cm	A		B		📦
			L	L Max.	L	L Max.	
P894.632	A 28	6	3,70	-	-	-	1
	B 32	12,5	-	5,0	-	-	

BUFFET ACCESSORIES /
BUFFET & ACCESSOIRES /
BUFFET ET ACCESSOIRES



SUPER SHAPES

PATENTED EXCLUSIVE

ESPAÑOL

Presentación de las comidas en chafers, líneas buffet calientes o fríos, vitrinas de presentación y más.

ENGLISH

Presentation of food in chafers, heated or refrigerated buffet lines, display cases, and more.

FRANÇAIS

Présentation des plats dans les chafers, les lignes de buffet chauffées ou réfrigérées, les présentoirs et bien plus encore.

DEUTSCH

Eine kosteneffektive methode zur eleganteren darstellung von speisen in rechauds, beheizten oder gekühlten büffets, vitrinen und mehr.

Combine con /
Mix with
Combiner avec /
Kombinieren

P. 159



SP3

Referencia Barra adaptadora / Adaptor Bar Reference /
Référence barre intermédiaire / Adapterschiene

75015

75013

2/4

1/2

1/3

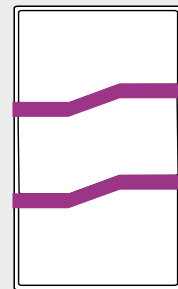
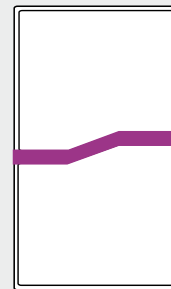
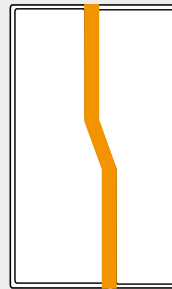

Apilable / Stackable /
Empilable / Stapelbar



3101015 Ovalada / Full Oval / Ovale / Oval, volle Größe

1/1

NSF



REF	mm	H mm	L	
3101015	530 x 325	51	3,7	6
3101020	530 x 325	65	4,6	6
3101040	530 x 325	100	7,8	6

3102015 Óvalo / Half Oval / Ovale / Oval, halbe Größe

1/2

NSF



REF	mm	H mm	L	
3102015	265 x 325	51	1,6	6
3102020	265 x 325	65	2,1	6
3102040	265 x 325	100	3,5	6

3103040 Óvalo / Third Oval / Ovale / Oval, Drittelgröße

1/3

NSF



REF	mm	H mm	L	
3103040	176 x 325	100	2,1	6

3101220 Hexágono / Full Hexagon / Hexagonal / Sechseckige

1/1

NSF



REF	mm	H mm	L	
3101220	530 x 325	65	5	6
3101240	530 x 325	100	8,8	6

3102220 Hexágono / Full Hexagon / Hexagonal / Sechseckige

1/2

NSF



REF	mm	H mm	L	
3102220	265 x 325	65	2,1	6
3102240	265 x 325	100	3,6	6

3101120 Reniforme / Full Kidney / Rein / Niere, volle Größe

1/1

NSF



REF	mm	H mm	L	
3101120	530 x 325	65	4,8	6

3102120 Reniforme / Half Kidney / Rein / Niere, halbe Größe

1/2



REF	mm	H mm	L	
3102120	265 x 325	65	2,1	6

3100020 Wild Pan larga / Long Wild Pan / Wild Pan long / Lange Wild Pan

2/4



REF	mm	H mm	L	
3100020	530 x 165	65	3,5	6
3100040	530 x 165	89	4,8	6

75015

3100220 Wild Pan corta / Short Wild Pan / Wild Pan court / Kurze Wild Pan

1/2



REF	mm	H mm	L	
3100220	265 x 325	65	3,9	6
3100240	265 x 325	100	6,1	6

75013

3100320 Wild Pan externa / Third Outer Wild Pan / Troisième Wild Pan extérieur / Wild Pan, Drittelgröße, außen

1/3



REF	mm	H mm	L	
3100320	176 x 325	65	2,5	6
3100340	176 x 325	100	3,6	6

75013

3100321 Wild Pan interna / Inner Wild Pan / Troisième Wild Pan intérieur / Wild Pan, Drittelgröße, innen

1/3



REF	mm	H mm	L	
3100321	176 x 325	65	2,5	6
3100341	176 x 325	100	3,6	6

75013

75015 Barra adaptadora / Adaptor Bar / Barre intermédiaire / Adapterschiene



REF	PARA / FOR / POUR / FÜR	
75015	3100020 / 3100040	12
75013	3100220 / 3100240 / 3100320 / 3100321 / 3100340 / 3100341	12

VER PRODUCTOS EN / SEE PRODUCTS ON / VOIR PRODUITS EN PAGE / SIEHE PRODUKTE IN

SP3



P. 453

VER PRODUCTOS EN / SEE PRODUCTS ON / VOIR PRODUITS EN PAGE / SIEHE PRODUKTE IN

POLINORM®



P. 155

BUFFET ACCESSORIES /
BUFFET & ACCESSORIES /
BUFFET ET ACCESSOIRES

MIRAMAR[®] COOKWARE

BATERÍA DE COCINA PARA PRESENTACIÓN /
DISPLAY COOKWARE /
BATTERIE DE CUISINE DE PRÉSENTATION /
Kochgeschirr zur Präsentation



ESPAÑOL

La batería pasa directamente de la cocina a su buffet en el mismo recipiente.
Variedad de utensilios de cocina para todo tipo de comidas.

ENGLISH

Cookware goes straight from the kitchen to your buffet in the same vessel.
Variety of cookware items or any menu.

FRANÇAIS

Passez directement de la cuisine au buffet sans changer de plat.
Variété d'articles pour tout type de menu.

DEUTSCH

Das Kochgeschirr kommt im selben Behälter direkt aus der Küche zum Bankett.
Auswahl an Kochbehältern für jede Art von Menü.



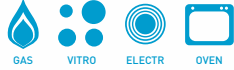

ASAS Y MANGOS BRILLANTES /
SATIN-FINISHED INTERIOR AND EXTERIOR /
DES POIGNÉES ULTRA-BRILLANTES /
MIT GLÄNZENDEN GRIFFEN



MANGOS DISEÑADOS PARA LA
SUJECIÓN DE LAS TAPAS /

HANDLE DESIGN SERVES AS A
CONVENIENT COVER REST /

LA CONCEPTION DES MANCHES ET
POIGNÉES SERT DE
REPOSECOUVERCLE /

DAS DESIGN DES GRIFFS
ERMÖGLICHT BEI DIE PRAKTISCHE
VERWENDUNG ALS DECKELHALTER

INTERIOR Y EXTERIOR SATINADOS /
MIRROR-FINISHED HANDLES /
FINITION SATINÉE À L'INTÉRIEUR ET L'EXTÉRIEUR /
EINZELNE TEILE DES KOCHGESCHIRRS INNEN UND AUßEN SATINIERT



CAPAS PLY MULTIMETAL / MULTI-PLY /
MULTI-METAL / MULTIMETALL

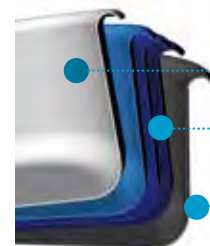

INOX - ST/STEEL
ROSTFREIER STAHL

TRI-ALUMINIUM

INOX - ST/STEEL
ROSTFREIER STAHL



49410 Cacerola baja con tapa de cúpula / Casseroles /
Faitouts avec couvercle dôme bas / Kasserolle mit Flachhaubendeckel

REF	mm	H mm	L	
49410	200 x 200	95	2,9	1
49411	241 x 241	113	4,8	1

49420 Fuente para gratinar / Oval Au Gratin / Plat à gratin ovale / Ovale Gratin-Pfanne

REF	mm	H mm	L	
49420	254 x 191	52	1,7	1
49412*	305 x 216	51	2,5	1

*Acabado brillante / *Mirror-finished interior /

*Ultra-brillant / *Durchgängige Hochglanzausführung

49416 Sartén / Sauté Pan / Sauteuse / Sautierpfanne

49416



49413

REF	mm	H mm	L	
49416	203 x 203	51	1,2	1
49413	260 x 260	48	2,1	1

49417 Paellera / French Omelet Pans / Poêle à omelette / Omelettpfanne

49417



49424

REF	mm	H mm	L	
49417	203 x 203	60	1,7	1
49424	260 x 260	60	2,9	1

49418 Sautex bombeado / Stir Fry Pan / Wok/plat de service / Anbratpfanne

49418



49428

REF	mm	H mm	L	
49418	302 x 302	94	4,9	1
49428	321 x 321	92	6,0	1

49425 Cacerola baja / Brazier Pan / Plat à braiser/ Schmorpfanne



REF	mm	H mm	L	
49425	300 x 300	89	6	1

49430 Cazo / Sauce Pans / Casserole / Kochpfann



REF	mm	H mm	L	
49430	140 x 140	68	0,9	1
49414	159 x 159	95	1,9	1

49434 Fuente / Food Pans / Plat / Speisepfanne



*Sin asas / Without handles /
Sans poignées / Kleine Ohne
49434 - 49432

Con asas / With handles /
Avec poignées / Kleine mit Griffe
49435 - 49433

REF	mm	H mm	L	
49434*	291 x 236	51	2,6	1
49435	291 x 236	51	2,6	1
49432*	373 x 300	51	4,4	1
49433	373 x 300	51	4,4	1

49431 Fuente Horno con tapa / French Oven with cover / Cocotte avec couvercle / Guseisentopf mit Deckel



REF	mm	H mm	L	
49431	363 x 282	97	6,6	1

49429 Tapa / Covers / Couvercles / Deckel



REF	PARA / FOR / POUR / FÜR	H mm	L	
49429	49428	356 x 356	120	1
49426	49418 - 49425	324 x 324	102	1
49415	49414	168 x 168	51	1
49427	49430	149 x 149	51	1
49419	49416 - 49417	203 x 203	51	1
49423	49416 - 49417	273 x 273	51	1

Plantillas / Templates / Gabarits / Schablonen



Acero inox. / Stainless Steel Plain / Inox / Edelstahl
Resina / Resin / Résine / Duroplastausführung  +150°C
Negro / Night Sky / Bleu nuit / Nachthimmel



8242014 Plantilla agujeros redondo grande y pequeño / One large and one small round / Une grande découpe ronde et une petite découpe ronde / Ein großer und ein kleiner, runder Ausschnitt

1/1





REF	mm		
8242014	536 x 324		1
8242010	536 x 324		1

8242314 Plantilla agujero oval grande / One large oval / Une grande découpe ovale / Ein großer, ovaler Ausschnitt

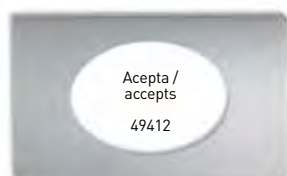
1/1





REF	mm		
8242314	536 x 324		1
8242310	536 x 324		1

8242414 Plantilla agujeros redondo grande y pequeño / One large round and one small round / Une grande découpe ronde et une petite découpe ronde / Ein großer, runder und ein kleiner, runder Ausschnitt

1/1





REF	mm		
8242414	536 x 324		1

8242514 Plantilla agujeros redondos grandes / Two large round / 2 grandes découpes rondes / 2 große, runde Ausschnitte

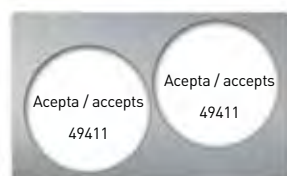
1/1





REF	mm		
8242514	536 x 324		1

8242614 Plantilla agujero redondo grande / One large round / Une grande découpe ronde / Ein großer, runder Ausschnitt

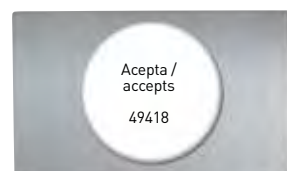
1/1





REF	mm		
8242614	536 x 324		1
8242610	536 x 324		1

8242714 Plantilla agujero oval grande / One large oval / Un grand ovale / Ein großes Oval

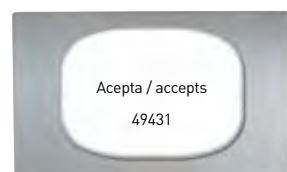
1/1



REF	mm		
8242714	536 x 324		1
8242710	536 x 324		1

Plantillas / Templates / Gabarits / Schablonen



Acero inox. / Stainless Steel Plain / Inox / Edelstahl
Resina / Resin / Résine / Duroplastausführung  +150°C
Negro / Night Sky / Bleu nuit / Nachthimmel

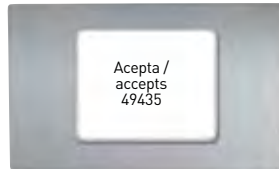

8242814 Plantilla para fuente / One small food pan /
Un petit bac à aliments / Eine kleine Speisenschale

1/1





REF	mm		
8242814	536 x 324		1
8242810	536 x 324		1

8242914 Plantilla para fuente / One large food pan /
Un grand bac à aliments / Eine grosse Speisenschale

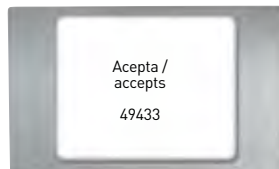
1/1





REF	mm		
8242914	536 x 324		1

8243014 Plantilla para fuente / Two small food pans /
Deux petits bacs à aliments / Zwei kleine Speisenschalen

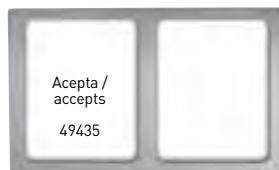
1/1





REF	mm		
8243014	536 x 324		1

8243114 Plantilla agujeros ovales grande y pequeño / One large and one medium oval /
Une grande découpe ronde et une moyenne découpe ovale / Ein großer und ein mittelgroße, ovaler Ausschnitt

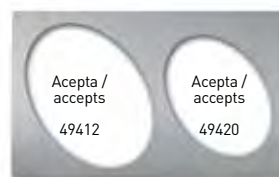
1/1





REF	mm		
8243114	536 x 324		1

8243214 Plantilla agujeros redondos medianos / Two medium oval /
Deux découpes ovales moyennes / Zwei mittelgroße, ovale Ausschnitte

1/1





REF	mm		
8243214	536 x 324		1
8243210	536 x 324		1

8243314 Plantilla agujeros redondos grande y mediano / One large and one medium round /
Une grande découpe ronde et une moyenne découpe ronde / Grosse runde Löcher Vorlage

1/1



REF	mm		
8243314	536 x 324		1

CUBIC®



Descubre la mejor presentación de buffet, porque:
es elegante, es original, ahorra espacio, ofrece múltiples y variadas combinaciones.

Discover the best buffet display, thanks to its:
Elegance, originality, space saving properties, multi-combinations.

EXCLUSIVE

PATENT PENDING



BUFFET ACCESSORIES /
BUFFET & ACCESSORIES /
BUFFET ET ACCESSOIRES

Découvrez la meilleure présentation buffet, grâce à son :

élégance, originalité, gain d'espace, multiples combinaisons possibles.

Entdecken Sie die beste Buffet-Präsentation:

Eleganz, Originalität, Platzsparend, Viele verschiedene Kombinationsmöglichkeiten.

Muebles presentación buffet / Display buffet cases / Meubles présentation buffet / Buffet Präsentationsmöbel

ADAPTADO A MEDIDAS GASTRONORM /
SUITABLE FOR GASTRONORM SIZES /
ADAPTÉS AUX MESURES GASTRONORME /
GEEIGNET FÜR GASTRONORMGRÖSSEN

DOS COLORES DISPONIBLES:
BLANCO Y NEGRO /

TWO COLORS AVAILABLE:
WHITE AND BLACK /

DEUX COULEURS DISPONIBLES:
BLANC ET NOIR /

IN ZWEI FARBEN LIEFERBAR:
SCHWARZ UND WEISS



FABRICADOS EN MADERA CON
TRATAMIENTO HIDRÓFUGO
ESPECIAL, DE FÁCIL LIMPIEZA /

MADE OF WOOD WITH SPECIAL
WATERPROOF TREATMENT, EASY TO
CLEAN /

FABRIQUÉ EN BOIS AVEC UN
TRAITEMENT HYDROFUGE SPÉCIAL,
FACILE À NETTOYER /

HERGESTELLT AUS HOLZ, SPEZIELL
WASSERABWEISEND BEHANDELT,
EINFACH ZU REINIGEN

Carro madera presentación buffet / Wooden buffet serving trolley / Chariot buffet en bois présentation buffet / Buffetservierwagen aus Holz

ELEGANTE COMBINACIÓN DE MADERA Y ALUMINIO /
OUTSTANDING COMBINATION OF WOOD AND ALUMINIUM /
COMBINAISON ÉLÉGANTE EN BOIS ET EN ALUMINIUM /
ELEGANTE KOMBINATION AUS HOLZ UND ALUMINIUM

ADAPTADO A MEDIDAS
GASTRONORM /

SUITABLE FOR
GASTRONORM SIZES /

ADAPTÉS AUX MESURES
GASTRONORME /

GEEIGNET FÜR
GASTRONORMGRÖSSEN

TRATAMIENTO HIDRÓFUGO
ESPECIAL, DE FÁCIL LIMPIEZA /

WOOD WITH SPECIAL
WATERPROOF TREATMENT,
EASY TO CLEAN /

BOIS AVEC UN TRAITEMENT
HYDROFUGE SPÉCIAL,
FACILE À NETTOYER /

SPEZIELLE WASSERABWEISENDE
BEHANDLUNG, EINFACH ZU
REINGEN



POSIBILIDAD DE CONVERTIR EL
CARRO EXPOSITOR EN MESA DE
PRESENTACIÓN /

POSSIBLE TRANSFORMATION
FROM AN EXPOSITOR TROLLEY
TO A PRESENTATION TABLE /

POSSIBILITÉ DE TRANSFORMER
LE CHARIOT D'EXPOSITION EN
UNE TABLE DE PRÉSENTATION /

MÖGLICHKEIT DEN
BUFFETWAGEN IN EINEN
PRÄSENTATIONSTISCH ZU
VERWANDELN

Cubos y estantes / Cubes & shelves / Cubes et tablettes / Behälter und Regale

EXCLUSIVE

PATENT PENDING



Cubo

Con tapa superior transformable en mini estante, apilables entre sí, múltiples combinaciones posibles, ahorro de espacio durante el almacenaje de las piezas, tratamiento hidrófugo especial.

Cubes

Top cover convertible on mini shelf, stackable, multicombinations, saving space when storing parts, special waterproof treatment.



Estantes

Tres longitudes: 50, 80 y 100 cm, dos profundidades: 18 y 35 cm, madera indeformable, dos colores: blanco y negro. Posibilidad de combinación de colores, tratamiento hidrófugo especial.

Shelves

Three lengths: 50, 80 and 100 cm, two depths: 18 and 35 cm, undeformable wood, two colors: white and black. Possibility of color combinations, special waterproof treatment.

Cubes

Couvercle transformable en mini rayon, empilables, multiples combinaisons possibles, gain d'espace pour le stockage des composants, traitement hydrofuge spécial.

Behälter

Mit Deckeloberteil umwandelbar in ein Minieregale, stapelbar. Viele verschiedene Kombinationsmöglichkeiten, platzsparend bei Lagerung der Teile, spezielle Wasserabweisende Behandlung.

Tablettes

Trois longueurs: 50, 80 et 100 cm, deux profondeurs: 18 et 35 cm. Bois indéformable, deux couleurs: blanc et noir. Combinaison de couleurs possible, traitement hydrofuge spécial.

Regale

Drei Längen: 50, 80 und 100 cm., Zwei Tiefen: 18 und 35 cm. Unverformbares Holz, zwei Farben: weiss oder schwarz. Möglichkeit der Farbkombinierung, spezielle wasserabweisende Behandlung.

EXCLUSIVE

PATENT PENDING



Un buffet como nunca antes habías imaginado /
A buffet display you could never have dreamt of /
Un buffet comme vous ne l'aviez jamais imaginé /
Ein Buffet wie Sie es sich früher nie vorstellen konnten



BUFFET ACCESSORIES /
BUFFET & ACCESSORIES /
BUFFET ET ACCESSOIRES

**Máxima versatilidad para tus buffets /
Maximum versatility for your buffets /
Versatilité optimum pour vos buffets /
Maximale Vielfältigkeit ihrer Buffets**

EXCLUSIVE

PATENT PENDING

Con Cubic, ahora es el producto que se adapta a sus necesidades /
With Cubic, you now have the product that adapts to your needs /
Avec Cubic, c'est dorénavant le produit qui s'adapte à vos besoins /
Mit Cubic haben Sie jetzt das Produkt, welches sich Ihren Bedürfnissen anpasst





**MAYOR COMODIDAD Y FUNCIONALIDAD /
GREATER CONVENIENCE AND FUNCTIONALITY /
PLUS PRATIQUE ET PLUS FONCTIONEL /
HÖHERER KOMFORT UND FUNKTIONALITÄT**



Bandejas apilables entre sí /
Stackable trays /
Plateaux empilables entre eux /
Stapelbare tablett

**MODULARIDAD A LA MÁXIMA EXPRESIÓN /
MODULARITY THAT REFLECTS MAXIMUM
EXPRESSION /
MODULARITÉ À SON EXPRESSION MAXIMALE /
MODULVIELFALT FÜR DEN MAXIMALEN AUSDRUCK**



- Permite optimizar espacio de exposición
- Reduce el tiempo de montaje y desmontaje
- Facilidad de transporte y almacenaje /

- Allows you to maximize display space
- Reduces assembly and disassembly time
- Easy transportation and storage /

- Permet d'optimiser l'espace d'exposition
- Réduit le temps de montage et de démontage
- Facilité de transport et entreposage /

- Optimiert den platz der präsentation
- Reduzierung der aufbau- und abbauzeit
- Einfacher transport und lagerung



**PERSONALIZACIÓN DEL BUFFET /
PERSONALISE YOUR BUFFET /
PERSONNALISATION DU BUFFET /
PERSONALIESIERUNG DES BUFFETS**

Con los soportes de metacrilato se puede identificar el contenido de cada uno de los recipientes, de una forma ágil y elegante /

Methacrylate supports allow you to identify the contents of each container, in an agile and elegant way /

Grâce aux supports en méthacrylate on peut identifier le contenu de chacun des récipients de façon rapide et élégante /

Mit den ständern aus metaakrylat können sie den inhalt jedes einzelnen behälters identifizieren, in einer geschickten und eleganten art und weise



P905.504 Conjunto soporte 4 bols cuadrados / Presentation kit for 4 square bowls / Kit support 4 bols carrés / Ständer set mit 4 quadratischen Schalen

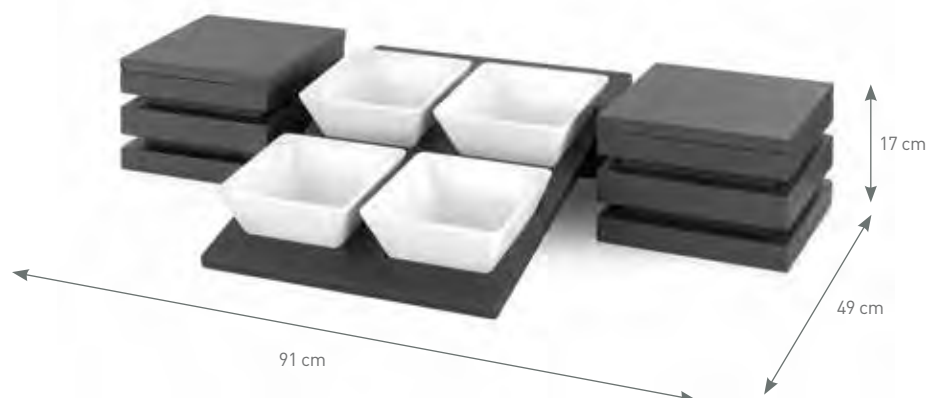

REF	
P905.504	1

Incluye: 2 cubos con tapa + 1 travesaño de 50 cm + 1 presentador de 4 bols + 4 bols de melamina.

Includes: 2 cubes with lid + 1 crossbar 50 cm length + 1 displayer for 4 bowls + 4 melamine bowls.

Inclus: 2 cubes avec couvercle + 1 longeron 50 cm + 1 présentoir pour 4 bols + 4 bols mélamine.

Inklusive: 2 Behälter mit Deckel + 1 Traverse von 50 cm + 1 Halter für 4 Schalen + 4 Schalen aus Melamin.

P905.506 Conjunto soporte 6 bols cuadrados / Presentation kit for 6 square bowls / Kit support 6 bols carrés / Ständer set mit 6 quadratischen Schalen

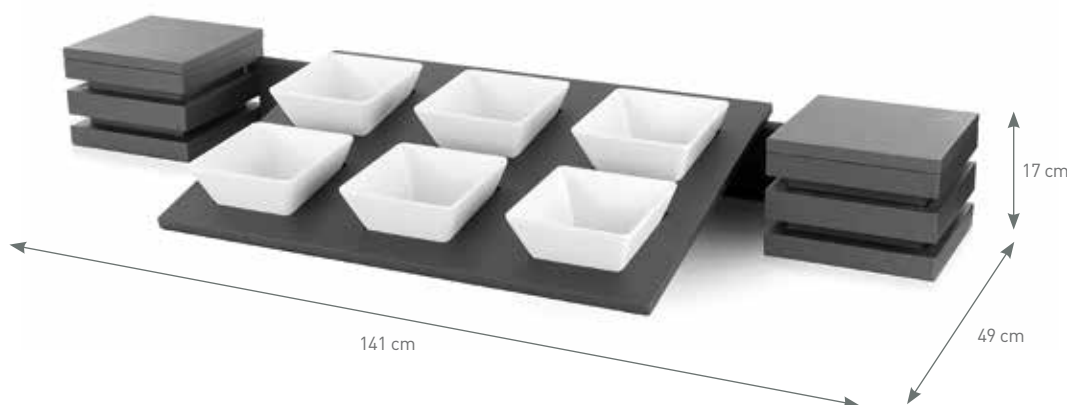

REF	
P905.506	1

Incluye: 2 cubos con tapa + 1 travesaño de 100 cm + 1 presentador de 6 bols + 6 bols de melamina.

Includes: 2 cubes with lid + 1 crossbar 100 cm length + 1 displayer for 6 bowls + 6 melamine bowls.

Inclus: 2 cubes avec couvercle + 1 longeron 100 cm + 1 présentoir pour 6 bols + 6 bols mélamine.

Inklusive: 2 Behälter mit Deckel + 1 Traverse von 100 cm + 1 Halter für 6 Schalen + 6 Schalen aus Melamin.

P905.516 Conjunto 2 niveles soporte 6 bols / Two levels presentation kit for 6 square bowls / Kit support 6 bols carrés deux niveaux / 2 Ebenen Ständer set mit 6 quadratischen Schalen

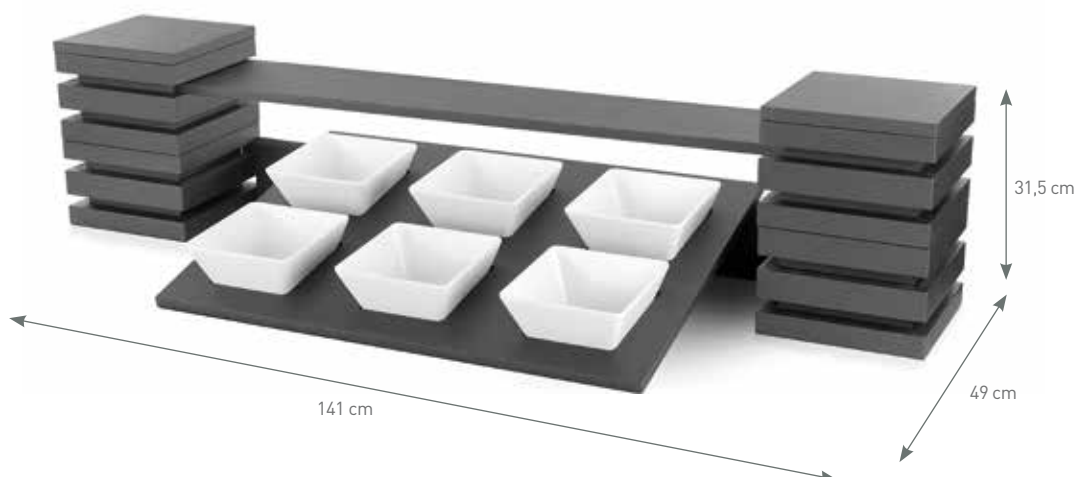

REF	
P905.516	1

Incluye: 4 cubos con tapa + 1 travesaño de 100 cm + 1 presentador de 6 bols + 6 bols de melamina + 1 estante estrecho de 100 cm.

Includes: 4 cubes with lid + 1 crossbar 100 cm length + 1 displayer for 6 bowls + 6 melamine bowls + 1 narrow shelf 100 cm.

Inclus: 4 cubes avec couvercle + 1 longeron 100 cm + 1 présentoir pour 6 bols + 6 bols mélamine + 1 tablette étroite 100 cm.

Inklusive: 4 Behälter mit Deckel + 1 Traverse von 100 cm + 1 Halter für 6 Schalen + 6 Schalen aus Melamin + 1 schmales Regal von 100 cm.

P905.508 Conjunto soporte 8 bols cuadrados / Presentation kit for 8 square bowls /
Kit support 8 bols carrés / Ständerset mit 8 quadratischen Schalen

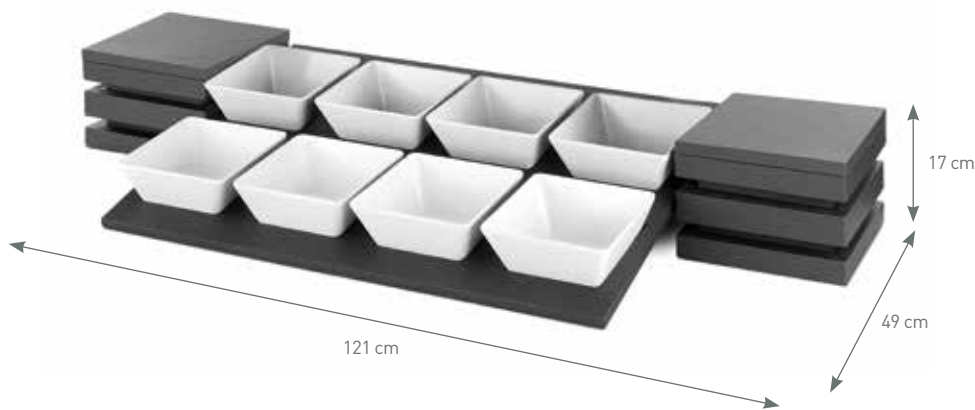

REF	
P905.508	1

Incluye: 2 cubos con tapa + 1 travesaño de 80 cm + 2 presentadores de 4 bols + 8 bols de melamina.

Includes: 2 cubes with lid + 1 crossbar 80 cm length + 2 displays for 4 bowls + 8 melamine bowls .

Inclus: 2 cubes avec couvercle + 1 longeron 80 cm + 2 présentoirs pour 4 bols + 8 bols mélamine.

Inklusive: 2 Behälter mit Deckel + 1 Traverse von 80 cm + 1 Halter für 4 Schalen + 8 Schalen aus Melamin.

P905.518 Conjunto 2 niveles soporte 8 bols / Two levels presentation kit for 8 square bowls /
Kit support 8 bols carrés deux niveaux / 2 Ebenen Ständerset mit 8 quadratischen Schalen

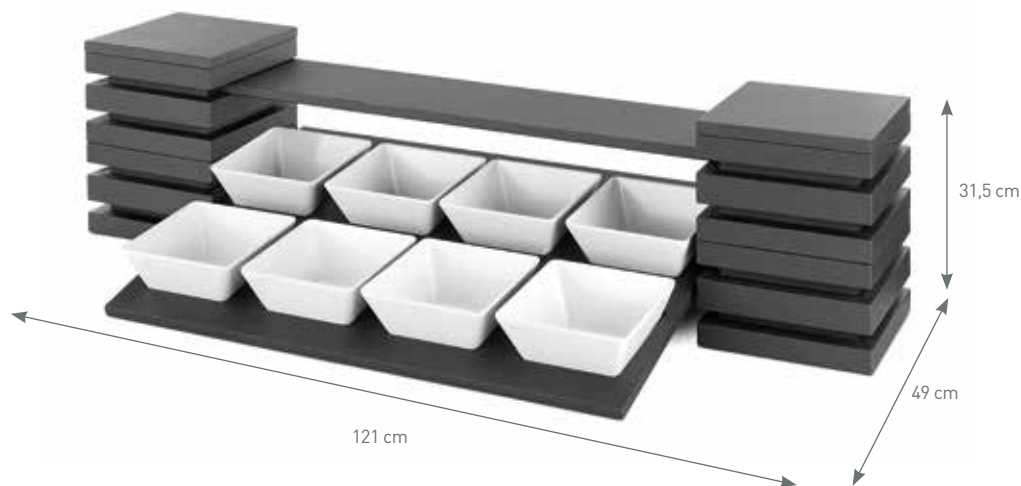

REF	
P905.518	1

Incluye: 4 cubos con tapa + 1 travesaño de 80 cm + 2 presentadores de 4 bols + 8 bols de melamina + 1 estante estrecho de 80 cm.

Includes: 4 cubes with lid + 1 crossbar 80 cm length + 2 displays for 4 bowls + 8 melamine bowls + 1 narrow shelf 80 cm.

Inclus: 4 cubes avec couvercle + 1 longeron 80 cm + 2 présentoirs pour 4 bols + 8 bols mélamine + 1 tablette étroite 80 cm.

Inklusive: 4 Behälter mit Deckel + 1 Traverse von 80 cm + 1 Halter für 4 Schalen + 8 Schalen aus Melamin + 1 schmales Regal von 80 cm.

P905.400 Conjunto básico estante 2 niveles / Basic two levels presentation kit /
Kit basique présentation 2 niveaux / Basisregalset 2 Ebenen



REF	
P905.400	1

Incluye: 4 cubos con tapa + 1 estante ancho de 100 cm + 1 estante estrecho de 100 cm.

Includes: 4 cubes with lid + 1 wide shelf 100 cm + 1 narrow shelf 100 cm.

Inclus: 4 cubes avec couvercle + 1 tablette large 100 cm + 1 tablette étroite 100 cm.

Inklusive: 4 Behälter mit Deckel + 1 breites Regal von 100 cm + 1 schmales Regal von 100 cm.

P905.410 Conjunto estante dos niveles forma "L" / "L" shape two levels presentation kit /
Kit présentation "L" 2 niveaux / Regalset 2 Ebenen "L" Form

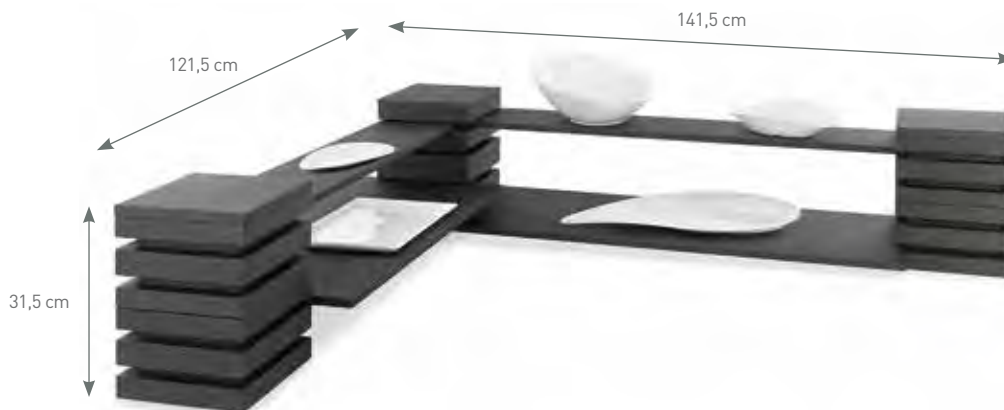

REF	
P905.410	1

Incluye: 6 cubos con tapa + 1 estante ancho de 100 cm + 1 estante estrecho de 100 cm + 1 estante ancho de 80 cm + 1 estante estrecho de 80 cm.

Includes: 6 cubes with lid + 1 wide shelf 100 cm + 1 narrow shelf 100 cm + 1 wide shelf 80 cm + 1 narrow shelf 80 cm.

Inclus: 6 cubes avec couvercle + 1 tablette large 100 cm + 1 tablette étroite 100 cm + 1 tablette large 80 cm + 1 tablette étroite 80 cm.

Inklusive: 6 Behälter mit Deckel + 1 breites Regal von 100 cm + 1 schmales Regal von 100 cm + 1 breites Regal von 80 cm + 1 schmales Regal von 80 cm.

P905.300 Conjunto 2 bandejas presentación 40x40 cm / Two trays 40x40 cm presentation kit /
Kit présentation pour deux plateaux 40x40 cm / Set mit 2 Präsentationstabletts 40x40 cm



REF	
P905.300	1

Incluye: 4 cubos con tapa + 1 travesaño de 100 cm + 2 bandejas presentación de 40 x 40 cm.

Includes: 4 cubes with lid + 1 crossbar 100 cm length + 2 serving trays 40 x 40 cm.

Inclus: 4 cubes avec couvercle + 1 longeron 100 cm + 2 plateaux présentation 40 x 40 cm.

Inklusive: 4 Behälter mit Deckel + 1 Traverse von 100 cm + 2 tablettts 40 x 40 cm.

P905.310 Conjunto 2 niveles bandejas 40x40 cm /
Two levels presentation kit for 40x40 cm trays /
Kit présentation 2 niveaux pour plateaux 40x40 cm /
Set 2 Ebenen mit 2 Präsentationstabletts 40 x 40 cm



REF	
P905.310	1

Incluye: 6 cubos con tapa + 1 travesaño de 100 cm + 2 bandejas presentación de 40 x 40 cm + 1 estante estrecho de 100 cm.

Includes: 6 cubes with lid + 1 crossbar 100 cm length + 2 serving trays 40 x 40 cm + 1 narrow shelf 100 cm.

Inclus: 6 cubes avec couvercle + 1 longeron 100 cm + 2 plateaux présentation 40 x 40 cm + 1 tablette étroite 100 cm.

Inklusive: 4 Behälter mit Deckel + 1 Traverse von 100 cm + 2 Präsentationstabletts 40 x 40 cm + 1 schmales Regal 100 cm.

P905.320

**Conjunto 2 bandejas 60x40 cm / Two trays 60x40 cm presentation kit /
Kit présentation pour deux plateaux 60x40 cm / Set mit 2 Präsentationstabletts 60x40 cm**





REF	
P905.320	1

Incluye: 2 cubos con tapa + 1 travesaño de 100 cm + 2 bandejas presentación de 60 x 40 cm.
Includes: 2 cubes with lid + 1 crossbar 100 cm length + 2 serving trays 60 x 40 cm.
Inclus: 2 cubes avec couvercle + 1 longeron 100 cm + 2 plateaux présentation 60 x 40 cm.
Inklusive: 2 Behälter mit Deckel + 1 Traverse von 100 cm + 2 Präsentationstabletts 60 x 40 cm.

P905.340

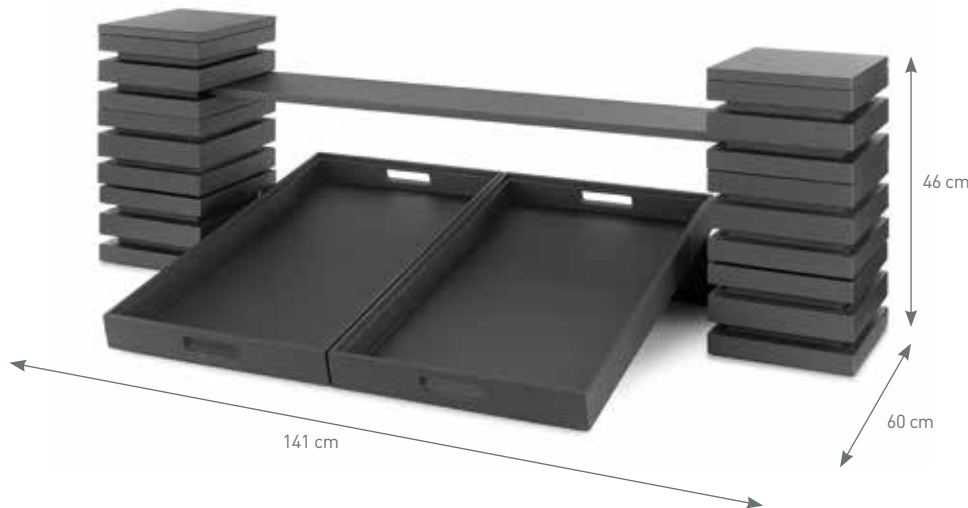
**Conjunto 2 niveles para bandejas 60x40 cm / Two levels for trays 60x40 cm presentation kit /
Kit présentation 2 niveaux pour plateaux 60x40 cm / Set 2 Ebenen mit 2 Präsentationstabletts 60x40 cm**



REF	
P905.340	1

Incluye: 6 cubos con tapa + 1 travesaño de 100 cm + 2 bandejas presentación de 60 x 40 cm + 1 estante estrecho de 100 cm.
Includes: 6 cubes with lid + 1 crossbar 100 cm length + 2 serving trays 60 x 40 cm + 1 narrow shelf 100 cm.
Inclus: 6 cubes avec couvercle + 1 longeron 100 cm + 2 plateaux présentation 60 x 40 cm + 1 tablette étroite 100 cm.
Inklusive: 6 Behälter mit Deckel + 1 Traverse von 100 cm + 2 Präsentationstabletts 60 x 40 cm + 1 schmales Regal 100 cm.

P905.200

**Conjunto buffet desayuno / Breakfast buffet displayer kit /
Kit présentation petit déjeuner / Frühstücksbuffetset**



REF	
P905.200	1

Incluye: 2 cubos con tapa + 1 travesaño de 80 cm + 1 bandeja presentación de 60 x 40 cm + 1 kit completo dispensador de zumos de 6 lts.
Includes: 2 cubes with lid + 1 crossbar 80 cm length + 1 serving tray 60 x 40 cm + 1 complet kit juice dispenser 6 lts.
Inclus: 2 cubes avec couvercle + 1 longeron 80 cm + 1 plateau présentation 60 x 40 cm + 1 kit complet distributeur à jus 6 lts.
Inklusive: 2 Behälter mit Deckel + 1 Traverse von 80 cm + 2 Präsentationstabletts 60 x 40 cm + 1 komplettes Saftspendenset 6 Liter.

P904.800 Dispensador zumos 6 lts. /
Juice dispenser 6 lts. /
Distributeur à jus 6 lts /
Saftspender 6 Liter



REF	mm	H mm	L	
P904.800	230 x 390	490	6	1

Superficie superior de Abedúl finlandés / Upper Surface Of Finnish Birch /
Surface supérieure en bouleau finlandais / Oberfläche Finnischer Birke.

P904.790 Expositor GN 2/3, tres niveles /
Three levels 2/3 GN stand /
Présentoir 3 niveaux pour GN 2/3 /
Ständer GN 2/3 drei Ebenen



REF	mm	H mm	
P904.790	650 x 380	590	1

Incluye: 3 cubetas GN 2/3 20 mm / Includes: 3 GN containers 2/3 20 mm /
Inclus: 3 bags GN 2/3 20 mm / Inklusive: 3 GN 2/3 20 mm.

VER PRODUCTOS EN / SEE PRODUCTS ON / VOIR PRODUITS EN PAGE / SIEHE PRODUKTE IN



MELAMINA /
MELAMINE /
MÉLAMINE /
MELAMIN

P. 360 - 403

EXCLUSIVE



P904.350

**Bandeja GN presentación pinchos / GN skewer serving tray /
Plateau GN présentation piques / GN Servierplatte für Spiesschen**



GN 1/1

REF	mm	H mm	AGUJEROS HOLES Ø mm	PINCHOS PIQUES	
P904.350	539 x 335	77	4	84	1

Incluye: bandeja madera + bandeja melamina roble
+ soporte interior pinchos /
Includes: wooden tray + oak melamine tray
+ interior skewer stand /
Inclus : plateau bois + plateau mélamine chêne
+ support intérieur piques /
Enthält: Holztablett + Platte aus Eiche/Melamin
+ Lochplatte für Spiesschen

P904.360

**Soporte presentación pincho estante/ Skewer serving rack stand /
Support présentation piques plaque / Schmale Regalhalterung zum Angebot von Spiesschen**

INOX /
ST/STEEL /
EDELSTAHL



REF	mm	H mm	AGUJEROS HOLES Ø mm	PINCHOS PIQUES	
P904.360*	448 x 182	42	4	40	1

* Para estante / For shelf /
Pour tablette / Für holsregal
P904.650 / P904.651.

Ver en página / Refer to page /
Consulter page / Siehe
P. 438

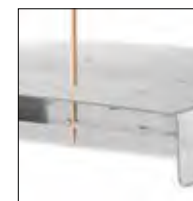

VER PRODUCTOS EN / SEE PRODUCTS ON / VOIR PRODUITS EN PAGE / SIEHE PRODUKTE IN

**TAPAS ACERO INOXIDABLE PARA PLATOS /
STAINLESS STEEL PLATE COVERS /
INOX COUVERCLES À ASSIETTE /
EDELSTAHL-TELLERHAUBEN**

P. 509



ROOM SERVICE



P904.780 Bandeja porta-cubiertos / Cutlery-holder tray / Plateau porte-couverts / Beteckbehälter

4 compartimentos / 4 compartments /
4 compartiments / 4 Fächer
303 x 115 mm

Apilables.
Stackables.
Empilables.
Stapelbar.



GN 1/1

REF	mm	H mm	
P904.780	539 x 335	77	1

P904.740 Bandeja presentación / Serving tray / Plateau présentation / Präsentationstablatt

Apilables.
Stackables.
Empilables.
Stapelbar.



REF	mm	H mm	
P904.740	400 x 400	65	1

P904.760 Bandeja servicio y presentación / Serving tray / Plateau service et présentation / Servier- und Präsentationstablatt

Apilables.
Stackables.
Empilables.
Stapelbar.



REF	mm	H mm	
P904.760	600 x 400	65	1

IDEA!

Perfecta para servicio de habitaciones.
Room service tray.
Plateau idéal pour service de chambre.
Perfekt für den Zimmerservice.

P904.711 Bandeja servicio y presentación GN 1/1 / 1/1 GN serving tray / Plateau service et présentation GN 1/1 / Servier- und Präsentationstablatt GN 1/1

Apilables.
Stackables.
Empilables.
Stapelbar.



GN 1/1

REF	mm	H mm	
P904.711	539 x 335 (1/1)	77	1

No incluye cubeta gastronorm 1/1.
1/1 Gastronorm container not included.
Bac gastronorme 1/1 non inclus.
Nicht inklusive Gastronormbehälter 1/1.

P904.850

Mesita buffet GN 1/1 + taco madera /
1/1 GN wooden table + cutting board /
Table GN 1/1 en bois + planche à découper /
Buffettischchen GN 1/1 + Holzschneidebrett



REF	mm	H mm	
P904.850	530 x 325	120	1

P904.720

Servilletero y dispensador bolsas te y azúcar /
Napkin and tea & sugar bags dispenser /
Distributeur serviettes et des saquettes thé & sucre /
Serviettenhalter und Tee- und Zuckerbeutelhalter



REF	mm	H mm	
P904.720	220 x 220	55	1
P904.725	220 x 220	55	1

P904.155

Enfriador botellas buffet / Buffet wine cooler /
Rafraîchisseur bouteilles / Buffetflaschenkühler



REF	mm	H mm	
P904.155	570 x 370	145	1

Incluye: marco madera + cubeta GN 1/1 150 mm.
Includes: wooden frame + 1/1 GN pan 150 mm.
Inclus: cadre en bois + bac GN 1/1 150 mm.
Inklusive: Holzrahmen + GN 1/1 Behälter 150 mm.

P904.810

Mesita buffet baja + taco madera /
Low wooden table + cutting board /
Table basse en bois + planche à découper /
Flaches Buffettischchen + Holzschneidebrett



REF	mm	H mm	
P904.810	325 x 220	120	1
P904.820	325 x 220	165	1
P904.890	325 x 220	210	1

P20.072

Portamenús metacrilato / Methacrylate holder /
Porte-menus méthacrylate / Methacrylat Menühalter



REF	cm	
P20.072	6 x 6	1

Enfriador botellas caja madera /
Wine cooler wooden box /
Boîte en bois refroidissement bouteilles /
Flaschenkühler Holzkiste

P904.157



REF	mm	H mm	
P904.157	325 x 265	150	1

Incluye: caja madera + cubeta GN 1/2 150 mm.
Includes: wooden box + 1/2 GN pan 150 mm.
Inclus: boîte en bois + bac GN 1/2 150 mm.
Inklusive: Holzkiste + GN 1/2 Behälter 150 mm.

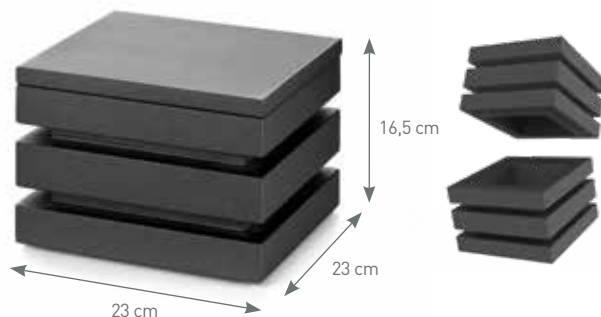
P904.600 Cubo con tapa madera / Wooden cube with lid /
Cube en bois avec couvercle / Behälter mit Holzdeckel

REF		
P904.600	●	1
P904.601*	○	1

● Negro / Black / Noir / Schwarz
○ Blanco / White / Blanc / Weiss

*Disponible bajo pedido. Consultar cantidad mínima /
Available upon request. Check minimum order quantity /
Disponibile sur commande. Consulter quantité minimum /
Verfügbar auf Anfrage. Überprüfen Sie die Mindestmenge

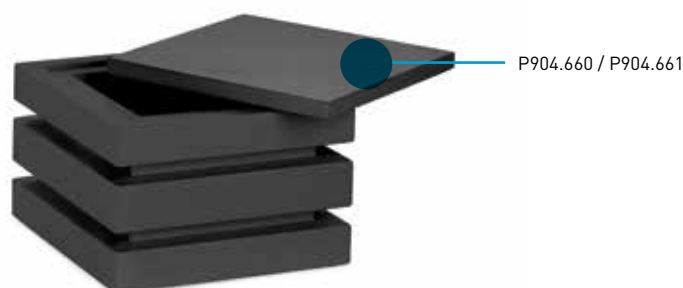
P904.660 Tapa madera / Wooden lid / Couvercle en bois / Holzdeckel

REF		
P904.660	●	1
P904.661*	○	1

● Negro / Black / Noir / Schwarz
○ Blanco / White / Blanc / Weiss

*Disponible bajo pedido. Consultar cantidad mínima /
Available upon request. Check minimum order quantity /
Disponibile sur commande. Consulter quantité minimum /
Verfügbar auf Anfrage. Überprüfen Sie die Mindestmenge

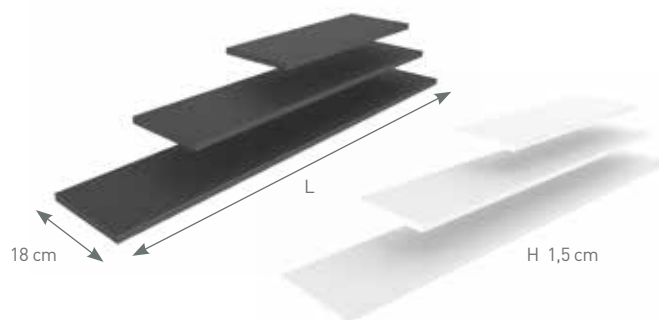
P904.650 Estante madera estrecho / Wooden narrow shelf / Tablette en bois étroite / Schmales Holzregal

REF		L cm	
P904.650	●	50	1
P904.680	●	80	1
P904.610	●	100	1
P904.651*	○	50	1
P904.681*	○	80	1
P904.611*	○	100	1

● Negro / Black / Noir / Schwarz
○ Blanco / White / Blanc / Weiss

*Disponible bajo pedido. Consultar cantidad mínima /
Available upon request. Check minimum order quantity /
Disponibile sur commande. Consulter quantité minimum /
Verfügbar auf Anfrage. Überprüfen Sie die Mindestmenge

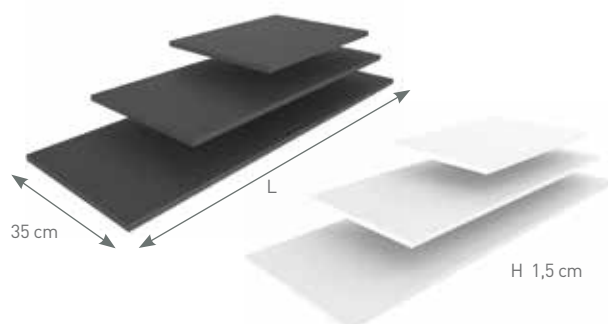
P904.652 Estante madera ancho / Wooden wide shelf / Tablette en bois large / Breites Holzregalbrett

REF		L cm	
P904.652	●	50	1
P904.682	●	80	1
P904.612	●	100	1
P904.653*	○	50	1
P904.683*	○	80	1
P904.613*	○	100	1

● Negro / Black / Noir / Schwarz
○ Blanco / White / Blanc / Weiss

*Disponible bajo pedido. Consultar cantidad mínima /
Available upon request. Check minimum order quantity /
Disponibile sur commande. Consulter quantité minimum /
Verfügbar auf Anfrage. Überprüfen Sie die Mindestmenge

P904.950 Travesaño soporte bandejas / Crossbar buffet trays /
Longerons pour plateaux buffet / Tablethaltertraverse



REF	mm	H mm	
P904.950	500 x 124	20	1
P904.980	800 x 124	20	1
P904.990	1000 x 124	20	1



P904.937 Presentador 4 bols melamina cuadrados / Displayer for 4 melamine bowls /
Présentoir 4 bols mélamine / Halter für 4 quadratische Melaminschalen



REF	mm	H mm	
P904.937	375 x 500	15	1

Para bols cuadrados 180 x 180 /
For square bowls 180 x 180 /
Pour bols carrés 180 x 180 /
Für quadratische Schalen 180 x 180
REF. P22.202

P904.975 Presentador 6 bols melamina cuadrados / Displayer for 6 melamine bowls /
Présentoir 6 bols mélamine / Halter für 6 quadratische Melaminschalen



REF	mm	H mm	
P904.975	750 x 500	15	1

Para bols cuadrados 180 x 180 /
For square bowls 180 x 180 /
Pour bols carrés 180 x 180 /
Für quadratische Schalen 180 x 180
REF. P22.202

VER PRODUCTOS EN / SEE PRODUCTS ON / VOIR PRODUITS EN PAGE / SIEHE PRODUKTE IN

BOL CUADRADO HONDO /
DEEP SQUARED BOWL /
BOL CARRÉ /
TIEFE QUADRATISCHE SCHÜSSEL



P. 384

P904.165 Buffet perforado / Perforated buffet display / Buffet perforé / Gelochte Buffetvitrine



REF	mm	H mm	
P904.165	570 x 370	310	1

Incluye: marco madera + bandeja perforada gn 1/1 65 mm + cubeta GN 1/1 20 mm + cúpula roll-top.
Includes: wooden frame + perforated 1/1 GN pan 65 mm + gastronorm pan 1/1 20 mm + roll-top lid.
Inclus: cadre en bois + bac gn 1/1 65 mm perforé + bac GN 1/1 20 mm + couvercle roll-top.
Inklusive: Holzrahmen + gelochtes Tablett GN 1/1 Behälter 65 mm + GN 1/1 Behälter 20 mm + Rolldeckel.

P904.120 Buffet estandar / Standard buffet display / Buffet standard / Standardbuffet



REF		mm	H mm	
P904.120	●	570 x 370	310	1
P904.120W*	○	570 x 370	310	1

Incluye: marco madera + 2 u. cubeta GN 1/1 20 mm + cúpula roll-top.
Includes: wooden frame + 2u. 1/1 GN 1/1 20 mm + roll-top lid.
Inclus: cadre en bois + 2 u. bacs GN 1/1 20 mm + couvercle roll-top.
Inklusive: Holzrahmen + 2 GN 1/1 Behälter 20 mm + Rolldeckel.

- Negro / Black / Noir / Schwarz
- Blanco / White / Blanc / Weiss

*Disponible bajo pedido. Consultar cantidad mínima /
Available upon request. Check minimum order quantity /
Disponible sur commande. Consulter quantité minimum /
Verfügbar auf Anfrage. Überprüfen Sie die Mindestmenge

P904.113 Buffet triple / Triple buffet display / Buffet triple / Dreifach Buffetvitrine



REF	mm	H mm	
P904.113	570 x 370	310	1

Incluye: marco madera + 3 cubetas GN 1/3 65 mm + cubeta GN 1/1 20 mm + cúpula roll-top.
Includes: wooden frame + 3 units 1/3 GN pans 65 mm + GN pan 1/1 20 mm + roll-top lid.
Inclus: cadre en bois + 3 bacs GN 1/3 65 mm + bac GN 1/1 20 mm + couvercle roll-top.
Inklusive: Holzrahmen + 3 GN 1/3 65 mm Behälter + 1 GN 1/1 Behälter 20 mm + Rolldeckel.

P904.140 Buffet quesos / Cheese buffet display / Buffet fromage / Buffetvitrine für Käse



REF	mm	H mm	
P904.140	570 x 370	310	1

Incluye: marco madera + bandeja corte madera + cubeta GN 1/1 20 mm + cupula roll-top.
Includes: wooden frame + wooden cutting board + gastro-norm pan 1/1 20 mm + roll-top lid.
Inclus: cadre en bois + planque à découper en bois + bac GN 1/1 20 mm couvercle roll-top.
Inklusive: Holzrahmen + Holzschneidebrett + 1 GN 1/1 Behälter 20 mm + Rolldeckel.

P904.145 Buffet pan / Bread buffet display / Buffet pain / Buffet Brotplatte



REF	mm	H mm	
P904.145	570 x 370	145	1

Incluye: marco madera + cortador pan madera + cubeta GN 1/1 20 mm.
Includes: wooden frame + bread cutting board + 1/1 GN container 20 mm.
Inclus: cadre en bois + plaque à découper pain en bois + bac GN 1/1 20 mm.
Inklusive: Holzrahmen + Holzbrotschneidebrett + 1 GN 1/1 Behälter 20 mm.

P904.160 Buffet pizarra melamina / Melaminese slate buffet displayer / Mélamine buffet ardoise / Buffet Melaminschiefertafel



REF	mm	H mm	
P904.160	570 x 370	145	1

Incluye: marco madera + tabla pizarra melamina + cubeta GN 1/1 20 mm.
Includes: wooden frame + melamine slate board + 1/1 GN container 20 mm.
Inclus: cadre en bois + plaque ardoise en mélamine + bac GN 1/1 20 mm.
Inklusive: Holzrahmen + Melaminschiefertafel + 1 GN 1/1 Behälter 20 mm.

VER PRODUCTOS EN / SEE PRODUCTS ON / VOIR PRODUITS EN PAGE / SIEHE PRODUKTE IN

PLACA ENFRIADORA /
COOLING PLATE /
PLAQUE RÉFRIGÉRANTE /
KÄLTEPLATTE



P. 471

P904.200 Marco madera / Wooden frame / Cadre en bois / Holzrahmen



P904.200

REF		mm	H mm	
P904.200	●	570 x 370	145	1
P904.100*	○	570 x 370	145	1

- Negro / Black / Noir / Schwarz
- Blanco / White / Blanc / Weiss

*Disponible bajo pedido. Consultar cantidad mínima /
Available upon request. Check minimum order quantity /
Disponibile sur commande. Consulter quantité minimum /
Verfügbar auf Anfrage. Überprüfen Sie die Mindestmenge

P904.400 Tapete isotérmico / Isothermal mat / Tapis isotherme / Isothermische Matte



P904.400

REF	mm	H mm	
P904.400	470 x 260	20	1

FRÍO / COLD /
FROID / KALT

CALIENTE / HOT /
CHAUD / WARM

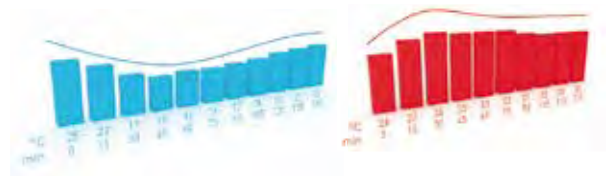

P904.500 Placa enfriadora / Cooling plate /
Plaque réfrigérante / Kühlakku



● - 12 °C

Adaptable a cubeta GN 1/1.
Adjustable to 1/1 GN pan.
Adaptable à bac GN 1/1.
Geeignet Für GN 1/1 Behälter.

REF	mm	H mm	
P904.500	475 x 277	30	1

P904.142 Cortador pan madera /
Wooden bread cutting board /
Plaque à découper pain en bois /
Brotschneidebrett aus Holz

GN 1/1



REF	mm	H mm	
P904.142	530 x 325	20	1

VER PRODUCTOS EN / SEE PRODUCTS ON / VOIR PRODUITS EN PAGE / SIEHE PRODUKTE IN

TAPA ROLL-TOP / ROLL-TOP LID /
COUVERCLE ROLL-TOP / ROLLDECKEL



P. 455

P904.146 Cortador pan madera /
Wooden bread cutting board /
Plaque à découper pain en bois /
Brotschneidebrett aus Holz



REF	mm	H mm	
P904.146	520 x 315	20	1

P904.721 Soporte bolsas te y azúcar /
Tea & sugar bag holder /
Support pour saquettes de thé & sucre /
Tee- & Zuckerbeutelhalter



Para / For / Pour / Für ref. P904.720

REF	mm	H mm	
P904.721	198 x 198	49	1

P904.807

Contenedor acrílico 6 Lts dispensador zumos con tapa /
6 Lts acrylic container with lid for juice dispenser /
Conteneur acrylic 6 Lts avec couvercle pour distributeur à jus /
6 Liter Acrylbehälter mit Deckel für Saftspender



REF	Ø mm	H mm	Lts	
P904.807	220	280	6	1

P904.804 Taco madera para mesita buffet /
Cutting board for wooden table /
Planche à découper pour table en bois /
Holzschneidebrett für Buffettisch

(1) Para / For / Pour / Für ref. P904.810 / P904.820 / P904.890
(2) Para / For / Pour / Für ref. P904.850



REF	mm	H mm	
P904.804 ¹	292 x 187	22	1
P904.809 ²	497 x 292	22	1

P904.801 Cubo base dispensador zumos /
Juice dispenser cube holder /
Cube base distributeur à jus /
Basisständer für Saftspender

Superficie superior de Abedúl finlandés /
Upper surface of finnish birch /
Surface supérieure en bouleau finlandais /
Oberfläche Finnischer Birke.



REF	mm	H mm	
P904.801	230 x 230	215	1

P904.806 Soporte y rejilla dispensador de zumos /
Base and grid for water drain /
Base et grille pour distributeur à jus /
Basis und Gitter für Saftspender



Superficie superior de Abedúl finlandés /
Upper surface of finnish birch /
Surface supérieure en bouleau finlandais /
Oberfläche Finnischer Birke.

REF	mm	H mm	
P904.806	230 x 190	20	1

CUBIC®

COLD

CARRO BUFFET CON POSIBILIDAD DE CONVERTIR EL CARRO EXPOSITOR EN MESA DE PRESENTACIÓN /
BUFFET TROLLEY WITH POSSIBLE TRANSFORMATION FROM AN EXPOSITOR TROLLEY TO A PRESENTATION TABLE /
CHARIOT BUFFET AVEC POSSIBILITÉ DE CONVERTIR LE CHARIOT D'EXPOSITION EN UNE TABLE DE PRÉSENTATION /
BUFFETSERVIERWAGEN MIT DER MÖGLICHKEIT DIESEN IN EINEN PRÄSENTATIONSTISCH UMZUWANDELN

P90490 Carro buffet negro 4 GN 1/1 / Black buffet trolley for 4 1/1 GN inserts / Chariot buffet noir pour 4 bacs GN 1/1 / Schwarzer Buffetservierwagen 4 GN 1/1

Madera con tratamiento hidrófugo especial,
de fácil limpieza /
Wood with special waterproof treatment,
easy to clean /
Bois avec un traitement hydrofuge
spécial, facile à nettoyer /
Holz mit spezieller wasserabweisender
Behandlung, einfach zu reinigen

Adaptado a medidas gastronorm /
Suitable for gastronorm sizes /
Adapté aux mesures gastronorme /
Geeignet für gastronormgrößen

EXCLUSIVE



*Dos tapas incluidas en precio /
*Two cover are included on the price /
*Deux tablettes comprises dans le prix /
*Zwei Deckel im Preis inklusive

REF. P90.492



900 mm

Tapa individual encaje GN 1/1 no incluida en precio /
Cover for 1/1 GN insert not included on the price /
Tablette de bac GN 1/1 non comprise dans le prix /
Individueller Deckel passend zu GN 1/1 nicht im
Preis inklusive
REF. P90493

Barra refuerzo nivel inferior /
Reinforcement bar /
Barre de renforcement /
Bewehrungsstab

Elegante combinación de madera
y aluminio /
Outstanding combination of wood
and aluminium /
Combinaison élégante en bois et
en aluminium /
Elegante Kombination aus Holz
und Aluminium

Ruedas giratorias e insonoras de
Ø 125 mm, con freno /
Soundproof and revolving castors
Ø 125 mm, with brakes /
Roulettes insonores et pivotantes de
Ø 125 mm, avec freins /
Bewegliche und geräuschlose räder
Ø 125 mm, mit bremsen

Se suministran desmontados
entre 3 a 5 minutos de montaje /
Delivered flatpacked between
3 to 5 minutes assembly /
Livrés démontés entre 3 et 5
minutes de montage /
Lieferung unmontiert räder
montage zwischen 3 und 5 minuten



REF	TIPO / TYPE	
P90.490*	4 X GN 1/1	1
P90.492	TAPA / COVER / TABLETTE / DECKEL	1
P90.493	TAPA / COVER / TABLETTE / DECKEL 1/1	1

WARM

**CARRO BUFFET ESPECIAL PARA TODO TIPO DE COMIDAS, FRÍAS, SEMI-FRÍAS O CALIENTES /
BUFFET TROLLEY SUITABLE FOR ALL KINDS OF FOOD, COLD, SEMI-COLD OR HOT /
CHARIOT BUFFET SPÉCIAL POUR TOUT TYPE DE NOURRITURES, FROIDES, SEMI-FROIDES OU CHAUDES /
BUFFETWAGEN GEIGNET FÜR ALLE MAHLZEITEN, KALT, WARM ODER GEMISCHT**

P90495 Carro buffet 4 1/1 GN caliente / Buffet trolley 4 1/1 GN hot /
Chariot buffet 4 1/1 GN chaud / Buffetwagen (warm) 4 1/1 GN

Superficie superior de abedul finlandés de altísima resistencia a ambientes húmedos e incluso a la intemperie /

Upper surface of Finnish birch, extremely resistant to humid environments and even outdoors /

Surface supérieure en bouleau finlandais, hautement résistante aux environnements humides et même aux intempéries /

Oberfläche Finnischer Birke, extrem widerstandsfähig gegen Feuchte und sogar im Freien

Adaptado a medidas gastronorm /
Suitable for gastronorm sizes /
Adapté aux mesures gastronorme /
Geignet für GastronormGrößen

EXCLUSIVE

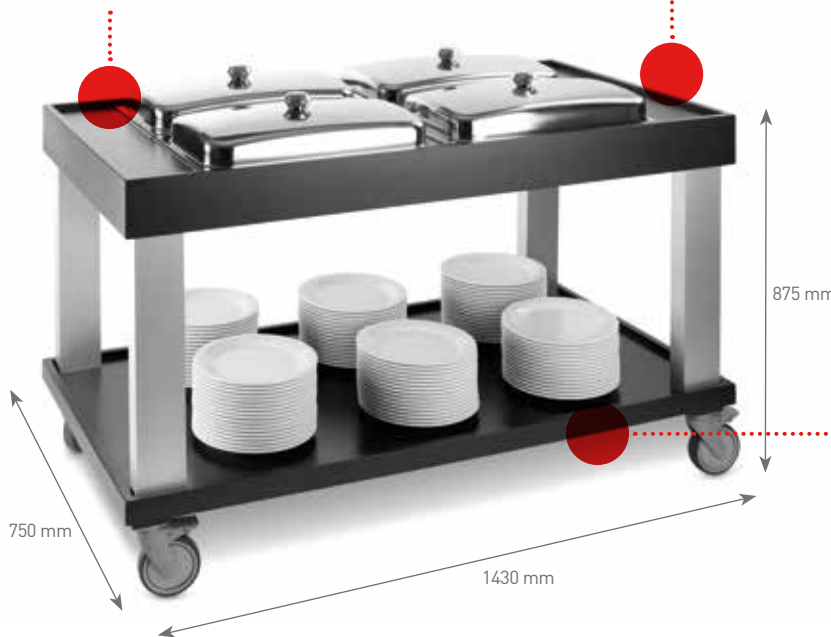

Opcional: se pueden adaptar placas de inducción /
Optional: can be adapted for induction plates /
Optionnel : on peut adapter des plaques à induction /
Zusatzausstattung: Passende Induktionsplatten verfügbar

Barra refuerzo nivel inferior /
Reinforcement bar /
Barre de renforcement /
Bewehrungsstab

*Se entrega con: 2 Elementos eléctricos Ref. 9500 + 4 cubetas GN 1/1 100 mm con soporte elemento eléctrico + 4 Tapas GN 1/1 + 2 Tapas madera /

*Comes with: 2 Electrical elements Ref. 9500 + 4 trays GN 1/1 100 mm with support electric element + 4 Covers GN 1/1 + 2 Wooden covers /

*Fourni avec : 2 éléments électriques Réf. 9500 + 4 bacs GN 1/1 100 mm avec support élément électrique + 4 couvercles GN 1/1 + 2 couvercles bois /

*Im Lieferumfang enthalten: 2 elektrische Elemente Ref. 9500 + 4 Speisebehälter GN 1/1 100 mm mit elektrischem Anschluss + 4 Deckel GN 1/1 + 2 Deckel, Holz

Instalación eléctrica preparada para 4 elementos eléctricos /

Electrical system designed for 4 electrical elements /

Installation électrique prévue pour 4 éléments électriques /

Elektrische Installation vorbereitet für vier elektrische Elemente

Lateral con soporte especial para tapas chafing dish /

Side with special support for chafing dish covers /

Partie latérale avec support spécial pour couvercles chafing dish /

Seitenelemente mit Halterung für Deckel des Chafing-Dish



REF	TIPO / TYPE	W max.	📦
P90.495*	4 x GN 1/1	3.500	1
P90.492	TAPA / COVER / TABLETTE / DECKEL		1
P90.493	TAPA / COVER / TABLETTE / DECKEL 1/1		1

TREND

**Carro madera-aluminio 2 estanterías / Wooden-aluminium trolley 2 shelves /
Chariot en bois-aluminium 2 plateaux / Servierwagen Holz-Aluminium mit 2 Regalen**

REF	COLOUR	
P80.210	BLANCO / WHITE / BLANC / WEISS	1
P80.220	NEGRO / BLACK / NOIR / SCHWARZ	1

Tratamiento hidrófugo.
Waterproof treatment.
Traitement hydrofuge.
Wasserabweisender Behandlung.



P80219 **Gueridón o carro auxiliar madera /
Wooden gueridon trolley /
Chariot guéridon en bois /
Abräum- oder Hilfswagen aus Holz**

Tratamiento hidrófugo / Waterproof treatment.
Traitement hydrofuge / Wasserabweisender Behandlung.



P80216 **Carro gueridón melamina roble /
Oak melamine gueridon trolley /
Chariot guéridon mélamine roure /
Servierwagen aus eiche melamine**

EXCLUSIVE







REF	COLOUR	
P80.219	NEGRO / BLACK / NOIR / SCHWARZ	1

REF	
P80.216	1

P90813 Carro porta-cubiertos / Cutlery dispenser trolley /
Chariot porte couverts / Transportwagen für besteck

EXCLUSIVE



REF			
P90.8132			1
P90.813			1



No incluye porta-cubiertos, cubetas GN, platos ni bandejas /
Trays, dishes, GN containers and cutlery dispenser not included /
Ramasse-couverts, bacs GN, assiettes, et plateaux pas compris /
Besteckbehälter, GN behälter, platten und tablett nicht inklusive

P90814 Porta-cubiertos / Cutlery bin /
Ramasse-couverts / Besteckbehälter

EXCLUSIVE

REF	mm		
P90.8142	710 x 335 x 155		1
P90.814	710 x 335 x 155		1

4 x 1/3 GN
H max. 100 mm



No incluye cubetas GN /
GN containers not included /
Bacs GN non inclus /
GN behälter nicht inklusive

PRESENTACIÓN Y EXPOSITORES / PRESENTATION AND DISPLAY / PRÉSENTATION ET PRÉSENTOIRS / PRÄSENTATION UND DISPLAY



**BUF
FET**



NATURAL
FIBERS

COMPATIBLE CON / SUITABLE FOR / ADAPTABLE POUR / GEEIGNET FÜR



Dos posiciones: derecho y revés.
Two positions: right and reverse.
Deux positions: droit et envers
Zwei Positionen: rechts und
rückwärts.



P. 391



P. 392



P. 397



P. 455

P59511 Caja GN bambú buffet / GN buffet bamboo box / Présentoir GN buffet bambou / Buffet GN-Bambusbox

1/1



REF	Mod	H cm	
P595.110	1/1	10	1
P595.111	1/1	20	1

P59512 Caja GN bambú buffet / GN buffet bamboo box / Présentoir GN buffet bambou / Buffet GN-Bambusbox

1/2



REF	Mod	H cm	
P595.120	1/2	10	1
P595.121	1/2	20	1

P59513 Caja GN bambú buffet / GN buffet bamboo box / Présentoir GN buffet bambou / Buffet GN-Bambusbox

1/3



REF	Mod	H cm	
P595.130	1/3	10	1
P595.131	1/3	20	1

P59510 Bandeja - Tapa para caja GN bambú buffet / Tray - Lid for GN buffet bamboo box /
Plateau - Couvercle pour présentoir GN buffet bambou / Abdeckung - Tablett für Buffet GN-Bambusbox



REF	Mod	H cm	
P595.100	1/1	2	1
P595.200	1/2	2	1
P595.300	1/3	2	1

**SOPORTES PRESENTACIÓN /
DISPLAY STANDS /
SUPPORT PRÉSENTATION /
HALTERUNG PRÄSENTATION**

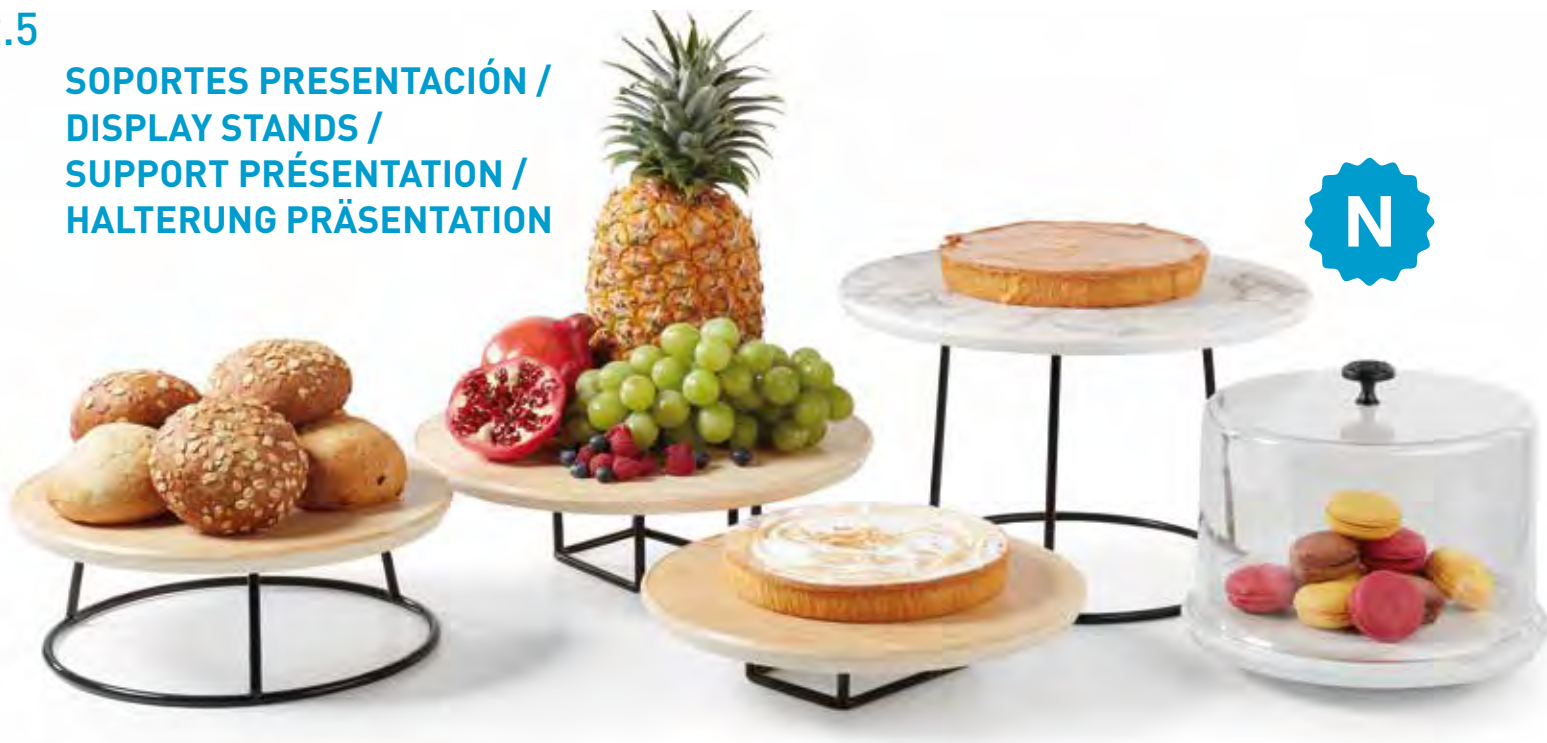

P59711 Expositor buffet / Buffet displayer / Présentoir buffet / Buffetständer

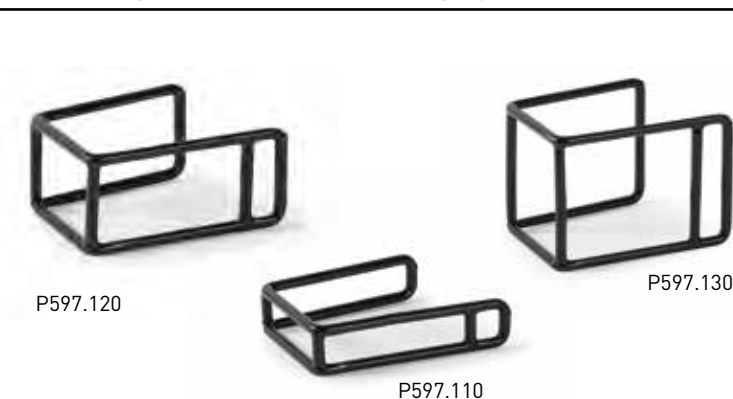

REF	L cm	H mm	
P597.110	12,5 x 10,5	3,0	1
P597.120	12,5 x 10,5	6,0	1
P597.130	12,5 x 10,5	9,0	1

P597170 Expositor buffet extensible / Retractable display stand /
Présentoir buffet rétractable / Rechteckiger Buffetständer

GN
1/1
1/2
1/3



REF	Max cm	Min cm	H mm Min / Max	
P597.170	530 x 325	325 x 176	65 / 100	1



Adaptable a cubetas GN.
Adjustable to GN container.
Adapté à bacs GN.
Passend für GN Behälter

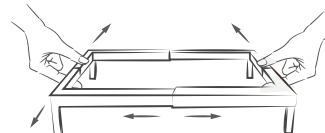

Max. GN 1/1



GN 1/2



Min. GN 1/3



P59714 Expositor buffet / Buffet displayer / Présentoir buffet / Buffetständer

	REF	Ø A cm	Ø B cm	H mm	
P597.140		25	21	10	1
P597.150		25	21	20	1
P597.160		25	21	30	1

P597.150	P597.160	P597.140	Ø B cm
			Ø A cm

VER PRODUCTOS EN / SEE PRODUCTS ON / VOIR PRODUITS EN PAGE / SIEHE PRODUKTE IN

BOL REDONDO /
ROUND BOWL /
BOL ROND /
RUNDE SCHÜSSEL



P. 381

VER PRODUCTOS EN / SEE PRODUCTS ON / VOIR PRODUITS EN PAGE / SIEHE PRODUKTE IN

SOPORTE PRESENTACIÓN /
DISPLAY PLATE /
PRÉSENTOIR /
PRÄSENTATIONSPLATTE



P. 390, 393



BUF
FET



P596110 Cesta rejilla GN negra / Black GN wire basket / Pannier metalique GN noir / Schwarzer GN Grillkorb



1/1



REF	Mod	L cm	H cm	
P596.110	1/1	52 x 31,5	12	6
P596.111	1/1	52 x 31,5	16	6

P596120 Cesta rejilla GN negra / Black GN wire basket / Pannier metalique GN noir / Schwarzer GN Grillkorb



1/2



REF	Mod	L cm	H cm	
P596.120	1/2	31,5 x 25,5	12	6
P596.121	1/2	31,5 x 25,5	16	6

P596130 Cesta rejilla GN negra / Black GN wire basket / Pannier metalique GN noir / Schwarzer GN Grillkorb



1/3



REF	Mod	L cm	H cm	
P596.130	1/3	31,5 x 17	12	6
P596.131	1/3	31,5 x 17	16	6

COMPATIBLE CON / SUITABLE FOR / ADAPTABLE POUR / GEEIGNET FÜR



P. 392



P. 393



P. 391



P. 449

46009

**Juego 3 expositores ángulos redondos / Set of 3 Square Bent Risers /
Jeu de 3 socles carrés aux angles arrondis / Set mit 3 quadratischen, gebogenen Ständern**

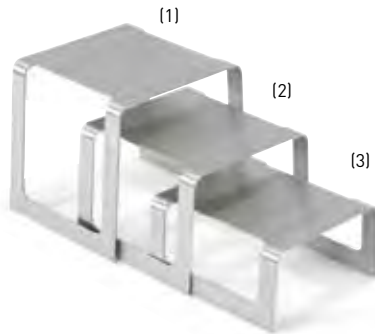

REF	mm	H mm	
46009	(1) 203 x 203	203	1
	(2) 203 x 191	152	
	(3) 203 x 178	102	

Acero inoxidable pulido / Brushed Stainless Steel /
Inox brossé / Gebürsteter Edel

4600960

**Juego 3 expositores ángulos redondos / Set of 3 Square Bent Risers /
Jeu de 3 socles carrés aux angles arrondis / Set mit 3 quadratischen, gebogenen Ständern**

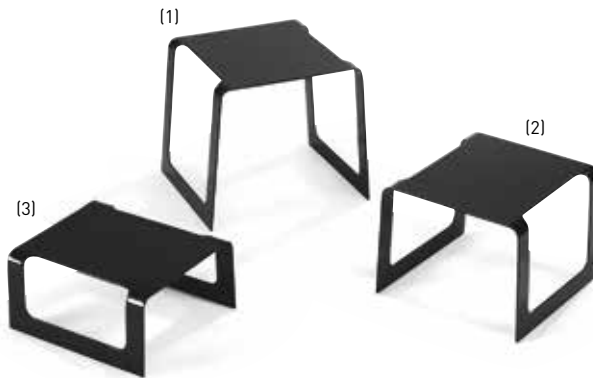

REF	mm	H mm	
4600960	(1) 203 x 203	203	1
	(2) 203 x 191	152	
	(3) 203 x 178	102	

Acero inoxidable / St/Steel /
Acier inoxydable / Rostfreier stahl

Negro / Black / Noir / Schwarz

19196 / 19184

**Placa adaptadora angular / Angled Adaptor Plate /
Plaque intermédiaire inclinée / Gewinkelte Adapterplatte**



19184

REF	cm	TIPO / TYPE	
19196	53 x 32,5 x 7,0	1 GN 1/1 (6°)	2
19184	53 x 32,5 x 5,5	2 GN 1/2 (8,2°)	1

Eleva las cubetas para mejorar la presentación de los alimentos /
Elevates pans to enhance food presentation /
Élévage des bacs pour améliorer la présentation des aliments /
Erhöhte Pfannen zur Verbesserung der Lebensmittelpräsentation



19196



19184

VER PRODUCTOS EN / SEE PRODUCTS ON / VOIR PRODUITS EN PAGE / SIEHE PRODUKTE IN

EXPOSITOR BUFFET /
BUFFET DISPLAYER /
PRÉSENTOIR BUFFET /
BUFFETSTÄNDER

GN
1/1
1/2
1/3
1/6



P. 399

P590.001 Vitrina rectangular / Rectangular display cabinet /
Vitrine rectangulaire / Auslagevitrine, rechteckige

REF	cm	H cm	BASE ÚTIL / FUNCTIONAL BASIC / BASE UTILE / NÜTZLICHE GRUNDAUSRÜSTUNG cm	
P590.001	40 x 24,5	15,5	34 x 19	1
P590.002	50,5 x 30,5	18,0	44 x 24,5	1

Plástico / Plastic / Plastique / Plastik

P590.003 Vitrina doble / Double display cabinet / Vitrine double / Doppel-Auslagevitrine

REF	cm	H cm	BASE ÚTIL / FUNCTIONAL BASIC / BASE UTILE / NÜTZLICHE GRUNDAUSRÜSTUNG cm	
P590.003	40 x 24,5	32	2 x (34 x 19)	1
P590.004	50,5 x 30,5	40	2 x (44 x 24,5)	1

Plástico / Plastic / Plastique / Plastik

P590.005 Vitrina redonda / Round display cabinet / Vitrine ronde / Auslagevitrine, rund

REF	cm	H cm	BASE ÚTIL / FUNCTIONAL BASIC / BASE UTILE / NÜTZLICHE GRUNDAUSRÜSTUNG cm	
P590.005	38	22	Ø 31,5	1
P590.006	46	26	Ø 37,5	1

Plástico / Plastic / Plastique / Plastik

SBC1014 Expositor pastelería 2 niveles / Bakery show case 2 levels /
Présentoir pâtisserie 2 niv. / Backwarenständler 2 Ebenen

REF	mm	H mm	
SBC1014-2F-06	370 x 370	400	1

Puertas frontales.
Incluye 2 bandejas negras de 25,5 x 35,5 cm.Front doors.
Includes two black trays: 25,5 x 35,5 cmPortes avant.
2 plateaux noirs de 25,5 x 35,5 cm inclus.Fronttüren.
Inklusive 2 Tablett schwarz 25,5 x 35,5 cm**LBC1418** Expositor pastelería 3 niveles / Bakery show case 3 levels /
Présentoir pâtisserie 3 niv. / Backwarenständler 3 Ebenen

REF	mm	H mm	
LBC1418-3F-06	470 x 500	560	1

Puertas frontales.
Incluye 3 bandejas negras de 35,5 x 45,5 cm.Front doors.
Includes three black trays: 35,5 x 45,5 cmPortes avant.
3 plateaux noirs de 35,5 x 45,5 cm inclusFronttüren.
Inklusive 3 Tablett schwarz 35,5 x 45,5 cm

P598 Tapa redonda transparente presentación / Clear round lid for presentation /
Couvercle rond transparent pour présentation / Transparent Präsentationsdeckel



REF	Ø cm	H cm	
P598.700	22	13,5	1
P598.800	27	16,5	1

P904.300 Tapa roll-top / Roll-top lid / Couvercle roll-top / Rolldeckel

1/1



REF	Mod	mm	H mm	
P904.300	1/1	570 x 325	175	1

P590110 Tapas GN transparentes presentación / Clear GN lids for presentation /
Couvercles GN transparents de présentation / Transparente GN-Präsentationsdeckel

1/1 1/2 1/3 2/4



REF	Mod	H cm	
P590.110	1/1	10	6
P590.120	1/2	10	12
P590.130	1/3	10	18
P590.240	2/4	10	12

Policarbonato.
Polycarbonate.
Polycarbonate.
Polycarbonat.

2/4

COMPATIBLE CON /
SUITABLE FOR /
ADAPTABLE POUR /
GEEIGNET FÜR



P834 Tapa rectangular GN de policarbonato /
GN polycarbonate rectangular lid /
Couvercle rectangulaire GN en polycarbonate /
Rechteckiger GN Deckel Polycarbonat

1/1



REF	Mod.	mm	H mm	
P834.000	1/1	530 x 325	100,0	1

P835 Campana GN de policarbonato /
GN polycarbonate dome lid /
Dôme de protection GN en polycarbonate /
GN Haube Polycarbonat

1/1



REF	Mod.	mm	H mm	
P835.000	1/1	530 x 325	190,0	1

BUFFET

Intrigue™

CHAFERS DE INDUCCIÓN /
INDUCTION CHAFERS /
CHAFERS POUR PLAQUE INDUCTION /
INDUKTIONS-RECHAUDS

Un elegante y versátil chafer con un diseño de perfil bajo para una mejor presentación /

An elegant yet versatile chafer with a low profile design for the best food presentation /

Un chafer élégant à la fois polyvalent et discret pour la meilleure présentation des plats /

Eleganter und zugleich vielseitiger Rechaud in schlichtem Design für die niveauvolle Präsentation von Speisen.



ESPAÑOL

Apto para inducción.

Modelo con parte superior de vidrio que permite ver la comida sin abrir el chafer – manteniendo la calidad del alimento.

Tapa removible con bisagra de cierre lento. Tres ángulos de apertura, cerrada, 45° ó 90°.

Soporte reforzado con piés antideslizantes que permite una mayor estabilidad.

La tapa y cubeta con sistema anti-goteo mantienen la condensación fuera del alimento.

Se presenta con cubetas de acero inoxidable brillante o de porcelana.

ENGLISH

Induction ready.

Glass top version allows viewing of food without opening chafer – maintaining food quality.

Removable cover with baffle, "stay put" hinge design holds cover in closed, 45° or 90° position.

Reinforced bracket with rubber table feet for longer life and to keep chafer in place.

Dripless cover and pans keep condensation off of food and tabletop.

Available with mirror-finished stainless steel or porcelain food pans.

FRANÇAIS

Compatible avec les plaques à induction.

Le modèle muni d'un couvercle en verre permet de voir le contenu sans ouvrir le chafer – tout en préservant la qualité des aliments.

Couvercle amovible équipé d'un déflecteur et d'une charnière bloquante qui permet de maintenir le couvercle fermé, à 45° ou à 90°.

Support renforcé avec des pieds de table en caoutchouc afin d'offrir une durée de vie plus longue et un meilleur maintien des chafers.

Le couvercle antigouttes et les bacs empêchent la condensation des aliments et de la table.

Disponibles avec bac à aliments en inox ultra-brillant ou en porcelaine.

DEUTSCH

Induktion-geeignet.

Die Version mit Glashaube ermöglicht den Blick auf die Speisen ohne den Rechaud zu öffnen und bewahrt so ihre Qualität.

Die zurück-klappbare Haube mit gedämpftem Haltescharnier hält die Haube geschlossen oder im 45° oder 90° Winkel geöffnet.

Die verstärkte Basis mit Gummifüßen sorgt dafür, dass der Rechaud lange einsetzbar und standfest bleibt.

Die tropffreie Haube und tropffreien Wannen halten Kondenswasser von Speisen und Tischen fern.

Erhältlich mit Wannen aus hochglanzpoliertem Edelstahl oder Porzellan.

46125 Chafing dish redondo con tapa cristal / Glass top S/S chafer with S/S trim /
 Chafer inox à couvercle en verre / Edelstahl-Chafer mit Glasdeckel, Details und Schüssel in Edelstahl



REF		mm	L	
46125	Fuente acero inox. S/S food pan Bac gastr. inox Edelstahlschüssel	394 x 80	5,8	1

46130 Fuente interior redonda / Food pan / Bac à aliments / Geflieste Schüssel



REF		mm	L	
46130	Porcelana Porcelain Porcelaine Porzellan	395 x 71	4,0	1
49130	Porcelana div. Divided porcelain Porcelaine Porzellan	395 x 71	3,5	1
46131	Acero inoxidable S/S Acier inoxydable Edelstahl	394 x 70	5,6	1

46134 Chafing dish cuadrado con tapa cristal / Glass top S/S chafer with S/S trim /
 Chafer inox à couvercle en verre / Edelstahl-Chafer mit Glasdeckel, Details und Schüssel in Edelstahl



REF		mm	L	
46134	Fuente acero inox. S/S food pan Bac gastr. inox Edelstahlschüssel	392 x 176 x 412	5,8	1
46135	Fuente porcelana Porcelain food pan Bac gastr. porcel. Porzellanschüssel	392 x 176 x 412	5,8	1

46136 Fuente interior cuadrada / Food pan / Bac à aliments / Geflieste Schüssel



REF		mm	L	
46136	Porcelana Porcelain Porcelaine Porzellan	392 x 52 x 388	3,5	1
49136	Porcelana div. Divided porcelain Porcelaine Porzellan	392 x 52 x 388	3,5	1
46137	Acero inoxidable S/S Acier inoxydable Edelstahl	392 x 71 x 392	6,3	1



ESPAÑOL

CHAFERS RETRÁCTILES

Acero inoxidable 18-8 brillante. Patas robustas y sólidas. Los chafers cuentan con una tapa acanalada que transfiere la condensación al interior de la cubeta del baño maría. Incluye protecciones contra el viento. El diseño de tapa con bisagras que permite tres opciones de apertura: cerrada, 90° y totalmente abierta. La tapa removible para facilitar su limpieza.

ENGLISH

RETRACTABLE CHAFERS

Mirror-finished, 18-8 stainless steel. Durable solid legs and welded construction. Chafers feature channeled cover that transfers condensation into the water pan. Includes windguards. Cover hinge design enables three cover positions - closed, 90° and fully open. Cover removes for easy cleaning.

FRAÇAIS

CHAFERS RÉTRACTABLES

Acier inoxydable 18-8 ultra-brillant. Pieds pleins soudés et de fabrication robuste. Les chafers disposent d'un couvercle à gorge qui transfère la condensation dans le bac à eau. Inclus une protection contre le vent. Le design de la charnière permet trois positions - couvercle fermé, à 90° et totalement ouvert. Couvercle amovible qui facilite le nettoyage.

DEUTSCH

RECHAUDS MIT ROLLDECKEL

Hochglanzpoliert, 18-8 Edelstahl. Strapazierbare robuste StandfüÙe und verschweißte Struktur. Die Rechauds sind mit einer gerillten Haube ausgestattet, die Kondenswasser in die Wasserwanne ableitet. Mit Windschutzvorrichtungen. Die Haubenscharniere ermöglichen drei Stellungen - geschlossen, 90° und vollständig geöffnet. Die Haube kann zur müheloseren Reinigung abgenommen werden.

46080 Chafing rectangular de sobremesa / Countertop rectangular chafer / Chafer rectangulaire de comptoir / Rechteckiger Chafer für Arbeitsflächen

ESTÁNDAR /
 STANDARD



REF	mm	L	PARA FOR	
46080	648 x 470 x 470	8,6	30022	1

Con fuente de baño maría estándar y tapa con obertura hasta 90° /

With standard water pan, dome cover only opens to 90° /
 Chafer rectangulaire 8,5 litres grande taille avec bac à eau standard, couvercle dôme s'ouvrant à 90° seulement /
 Rechteckiger Chafer 8,6 l komplett einziehbar mit Standardwanne ohne Tropfen mit Haubendeckel, der sich bis 90° öffnet.

46070 Chafing redondo de sobremesa / Countertop round chafer / Chafer rond de comptoir / Runder Chafer für Arbeitsflächen

ESTÁNDAR /
 STANDARD



REF	mm	L	PARA FOR	
46070	470 x 457 x 476	5,7	46862	1

Con fuente de baño maría estándar y tapa con obertura hasta 90° /

With standard water pan, dome cover only opens to 90° /
 Chafer rectangulaire 8,5 litres grande taille avec bac à eau standard, couvercle dôme s'ouvrant à 90° seulement /
 Rechteckiger Chafer 8,6 l komplett einziehbar mit Standardwanne ohne Tropfen mit Haubendeckel, der sich bis 90° öffnet.

46268 Chafing redondo empotrable / Drop-in round chafer /
 Chafer rond encastrable / Eingebauter, runder Chafer

RETRÁCTIL /
 RETRACTABLE /
 RÉTRACTABLE /
 RECHTECKIGER



REF	mm	L	PARA FOR	
46268	482,6 x 482,6 x 209,6	5,7	46862	1



Con fuente de baño maria sin goteo y tapa de cúpula de 3 posiciones / Fully retractable with food pan, dripless water pan, 3-position dome cover / Rectangulaire 5,7 litres avec bac à eau rectangulaire antigouttes et couvercle dôme / Rund, 5,7 l mit Wanne ohne Tropfen mit Haubendeckel.

46093

Dispensador de café / Coffee urn /
 Percolateurs / Kaffeurne



REF	mm	L	PARA FOR	
46093	324 x 330 x 502	11,4	-	1
46094	394 x 419 x 552	18,9	-	1

46090

Dispensador de sopa / Soup chafer /
 Chafer à soupe 7 qt / Suppen-Rechaud



REF	mm	L	PARA FOR	
46090	324 x 260 x 502	6,6	46088	1

46095

Dispensador de salsas / Gravy/sauce chafer /
 Chafer à sauce / Soßen-Rechaud



REF	mm	L	PARA FOR	
46095	324 x 260 x 381	2,4	46104	1

46280

Dispensador de líquidos / Beverage dispenser /
 Chafer à sauce / Soßen-Rechaud



REF	mm	L	PARA FOR	
46280	533 x 203 x Ø279	7,6	-	1

Chafers serie estándar / Value chafers /
 Chafers série standard / Standard Rechauds

P3875 Chafing dish rectangular con tapa roll top / Rectangular chafing dish roll top lid /
 Chafing dish rectangulaire avec couvercle roll top / Rechteckiger Chafing dish mit Rolldeckel



REF	mm	L	
P387.500	740 x 450 x 410	9,0	1

Soporte, recipiente, cubeta, tapa y asas de chapa en acero inox. Con 2 quemadores.

Stand, water pan, insert, lid and St/Steel handles. With 2 burners.

Support, récipient, bac, couvercle et poignées en acier inox. Avec 2 brûleurs.

Ständer, Behälter, Wanne, Deckel und Griffe aus Edelstahlblech. Mit 2 Brennern.

P8975 Chafing dish redondo tapa roll top / Round chafing dish roll top lid /
 Chafing dish rond avec couvercle roll top / Runder Chafing dish mit Rolldeckel



REF	ØA mm	ØB mm	AL mm	
P897.500	Ø350	Ø515	485	1

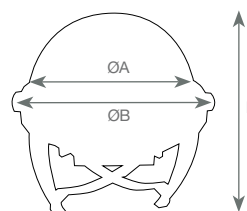

Apertura máxima: 180°.
 Max. opening: 180°.
 Ouverture maximale: 180°.
 Max. Öffnung: 180°.



Chafers serie económica / Economy chafers /
 Chafers série économique / Ökonomisch Rechauds

P379 Chafing dish con tapa / Chafing dish with lid / Chafing dish avec couvercle / Chafing dish mit Deckel



REF	mm	L	
P379.065	650 x 350 x 340	9,5	1

Soporte, recipiente, cubeta, tapa y asas de chapa en acero inox. Con 2 quemadores /
 Stand, water pan, insert, lid and St/Steel handles.
 With 2 burners /
 Support, récipient, bac, couvercle et poignées en acier inox.
 Avec 2 brûleurs /
 Ständer, Behälter, Wanne, Deckel und Griffe aus
 Edelstahlblech. Mit 2 Brennern.

P3795 Chafing dish económico con tapa / Economical chafing dish with lid /
 Chafing dish économique avec couvercle / Preiswerter Chafing Dish mit Deckel



REF	mm	L	
P379.500	650 x 350 x 320	9,0	1

Soporte, recipiente, cubeta, tapa y asas de chapa en acero inox. Con 2 quemadores /
 Stand, water pan, insert, lid and St/Steel handles.
 With 2 burners /
 Support, récipient, bac, couvercle et poignées en acier inox.
 Avec 2 brûleurs /
 Ständer, Behälter, Wanne, Deckel und Griffe aus
 Edelstahlblech. Mit 2 Brennern.

P387 Chafing dish con tapa tipo roll top / Chafing dish with roll top lid /
 Chafing dish avec couvercle "roll top" / Chafing Dish mit Roll-top Deckel



REF	mm	L	
P387.065	650 x 380 x 390	9,5	1

Soporte, recipiente, cubeta, tapa y asas de chapa en acero inox. Con 2 quemadores /
 Stand, water pan, insert, lid and St/Steel handles.
 With 2 burners /
 Support, récipient, bac, couvercle et poignées en acier inox.
 Avec 2 brûleurs /
 Ständer, Behälter, Wanne, Deckel und Griffe aus
 Edelstahlblech. Mit 2 Brennern.

12.6

CHAFINGS Y DISPENSADORES / CHAFERS & DISPENSERS / CHAFERS ET DISTRIBUTEURS / CHAFERS & SPENDER

Accesorios para chafers / Chafers accessories /
Accessoires pour chafers / Rechaud-zubehör



78710 Baño maría / Bain maries / Bain-marie / Wasseerbad



REF	Ø cm	H cm	L	
78710	10,5	14,5	1,20	6
78720	12,5	17,0	1,90	6
78725	15,5	10,0	1,90	6
78730	15,5	18,5	3,30	6
78740	16,5	19,5	4,00	6
78760	18,5	22,0	5,70	6

MB98719 Protección Anti-aliento / Mobile Breath Guards / Pare-haleine mobiles / Mobile Atemschutzplatten



REF	L cm		
MB98719	61	Cromo/Negro	1
MB98720	91	Cromo/Negro	1
MB98721	122	Cromo/Negro	1
MB98722	152	Cromo/Negro	1

Resistente base de acero con revestimiento pulvimetálico. Cristal acrílico curvado duradero. De fácil montaje. Se envían desmontadas.

Rugged steel base with powder coating. Curved acrylic glass which is durable and contemporary. Shipped knocked-down — easy to assemble.

Base en acier robuste avec revêtement en poudre. La vitre en acrylique incurvée est durable et contemporaine. Expédiés démontés — faciles à monter.

Widerstandsfähiger Stahlboden mit Beschichtung gebogenes, langlebiges und zeitgemäßes. Sie werden in Einzelteilen geliefert — sie sind einfach zu bestücken.



MBA92821 Protección acrílica Anti-aliento / Mobile Acrylic Breath Guards / Pare-haleine mobiles en acrylique / Mobile Acryl-Atemschutzplatten



REF	cm	
MBA92821	121,9 x 49,5 x 40,6	1

Solución para cubrir superficies de alimentos. Paneles acrílicos de 1 cm de grosor. Duradero. De fácil montaje y transporte.

Convenient, durable and portable solution to cover food serving areas. Folds down flat and secures with magnetic latches - for ease in transporting. 1 cm thick acrylic panels can be securely fastened in place with easy thumb turns.

Solution pratique, durable et portable pour couvrir les zones de service des aliments.

Praktische, haltbare und tragbare Lösung zur Abdeckung von Speisen-Servierbereichen.



P962 Calentador de platos o bandejas / Hot tray warmer / Réchaud / Tablett - oder Tellerwarmlhalter



REF	QUEMADORES / BURNERS / BRÛLEURS / BRENNER	mm	
P962.002	2	370 x 175 x 70	1
P962.003	3	430 x 175 x 70	1

Inox con placa base de aluminio. 2 ó 3 quemadores.
St/Steel with aluminium cover plate. 2 or 3 burners.
Inox avec plaque couvercle en aluminium. 2 ou 3 brûleurs.
Rostfreier Stahl mit Aluminium Basisplatte. 2 oder 3 Brenner.

P3871/P3872 Fuel para chafing dish / Chafing dish fuel / Fuel pour chafing dish / Brennstoff für chafing dish



REF	mm	DURACIÓN / LENGHT / DURÉE / DUAER	
P387.100	650 x 550	3 h	75
P387.200	830 x 600	6 h	60

Gracias a su fórmula especial no hay ninguna restricción especial por almacenaje o transporte. No gotea ni se derrama. No se evapora si se deja abierto. Puede guardarse si no se consume todo. No inflamable. No tóxico. Fácil de abrir y cerrar. La lata no se calienta. Fácil de encender una vez apagada.

Thanks to its special formula no storage or transport restriction are involved. Resealable. Non spill - Non drip. Non flammable. Non combustible. Non toxic fuel. Easy open & close. Container does not become hot to touch. Does not evaporate if left uncapped.

Grâce à sa formule spéciale il n'y pas de restriction pour le stockage et le transport. Hermétique. Non inflammable. Non combustible. Non toxique. Facile à ouvrir et fermer. On peut le garder si on ne le consomme pas tout. Facile à allumer une fois éteint.

Dank seiner speziellen Formel gibt es keinerlei spezielle Beschränkung für den Transport oder Lagerung. Wiederverschliessbar. Keine Verdampfung beim Auflassen. Wiederverwendbar bei nicht vollständigem Verbrauch. Nicht leicht entzündbar. Nicht giftig. Einfach zu öffnen und verschliessen. Die Dose erhitzt sich nicht. Einfach anzuzünden einmal ausgegangen.

P3722 Contenedor para combustible de chafing dish / Burner holder for chafing dish / Porte-brûleur pour chafing dish / Brennstoffbehälter für chafing dish



REF	
P372.200	1

Adaptable. REF:
P379, P387, P898, P8991

P685 Fuel para chafing dish / Chafing dish fuel barrel / Bidón fuel chafing dish / Brennstoff für chafing dish



REF	L	KG	
P685.004	5	5	1

ETANOL / ETHANOL

Sin hollín. Sin olor / No soot. No smell /
Pas de suie. Inodore / Kein Russ. Kein Gerusch.

VER PRODUCTOS EN / SEE PRODUCTS ON / VOIR PRODUITS EN PAGE / SIEHE PRODUKTE IN

ELEMENTO ELÉCTRICO PARA CHAFING DISH /
ELECTRIC HEATING UNIT FOR CHAFING DISH /
CORPS DE CHAUFFE POUR CHAFING DISH /
ELEKTRISCHES ELEMENT FÜR CHAFING DISH



P. 340

DISPENSADORES LÍQUIDOS Y CERALES / JUICE & CEREALS / DISTRIBUTEUR À JUS ET CÉRÉALES / SAFT- / FRÜHSTÜCKFLOCKENSPENDER



P8992 Dispensador de zumos - acero inox /
Juice dispenser St/Steel /
Distributeur à jus - acier inox /
Saftspender - Edelstahl



P899.200

P899.202

REF		L	
P899.200	Acero inox / St/Steel	8,0	1
P899.202	Acero inox / St/Steel	8,0 + 8,0	1

P8993 Dispensador de leche - acero inox /
St/Steel milk dispenser /
Distributeur à lait - acier inox /
Milchspender Edelstahl



P899.300

P899.302

REF		L	
P899.300	Acero inox / St/Steel	8,0	1
P899.302	Acero inox / St/Steel	8,0 + 8,0	1

4635210 Dispensador de cereales doble /
Double Cereal Dispenser /
Distributeur à céréales double /
Getreideflocken-Doppelbehälter



REF	mm	L (x2)	
4635210	310 x 220 x 600	3,8	1

T3660 Dispensador de cereales D-Lux /
D-Lux cereal dispenser /
Distributeur à céréales D-Lux /
D-Lux-Getreideflockenspender



REF	mm	L	
T3660	254 x 356 x 686	8,0	1

ESTACIONES CONTORNEADAS PARA BANQUETES / CONTOURED BUFFET STATIONS / STATIONS POUR BUFFET ARRONDIES / GEWELLTE BÜFFETSTATIONEN



Opción elegante y flexible para servir los alimentos calientes. Aluminio y acero cromado de alta calidad.

Stylish yet flexible option for hot food buffet serving. High quality and durable aluminium and chrome-plated steel.

Option élégante et flexible pour le service de buffets chauds. Aluminium et acier chromé robustes et de haute qualité.

Eine elegante und zugleich zuverlässige Option für das warme Büffet. Hochwertiges strapazierfähiges Aluminium und verchromter Stahl.

4667470 Estación buffet con rejilla / Buffet station with wire grill / Station pour buffet avec grille / Kleine Büffetstation mit Stabrost



*Bandeja no incluida /
*Griddle pan not included /
*Plaque non incluse /
*Grillpfanne nicht enthalten

REF	mm		
4667470*	406 x 406 x 191	Marrón/Brown	1
4667570	533 x 406 x 191	Marrón/Brown	1

4667670 Estación buffet para cocina inducción / Induction buffet station / Station pour buffet à induction / Induktionsbüffetstation



REF	mm		
4667670	502 x 438 x 191	Marrón/Brown	1

Placa inducción no incluida / Induction unit sold separately /
Plaque induction non incluse / Induktionsplatte nicht enthalten.



77540 Bandeja presentación estación buffet / Griddle pan / Plaque de grill / Griddle-Pfanne



REF	mm	PARA / FOR	
77540	443 x 406 x 37	4667470	1
77541	624 x 438 x 37	4667570	1



46575 Bol cónico doble pared /
Conical beehive bowls /
Bols double paroi évasée /
Konische doppelwandige Schale

NSF



REF	Ø mm	H mm	L	
46575	160	69	0,59	1
46576	200	88	1,30	1
46577	240	108	2,40	1

46584 Bol inclinado doble pared /
Angled beehive bowls /
Bols nid d'abeilles à paroi inclinée /
Angewinkelte Bienenstock-Schüsseln

NSF



REF	Ø mm	H mm	L	
46584	188	139	0,95	6
46585	240	173	1,7	6
46586	300	209	3,5	2
46582	350	239	4,7	2

47619 Bol estriado cuadrado doble pared /
Double-Wall Square Beehive Serving Bowls /
Bol lis carré double paroi /
Doppelwandige, quadratische, gerillte Schale

NSF



REF	mm	H mm	L	
47619	139 x 139	70	0,7	6
47632	185 x 185	89	1,7	12
47634	218 x 218	108	3,0	6
47635	244 x 244	131	4,9	4
47637	299 x 299	150	7,8	3

46587 Bol estridado redondo doble pared /
Beehive Style Double-Wall Serving Bowls /
Bol à bande rond double paroi /
Geriffelte, runde, doppelwandige Schüssel

NSF



Acero inoxidable brillante /
Mirror finished /
Polissage brillant /
Mirror finished

REF	Ø mm	H mm	L	
46587	144	76	0,7	6
46590	184	103	1,6	6
46591	241	129	3,2	6
46592	300	165	6,6	3
46569	350	175	9,6	2

46665 Bol redondo doble pared con aro brillante /
Beehive Style Double-Wall Serving Bowls /
Bol bande brillant rond double paroi /
Runde, doppelwandige Schale mit glänzendem Ring

NSF



Cuerpo pulido satinado. Borde superior pulido brillante /
Body mat finished. Rim mirror finished /
Finition corps satinée / Finition bande brillante /
Matte Lackierung aussen / Glänzende Lackierung am Rand

REF	Ø mm	H mm	L	
46665	144	76	0,7	6
46666	184	103	1,6	6
46667	241	129	3,2	6
46668	300	165	6,6	3
46669	350	175	9,6	2

82005 Tapa para bol redondo doble pared /
Covers for Double Wall Round Bowls /
Couvercles pour bols ronds à double paroi /
Deckel für runde, doppelwandige Schüsseln



Combinaciones de acabados satinados/brillantes /
Combination satin/mirror finish for beautiful food presentations /
Finition satinée/brillante mixte pour une belle présentation des plats /
Glänzende Lackierungskombination für eleganten Präsentation

REF	Para / For / Pour / Für	Ø mm	
82005	46587 & 46665	144	3
82006	46590 & 46666	184	10

BOLS SERVICIO DOBLE PARED/ DOUBLE WALL INSULATED SERVING BOWLS/ BOLS SERVICE DOUBLE PAROI ISOTHERMES/ DOPPELWANDIGE SCHALEN

CONSTRUCCIÓN AISLANTE DE PARED DOBLE QUE PERMITE CONSERVAR LA TEMPERATURA DE LOS ALIMENTOS, YA SEAN FRÍOS O CALIENTES/

DOUBLE WALL INSULATED SERVING BOWLS THAT ALLOWS KEEPING THE FOOD TEMPERATURE, WHETHER COLD OR HOT/

CONSTRUCTION D'ISOLATION À DOUBLE PAROI QUI PERMET DE MAINTENIR LA TEMPÉRATURE DE LA NOURRITURE, FROIDE OU CHAUDE/

DOPPELWANDIGE ISOLIERUNGSSCHALEN, DIE DIE TEMPERATUR DES LEBENSMITTELS HALTEN, SEI ES KALT ODER HEISS

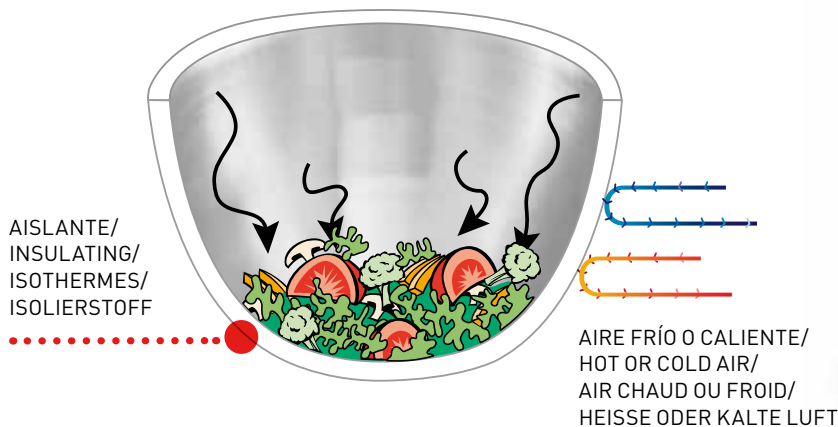

NO TRANSPIRAN. NO ES NECESARIO PRECALENTAR O ENFRIAR/
WILL NOT TRANSPIRE. REQUIRES NO PREHEATING OR CHILLING/
PAS DE CONDENSATION SUR LES PAROIS. N'EXIGE AUCUN PRÉCHAUFFAGE OU REFRROIDISSEMENT/
KEINE KONDENSATBILDUNG.ERFORDERT KEIN VORWÄRMEN ODER ABKÜHLEN

PAREDES AISLANTES QUE MANTIENEN LOS ALIMENTOS A LA TEMPERATURA DE SERVICIO/
INSULATING WALLS THAT KEEP FOOD AT SERVICE TEMPERATURE/
CONSTRUCTION ISOLANT QUI GARDE LES ALIMENTS À LA TEMPÉRATURE DE SERVICE/
DIE ISOLIERUNGSWÄNDE HALTEN DAS ESSEN AUF BETRIEBSTEMPERATUR.



LAVAR A MANO/
HAND WASHING/
LAVER À LA MAIN/
VON HAND WASCHEN

RETENCIÓN DEL FRÍO: BOLS
AISLANTES DE DOBLE PARED
Protocolo de prueba, 2004

COLD RETENTION: DOUBLE
WALL INSULATED BOWLS
Test protocol, 2004

RÉTENTION DU FROIDE:
CONSTRUCTION D'ISOLATION
À DOUBLE PAROI
Protocolo de prueba, 2004

KÄLTESPEICHERUNG:
DOPPELWANDIGE ISOLIERTE
SCHALEN
Protocolo de prueba, 2004

TEMPERATURA/
TEMPERATURE/
TEMPÉRATURE/
TEMPERATUR
(Celsius/Fahrenheit)

— 46591 3.2 L
— 47652 3.5 L
— 46592 6.6 L

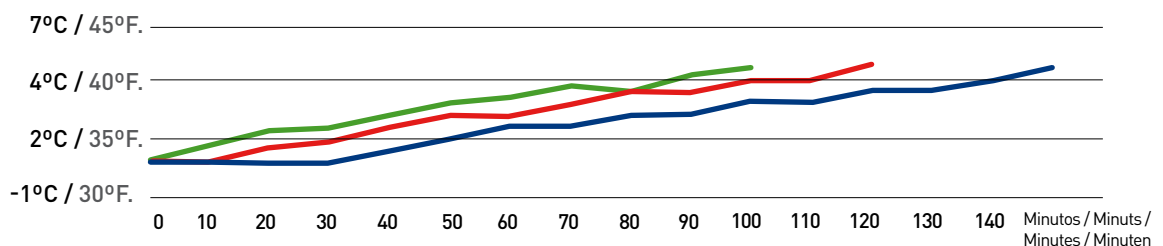

1) Se colocó ensalada de patatas en diversos bols, llenando $\frac{3}{4}$ de la capacidad del bol.
2) Temperatura inicial de la comida 0,6°C; temperatura ambiente 20,6°C.
3) Cada 10 minutos se registró la temperatura en el centro de la ensalada.
4) La prueba concluyó cuando la comida alcanzó una temperatura de 5°C.

1) Potato salad was placed in different bowls. Filling $\frac{3}{4}$ of the capacity of the bowl.
2) Initial temperature of the food 0,6°C; ambient temperature 20,6°C.
3) The temperature in the centre of the salad was recorded every 10 minutes.
4) The test concluded when the food reached a temperature of 5°C.

1) La salade de pommes de terre a été placée dans différents bols. Remplissage $\frac{3}{4}$ de la capacité du bol.
2) La température initiale de l'aliment 0,6°C; température ambiante 20,6°C.
3) La température au centre de la salade a été enregistrée toutes les 10 minutes.
4) Le test s'est terminé lorsque la nourriture a atteint une température de 5°C.

1) Kartoffelsalat wurde in verschiedene Schalen gegeben. Es wurden $\frac{3}{4}$ der Kapazität der Schüssel gefüllt.
2) Anfangstemperatur des Lebensmittels 0,6°C; Umgebungstemperatur 20,6°C.
3) Die Temperatur in der Mitte des Salats wurde alle 10 Minuten aufgezeichnet.
4) Der Test wurde abgeschlossen, als das Essen eine Temperatur von 5°C erreichte.

**Bol colores redondo doble pared /
Round Colored Double Wall Bowls /
46587 Bols ronds de service à double paroi isothermes en couleurs /
Runde Servierschalen, doppelwandig isoliert und farbig**

NSF



REF	Ø mm	H mm	L	
46587 + COLOR	114	76	0,7	6
46590 + COLOR	184	103	1,6	6
46591 + COLOR	241	129	3,2	6
46592 + COLOR	300	165	6,6	3
46569 + COLOR	350	175	9,6	2

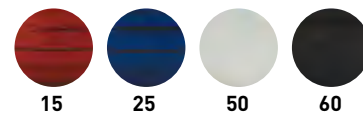

**Bol colores cuadrado doble pared /
Square Colored Double Wall Bowls /
47619 Bols carrés de service à double paroi isothermes en couleurs /
Runde Servierschalen, doppelwandig isoliert und farbig**

NSF



REF	mm	H mm	L	
47619 + COLOR	139 x 139	70	0,7	6
47632 + COLOR	184 x 184	87	1,7	12
47634 + COLOR	216 x 216	108	3,0	6
47635 + COLOR	258 x 258	130	4,9	4
47637 + COLOR	299 x 299	150	7,9	3

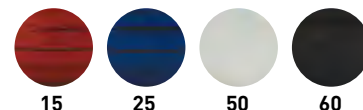

V I O L E T

C O L L E C T I O N



BUFFET ACCESSORIES /
BUFFET & ACCESSORIES /
BUFFET ET ACCESSOIRES

VER PRODUCTOS EN / SEE PRODUCTS ON / VOIR PRODUITS EN / SIEHE PRODUKTEN IN P. 106

ESPAÑOL

Borde con acabado satinado e interior brillante, creando una elegante contraste visual /

ENGLISH

Satin-finished rim and mirror-finished interior creates a visual contrast that accentuates the food product /

FRANÇAIS

Le rebord satiné et l'intérieur ultra-brillant crée un contraste visuel qui met en valeur les plats /

DEUTSCH

Rand mit satiniertem Finish und Innenseite glänzend, wodurch sich ein optischer Kontrast ergibt, der die Speisen hervorhebt.

82093 Bandeja servicio rectangular acero inoxidable / Rectangular Stainless Steel serving trays /
Plateau service rectangulaire / Rechteckiges Serviertablett

REF	mm	
82093	305 x 229	3
82094	457 x 254	3
82095	533 x 305	3

82090 Bandeja servicio cuadrada acero inoxidable / Square Stainless Steel serving trays /
Plateau service carré / Quadratisches Serviertablett

REF	mm	
82090	298 x 298	3
82091	400 x 400	3
82092	470 x 470	3

82060 Bandeja servicio oval acero inoxidable / Oval Stainless Steel serving trays /
Plateau service oval / Ovaes Serviertablett

REF	mm	
82060	375 x 276	3
82061	448 x 330	3
82062	537 x 394	3

P317 Fuente oval borde vuelto / Oval serving dish with rolled edge /
Plat ovale à bords ronds / Ovaes Serviertablett mit abgerundetem Rand

REF	cm	
P317.025	25 x 17,2	1
P317.030	30 x 20,2	1
P317.035	35 x 23,3	1
P317.040	40 x 26,7	1
P317.045	45 x 29,2	1
P317.050	50 x 31,2	1

Pulido satinado / Satin finished /
Polissage satiné / Satiniert poliert**P3174** Fuente oval borde vuelto económica / Economical oval serving dish with rolled edge /
Plat ovale à bords ronds économique / Ovaes ökonomisches Serviertablett mit abgerundetem Rand

REF	cm	
P317.425	25 x 17,5	1
P317.430	30 x 21,0	1
P317.435	35 x 24,0	1
P317.440	40 x 26,5	1
P317.445	45 x 29,5	1
P317.450	50 x 34,0	1

Pulido brillante / Mirror finished /
Polissage brillant / Satiniert poliert

P907 Sopera inox con base / St/Steel soup tureen with stand /
Soupière inox avec pied / Edelstahlsuppenschüssel mit Fuss



REF	Ø cm	L	
P907.024	24	2,50	1
P907.026	26	3,50	1

Pulido brillante / Mirror finished /
Polissage brillant / Satiniert poliert

P927 Ensaladera acrílica redonda / Acrylic round salad bowl /
Saladier rond acrylique / Runde Acrylsalatschüssel



REF	Ø mm	H mm	
P927.000	258 x 158	158	6

P928 Ensaladera acrílica cuadrada / Acrylic Squared salad bowl /
Saladier carré acrylique / Quadratische Acrylsalatschüssel



P928.000

P928.001

REF	mm	
P928.000	285 x 285 x 124	12
P928.001	147 x 147 x 70	24

P903 Placa enfriadora / Cooling plate / Plaque réfrigérante / Kälteplatte

INOX - ST/STEEL
EDELSTAHL
18/10



REF	TIPO/TYPE	mm	
P903.001	1/1	530 x 325	1
P903.002	1/2	325 x 265	1

Para una presentación fácil e higiénica de alimentos fríos en los buffets. En el congelador: Mínimo 4h por debajo de los -4 °C. Aguanta 5-6h con temperaturas por debajo de los 23 °C.

For an easy and hygienic presentation of cold food. Simple place in the freezer. Minimum 4 hour under -4°C. Tolerance under 23°C: 5-6h.

Pour une présentation hygienique et facile des aliments froids sur les buffets. Au congélateur. Minimum 4h à des températures inférieures à -4 °C. Résistance à des températures inférieures à 23 °C: 5-6h.

Für die einfache und hygienische Präsentation von kalten Lebensmittel auf den Buffets. Im Gefrierschrank: Mindestens 4h unter -4 °C. Hält 5-6h Temperaturen unter 23 °C stand.

V I O L E T
C O L L E C T I O N



VER PRODUCTOS EN / SEE PRODUCTS ON / VOIR PRODUITS EN / SIEHE PRODUKTEN IN P. 101 - 109





P361

Cacillo monobloc /
One piece ladle /
Louche monobloc /
Schöpflöffel Monoblock



REF	Ø cm	L cm	L	
P361.000	9	30	0,10	1

P362

Espumadera monobloc /
One piece skimmer /
Écumoire monobloc /
Schaumlöffel Monoblock



REF	Ø cm	L cm	L	
P362.000	11	33,5	10,40	1

P363

Espátula monobloc /
One piece turner /
Spatule monobloc /
Pfannenwender Monoblock



REF	L cm	
P363.000	32	1

P364

Cuchara de servicio monobloc /
One piece serving spoon /
Cuillère de service monobloc /
Servierlöffel Monoblock



REF	L cm	
P364.000	31	1

P365

Tenedor monobloc /
One piece fork /
Fourchette monobloc /
Fleischgabel Monoblock



REF	L cm	
P365.000	32	1

P366

Cacillo salsas monobloc /
One piece sauce ladle /
Cuillère à sauces monobloc /
Sossenlöffel Monoblock



REF	Ø cm	L cm	L	
P366.000	7	28	0,10	1

P367

Cuchara ensalada monobloc /
One piece salad spoon /
Cuillère à salade monobloc /
Salatlöffel Monoblock



REF	L cm	
P367.000	30	1

P368

Cuchillo cocina /
Carving knife /
Couteau à pâtisserie /
Küchenmesser



REF	L cm	
P368.000	28,5	1

P369

Pala pasteles /
Cake server /
Pelle à gâteau /
Keksschaufel



REF	L cm	
P369.000	22	1

P3611

Cacillo monobloc /
One piece ladle /
Louche monobloc /
Schöpflöffel Monoblock



Pulido brillante.
 Mirror polishing.
 Polissage brillant.
 Glänzend poliert.

REF	Ø cm	L cm	L	
P361.100	9,5	32	0,15	1

P3621

Espumadera monobloc /
One piece skimmer /
Écumoire monobloc /
Schaumlöffel Monoblock



Pulido brillante.
 Mirror polishing.
 Polissage brillant.
 Glänzend poliert.

REF	Ø cm	L cm	L	
P362.100	11	35	7,15	1

P3631

Espátula monobloc /
One piece turner /
Spatule monobloc /
Pfannenwender Monoblock



Pulido brillante.
 Mirror polishing.
 Polissage brillant.
 Glänzend poliert.

REF	L cm	
P363.100	37	1

P3641

Cuchara de servicio monobloc /
One piece serving spoon /
Cuillère de service monobloc /
Servierlöffel Monoblock



Pulido brillante.
 Mirror polishing.
 Polissage brillant.
 Glänzend poliert.

REF	L cm	
P364.100	34,5	1

P3651

Tenedor monobloc /
One piece fork /
Fourchette monobloc /
Fleischgabel Monoblock



Pulido brillante.
 Mirror polishing.
 Polissage brillant.
 Glänzend poliert.

REF	L cm	
P365.100	37	1

P3671

Cuchara para spaghetti /
Spaghetti server /
Cuillère à spaghetti /
Spaghettilöffel



Pulido brillante.
 Mirror polishing.
 Polissage brillant.
 Glänzend poliert.

REF	L cm	
P367.100	35	1

P3691

Pala pasteles /
Cake server /
Pelle à gâteau /
Keksschaufel



Pulido brillante.
 Mirror polishing.
 Polissage brillant.
 Glänzend poliert.

REF	L cm	
P369.100	31	1

VER PRODUCTOS EN / SEE PRODUCTS ON / VOIR PRODUITS EN PAGE / SIEHE PRODUKTE IN

MOLINILLOS PIMIENTA Y SAL. MADERA /
PEPPER MILL-SALT MILL. WOODEN /
MOULINS À POIVRE ET SEL. BOIS /
PFEFFER- UND SALZMÜHLEN. HOLZ



P. 502



P341 Cacillo monobloc. Acero inox 18% cr. /
One piece ladle. 18% cr. St/Steel /
Louche monobloc. inox 18% cr. /
Schöpflöffel Monoblock. Edelstahl 18 % Cr



Pulido satinado mate.
Mat satiny finished.
Poli satiné mat.
Matt satiniert poliert.

REF	Ø cm	L cm	L	
P341.000	8,5	28	0,10	12

P342 Espumadera monobloc. inox 18% cr. /
One piece skimmer. 18% cr. St/Steel /
Écumoire monobloc. inox 18% cr. /
Schaumlöffel Monoblock. Edelstahl 18 % Cr



Pulido satinado mate.
Mat satiny finished.
Poli satiné mat.
Matt satiniert poliert.

REF	Ø cm	L cm	
P342.000	11	33	12

P343 Espátula monobloc. inox 18% cr. /
One piece turner. 18% cr. St/Steel /
Spatule monobloc. inox 18% cr. /
Pfannenwender Monoblock. Edelstahl 18 % Cr



Pulido satinado mate.
Mat satiny finished.
Poli satiné mat.
Matt satiniert poliert.

REF	L cm	
P343.000	33	12

P344 Tenedor monobloc. inox 18% cr. /
One piece fork. 18% cr. St/Steel /
Fourchette monobloc. inox 18% cr. /
Fleischgabel Monoblock. Edelstahl 18 % Cr



Pulido satinado mate.
Mat satiny finished.
Poli satiné mat.
Matt satiniert poliert.

REF	L cm	
P344.000	30	12

P345 Cuchara monobloc. inox 18% cr. / One piece spoon. 18% cr. St/Steel
Cuillère monobloc. inox 18% cr. / Servieröffel Monoblock. Edelstahl 18 % Cr



Pulido satinado mate.
Mat satiny finished.
Poli satiné mat.
Matt satiniert poliert.

REF	L cm	
P345.000	34	12

48144 Cuchillo chuletero, mango plástico negro /
Steak knife black plastic handle /
Couteau Steak manche noir plastique /
Steakmesser, Kunststoffgriff, schwarz



Pack: 12 u.

REF	HOJA / BLADE / LAME / BLATT L cm	TOTAL L cm	
48144	12,4	25,1	12

48148 Cuchillo chuletero, mango plástico madera /
Steak knife riveted wooden handle /
Couteau Steak manche bois plastique /
Steakmesser, Kunststoff- / Holzgriff



Pack: 12 u.

REF	HOJA / BLADE / LAME / BLATT L cm	TOTAL L cm	
48148	12,7	25,1	12

12.10 UTENSILIOS DE SERVICIO / SERVING TOOLS / USTENSILES DE SERVICE BUFFET / SERVIERBESTECK

P33614 Pinza / Tong / Pince / Zange

-40°C +210°C

Inox + Nylon
St/Steel + Nylon
Rostfreier Stahl + Nylon



REF	L cm	
P33.614	34,5	12

P33601 Cacillo / Ladle / Louche / Schöpflöffel

-40°C +210°C

Inox + Nylon
St/Steel + Nylon
Rostfreier Stahl + Nylon



REF	L cm	Lts	
P33.601	32	0,08	12

P33602 Espumadera / Skimmer / Écumoire / Schaumlöffel

-40°C +210°C

Inox + Nylon
St/Steel + Nylon
Rostfreier Stahl + Nylon



REF	L cm	Lts	
P33.602	35	11,5	12

P33603 Cuchara de servicio / Serving spoon / Cuillère de service / Servierlöffel

-40°C +210°C

Inox + Nylon
St/Steel + Nylon
Rostfreier Stahl + Nylon



REF	L cm	
P33.603	34,5	12

P33604 Espátula / Turner / Spatule / Pfannenwender

-40°C +210°C

Inox + Nylon
St/Steel + Nylon
Rostfreier Stahl + Nylon



REF	L cm	
P33.604	35,5	12



P33621 Cacillo / Ladle / Louche / Schöpflöffel

-40°C +210°C

Nylon + Inox
Nylon + St/Steel
Nylon + Rostfreier Stahl



REF	L cm	Lts	
P33.621	35	0,08	1

P33622 Cuchara de servicio / Serving spoon / Cuillère de service / Servierlöffel

-40°C +210°C

Nylon + Inox
Nylon + St/Steel
Nylon + Rostfreier Stahl



REF	L cm	
P33.622	35	1

P33623 Cuchara perforada / Slotted spoon / Cuillère à fente / Perforiert Löffel

-40°C +210°C

Nylon + Inox
Nylon + St/Steel
Nylon + Rostfreier Stahl



REF	L cm	
P33.623	35	1

P33624 Espátula / Turner / Spatule / Pfannenwender

-40°C +210°C

Nylon + Inox
Nylon + St/Steel
Nylon + Rostfreier Stahl



REF	L cm	
P33.624	35	1

P33625 Cuchara para spaghetti / Spaghetti server / Cuillère à spaghetti / Spaghettilöffel

-40°C +210°C

Nylon + Inox
Nylon + St/Steel
Nylon + Rostfreier Stahl



REF	L cm	
P33.625	35	1



P33801

Cuchara de servicio de madera /
Wooden serving spoon /
Cuillère de service en bois /
Holz-Servierlöffel



REF	L cm	
P33.801	30,5	12

P33802

Cuchara perforada de madera /
Wooden slotted spoon /
Cuillère à fente en bois /
Perforierter Holzlöffel



REF	L cm	
P33.802	30,5	12

P33803

Espátula de madera /
Wooden turner /
Spatule en bois /
Holzwender



REF	L cm	
P33.803	30,5	12

P33804

Cuchara para spaghetti de madera /
Wooden spaghetti server /
Cuillère à spaghetti en bois /
Holz-Spaghettilöffel



REF	L cm	
P33.804	30,5	1

P33805

Tenedor de mesa de madera /
Wooden one piece fork /
Fourchette en bois /
Holz-Tafelgabel



REF	L cm	
P33.805	30,5	1

P33806

Pinza de servicio de madera /
Wooden serving tong /
Pince de service en bois /
Holz-Servierzange



REF	L cm	
P33.806	28	1

P33807

Pinza de pan de madera /
Wooden bread spoon /
Pince à pain en bois /
Holz-Brotzange



REF	L cm	
P33.807	25,5	1

P33808

Servidor de ensalada de madera /
Wooden salad hands /
Serveur salade en bois /
Holz-Salatbesteck



Pack: 12 u.

REF	L cm	
P33.808	17,5	1

P33809

Cuchillo de madera /
Wooden knife /
Couteau en bois /
Holzmesser



REF	L cm	
P33.809	17,5	1



P358 Pinza buffet BPA Free color / Coloured BPA Free utility tong /
Pince buffet SANS BPA en couleurs / Farbige BPA Free buffetzangen



REF	L cm	Transp. Clear	Blanco White Blanc Weiss	Rojo Red Rouge Rot	Negro Black Noir Schwarz	
P358	23	0	1	2	7	1

REF 358 + L + COLOR

46926 Pinza servicio / Serving tong /
Pince de service / Servierzange



REF	L cm	
46926	21	12

46938 Pinza buffet / Buffet tong /
Pince à buffet / Büffetzange



REF	L cm	
46938	30,5	6

P359 Pinza de servicio / Serving tong /
 Pince de service / Servierzange



REF	L cm	
P359.000	24	1

P353 Pinza ensalada / Salad tong /
 Pince à salade / Salatzange



REF	L cm	
P353.000	26,5	1

46928 Pinza Pan / Bread tong /
 Pince à pain / Brotzange



REF	L cm	
46928	23,5	12

P606 Pinza pan / Bread tong /
 Pince à pain / Brotzange



REF	L cm	
P606.000	25	1

P605 Pinza pasta / Pasta tong /
 Pince à pâtes / Nudلزange



REF	L cm	
P605.000	24	1

P351 Pinza spaghetti / Spaghetti tong /
 Pince à spaghetti / Spaghetizange



REF	L cm	
P351.000	19	12

P352 Pinza repostería / Cake tong /
 Pince à gâteau / Konditoreizange



REF	L cm	
P352.000	18	1

P617 Pinza anillas / Tong with ring /
 Tong with ring / Zange mit Ringen



REF	L cm	
P617.017	17	1

P618 Pinza hamburguesa / Burger tong /
Pince à "burger" / Hamburgerzange



REF	L cm	
P618.000	24	1

46929 Pinza pastelería / Pastry tong /
Pince à pâtisserie / Gebäckzange



REF	L cm	
46929	20	24

P615 Cascanueces / Nut cracker /
Casse-noix / Nussknacker



REF	L cm	
P615.000	16,5	1

P6151 Cascanueces inox / St/Steel nut cracker /
Casse-noix en inox / Edelstahl Nussknacker



REF	L cm	
P615.100	16,5	6

P389 Pinza para mariscos en aluminio /
Aluminium lobster cracker /
Casse-pattes en aluminium /
Meeresfrüchtezange aus Aluminium



REF	L cm	
P389.000	14	1

P902 Pinza charcutería / Butcher's tong /
Pince à charcuterie / Metzgereizange



REF	L cm	
P902.000	10,5 x 5	1

46760 Pinza caracoles /
Snail tong, mirror-finished stainless steel /
Pince à escargot, inox ultra-brillant /
Schneckenzange, glänzender Edelstahl



REF	L cm	
46760	15,2	12

VER PRODUCTOS EN / SEE PRODUCTS ON /
VOIR PRODUITS EN PAGE / SIEHE PRODUKTE IN

PINZAS / TONGS /
PINCES / ZANGEN



P. 97

**Poste separación acero inoxidable /
St/Steel barrier /
Poteau acier inoxydable /
Seperationspfosten rostfreier Stahl**

P19100

P19.100
Pulido brillante.
Mirror Polished.
Polissage brillant.
Glänzend poliert.

P19.101
Baño dorado.
Golden coated.
Doré.
Goldbeschichtet.

Cordón no incluido
Belt not included
Cordon non inclus
Seil nicht inklusive

Ref. P19.100



Ref. P19.101



REF	H cm	Kg	
P19.100	95	10,5	1
P19.101	100	10,5	1

**Recambio cabezal poste /
Spare head for barrier /
Rechange de sangle /
Ersatzkopf für Pfosten**

P19115



Para poste / For barrier /
Pour poteau / Für Pfosten
P19.114

REF	COLOR / COLOUR / COULEUR / FARBE	L cm	
P19.115-N		200	1
P19.115-A		200	1
P19.115-R		200	1

**Cordón con ganchos cromados /
Belt with chromium-plated ends /
Cordon à crochets chromés /
Seil mit verchromten Haken**

P19105



REF	COLOR / COLOUR / COULEUR / FARBE	L cm	
P19.105		150	1
P19.107		150	1
P19.103		150	1

**Poste con cinta retráctil /
Barrier with retractable belt /
Poteau dérouleur à sangle /
Pfosten mit einziehbarem rotem Band**

P19114

INOX - ST/STEEL
ROSTFREIER STAHL

Pulido brillante.
Mirror Polished.
Polissage brillant.
Glänzend poliert.

Cabezal removable.
Detachable head.
Tête amovible.
Kopf abnehmbar.



REF	COLOR / COLOUR / COULEUR / FARBE	H cm	L cm	Kg	
P19.114N		94	200	9	1
P19.114A		94	200	9	1
P19.114R		94	200	9	1

**Panel información / Information sign /
Panneau information / Informationsschild**

P19116



Para poste / For barrier /
Pour poteau / Für Pfosten
P19.114

REF	cm	
P19.116	21,8 x 32	1

**Cordón con ganchos dorados /
Belt with golden ends /
Cordon à crochets dorés /
Seil mit vergoldeten Haken**

P19106



REF	COLOR / COLOUR / COULEUR / FARBE	L cm	
P19.106		150	1
P19.104		150	1

SEÑALIZACIÓN / SIGNS / SIGNALISATION / MARKIERUNG

Fabricadas con un material plástico especial que no se raya. Marcos de madera resistentes al agua y al sol. Pizarras especialmente diseñadas para el uso de tizas o rotuladores con base de agua.

Produced from special plastic completely anti-scratch material. Solid wood frame double-lacquered. Rain and sunproof. Writing-surfaces specially designed for using water based chalkmarkers.

Fabriqués avec un matériel plastique spécial anti-rayures. Cadres en bois massif. Résistants à la pluie et au soleil. Tableaux spécialement conçus pour l'utilisation des craies ou marqueurs avec base à eau.

Hergestellt aus einem speziellem Plastik, welches nicht verkratzt. Rahmen aus Holz resistent gegen Wasser und Sonne. Spezielles tafeldesign für den gebrauch von Kreide und Filzstiften.

P21000 / P21001 Caballete - Duo



REF	A cm	B cm	
P21.000	75	135	1
P21.001	55	85	1

P21003 Caballete - Uno



REF	A cm	B cm	
P21.003	55	85	1

P2100 Universal



REF	A cm	B cm	
P21.004	40	50	1
P21.005	50	60	1
P21.006	60	80	1
P21.008	80	100	1

P2101 Lucky

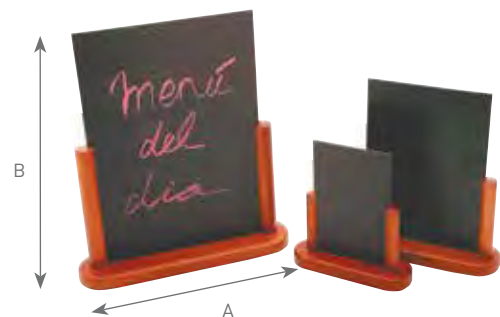

REF	A cm	B cm	
P21.015	10	15	1
P21.016	15	21	1
P21.017	21	30	1

P2102 Basic

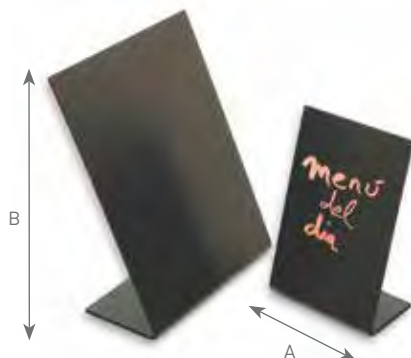

REF	A cm	B cm	
P21.027	10	15	1
P21.028	15	23	1
P21.029	21	31	1

P21020-26

**Marcadores tiza fluorescentes, grueso 2 - 6 mm /
Fluorescent Chalkmarkers widths, 2 - 6 mm /
Marqueurs fluorescents épaisseur, 2 - 6 mm /
Fluoreszierende Kreidemarker, Breite 2 - 6 mm**

Resistentes a la lluvia. Fácil de borrar con un trapo húmedo /
Rainproof. Easy to wipe off with damp cloth /
Résistants à la pluie. S'efface facilement avec un chiffon humide /
Resistent gegen Regen. Einfach zu löschen mit einem feuchten Tuch



REF	Color/Couleur	
P21.020	Blanco / White / Blanc / Weiss	1
P21.023	Amarillo / Yellow / Jaune / Gelb	1
P21.025	Naranja / Orange / Orange / Orange	1



SERVICIO DE MESA /
TABLE SERVICE /
ARTS DE TABLE /
TAFELSERVICE

13.1 MINIATURAS HIERRO FUNDIDO / CAST IRON MINIATURES / MINIATURES FONTE ÉMAILLÉE / MINIATUREN GUSSEISEN 486

13.2 PRESENTACIÓN BUFFET / BUFFET PRESENTATION / PRÉSENTATION BUFFET / BUFFET-PRÄSENTATION 489

LLAUNAS PRESENTACIÓN / TIN PLATES DISPLAY / PLATEAUX INOX PRÉSENTATION / PRÄSENTATIONSTABLETTES	489
PIZARRAS / SLATES / ARDOISES / SCHIEFFERTFELN	490
BAMBÚ NATURAL & MADERA / NATURAL BAMBOO & WOODEN BAMBOU NATUREL & BOIS / NATURBAMBUS & HOLZ	492
CESTA PAN / BREAD BASKET / CORBEILLE À PAIN / BROTKORB	495
CESTAS POLIPROPILENO / POLYPROPYLENE BASKETS / CORBEILLES POLYPROPYLÈNE / POLYPROPYLEN KÖRBE	496
MANTELES INDIVIDUALES / PLACE MATS / SETS DE TABLE / PLATZMATTEN	500

13.3 SERVICIO DE MESA / TABLE SERVICE / SERVICE DE TABLE / TISCHSERVICE 502

MOLINILLOS PIMIENTA Y SAL / PEPPER MILL-SALT MILL / MOULINS À POIVRE ET SEL / PFEFFER- UND SALZMÜHLEN	502
SALSERAS / FLARED SAUCE CUPS / SAUCIÈRES / GEWELLTE SOSENSCHALEN	503
COMPLEMENTOS DE MESA / TABLE ACCESSORIES / ACCESSOIRES DE TABLE / TISCHACCESSOIRES	504
SERVILLETTERO / NAPKIN HOLDER / PORTE-SERVIETTES / SERVIETTENSPENDER	507
PORTAMENÚS / MENU HOLDERS / PORTE-MENUS / KARTENHALTER	508
TAPAS PARA PLATOS / PLATE COVERS / COUVERCLES À ASSIETTE / TELLERHAUBEN	509

13.1 MINIATURAS / MINIATURE POTS / MINIATURES / MINIATURGEFÄSSE

Miniaturas hierro fundido / Cast Iron Miniatures /
Miniatures fonte émaillée / Miniaturen Gusseisen



ESPAÑOL

Miniaturas en hierro fundido y esmaltado interior, perfectas para servicio individual y presentación /

ENGLISH

Enamelled cast iron miniatures perfect for individual service and presentations /

FRANÇAIS

Miniatures en fonte émaillée (à l'intérieur) idéales pour le service individuel et la présentation /

DEUTSCH

Miniaturen aus innen emailierten Gusseisen eignen sich perfekt für den individuellen Service und Präsentation.

P23500 Mini sartén / Mini fry pan / Mini poêle ronde / Minibratpfanne



REF	Ø cm	L cm	H cm	
P23.500	10,5	16	2,6	1

P23501 Mini sartén / Mini fry pan / Mini poêle ronde / Minibratpfanne



REF	Ø cm	L cm	H cm	
P23.501	13,5	21	2,5	1

P23502 Mini sartén alta / Mini deep fry pan / Mini poêle ronde haute / Hohe Minibratpfanne



REF	Ø cm	L cm	H cm	
P23.502	14	23,5	3,8	1

P23503 Mini sartén cuadrada / Mini squared fry pan / Mini poêle carrée / Quadratische Minibratpfanne



REF	cm	L cm	H cm	
P23.503	13,6 x 13,6	23,3	3,6	1

P23504 Mini sartén rectangular /
Mini oblong fry pan /
Mini poêle rectangulaire /
Rechteckige Minibratpfanne



REF	cm	L cm	H cm	
P23.504	12,7 x 10,5	18	2,5	1

P23508 Cacerola oval /
Oval casserole /
Mini casserole ovale /
Ovale Kasserolle



REF	cm	H cm	Lts	
P23.508	21,5 x 15,5	6,5	0,60	1

P23505 Mini cacerola con tapa /
Mini round casserole with lid /
Mini cocotte avec couvercle /
Minikasserolle mit Deckel



REF	Ø cm	L cm	H cm	Lts	
P23.505	10	13	7,5	0,20	1

P23507 Cacerola alta con tapa /
High round casserole with lid /
Cocotte haute avec couvercle /
Hohe Kasserolle mit Deckel



REF	Ø cm	H cm	Lts	
P23.507	14	9,5	0,70	1

P23506 Mini fuente oval con tapa /
Mini oval pan with lid /
Mini plateau ovale avec couvercle /
Mini Buffetschale mit Deckel



REF	cm	L cm	H cm	
P23.506	12 x 8	15,5	5,0	1

P23509 Mini fuente oval alta con tapa /
High mini oval pan with lid /
Mini plateau ovale haut avec couvercle /
Ovale hohe Minibuffetschale mit Deckel



REF	cm	H cm	Lts	
P23.509	12,5 x 9,3	7,5	0,25	1

13.1 MINIATURAS / MINIATURE POTS / MINIATURES / MINIATURGEFÄSSE

VER PRODUCTOS EN / SEE PRODUCTS ON / VOIR PRODUITS EN PAGE / SIEHE PRODUKTE IN

MINIATURAS DE MELAMINA /
MELAMINE MINIATURES /
MINIATURES DE MÉLANINE /
MELAMIN-MINIATUREN



P. 400

VER PRODUCTOS EN / SEE PRODUCTS ON / VOIR PRODUITS EN PAGE / SIEHE PRODUKTE IN

MINIATURAS DE ALUMINIO DE FUNDICIÓN /
CAST ALUMINIUM MINIATURES /
MINIATURES EN FONTE D'ALUMINIUM /
ALUMINIUMGUSS MINIATUREN



P. 41

VER PRODUCTOS EN / SEE PRODUCTS ON / VOIR PRODUITS EN PAGE / SIEHE PRODUKTE IN

SARTÉN ESMALTADA CON ASAS /
ENAMELLED FRY PAN WITH HANDLES /
POÊLE AVEC ANSES ÉMAILLÉ
PAELLAPFANNE AUS EMAILLIERTEM MIT GRIFFEN

MINI-SIZE



P. 64

LLAUNAS PRESENTACIÓN / TIN PLATES DISPLAY / PLATEAUX INOX PRÉSENTATION / PRÄSENTATIONSTABLETTS



ACERO INOXIDABLE / STAINLESS STEEL /
ACIER INOXYDABLE / EDELSTAHL



IDEA!

IDEAL PARA ARROCES, CARACOLES Y CARNES Y PESCADOS AL HORNO /
IDEAL FOR BAKED RICE, SNAILS, MEATS AND FISH /
IDÉAL POUR DES RECETTES COMME PAËLLA, ESCARGOTS, PIÈCES DE VIANDES /
IDEAL FÜR REISGERICHTE, SCHNECKEN UND FLEISCH UND FISCHSPEISEN AUS DEM OFEN

*Sólo para placas inducción mantenedoras /
Only for warming induction units /
Uniquement pour plaques induction de maintien en température /
Nur für Warmhalte-Induktionsplatten

P29610

Llauna arroz bandeja presentación con mango /
Paella sheet pan with wooden tray with handle /
Plateau de présentation du riz avec manche /
Blech Präsentationstablett für Reis mit Stiel



REF	LLAUNA		TOTAL		📦
	cm	H cm	cm	H cm	
P29.610	22 x 14	2	34 x 18	3	6

P29600

Llauna arroz bandeja presentación /
Paella sheet pan with wooden tray /
Plateau de présentation du riz /
Blech Präsentationstablett für Reis



REF	LLAUNA		TOTAL		📦
	cm	H cm	cm	H cm	
P29.600	29,5 x 19,5	2	33 x 23	3	6

P1950

Llauna arroz bandeja gastronorm 1/1 presentación / Paella 1/1 GN sheet pan /
Plateau GN 1/1 de présentation du riz / Blech GN-Tablett Reis 1/1 Präsentation



GN 1/1



REF	LLAUNA		TOTAL		📦
	cm	H cm	L cm	H cm	
P195.000	48 x 32	2	52,5	6	6

P296

Llauna bandeja presentación redonda / Round sheet pan with wooden tray /
Plateau rond de présentation / Blech Präsentationstablett rund



REF	LLAUNA		TOTAL		📦
	Ø cm	H cm	L cm	H cm	
P29.620	20	4,5	31	5,5	6
P29.630	26	4,5	37	5,5	6

IDEA!

Ideal para servir en mesa
Ideal for table top service
Idéal pour service de table
Ideal zum servieren am Tisch

13.2 PRESENTACIÓN BUFFET / BUFFET PRESENTATION / PRÉSENTATION BUFFET / BUFFET-PRÄSENTATION



PIZARRAS / SLATES / ARDOISES / SCHIEFERPLATTEN

Presentación natural, elegante y exclusiva de platos fríos o calientes.

Natural, elegant and exclusive presentation of cold or hot plates.

Présentation naturelle, élégante et exclusive de plats froids ou chauds.

Naturelle, exclusive und elegante Präsentation von kalten und warmen Speisen.

P28600 Tabla pizarra y acacia / Slate and acacia board / Plateau ardoise et bois / Schieferplatte und Akazie



REF	cm	H cm	
P28.600	33 x 23	1,5	1

P28610 Tabla pizarra y acacia / Slate and acacia board / Plateau ardoise et bois / Schieferplatte und Akazie



REF	cm	L cm	H cm	
P28.610	26 x 18	34	1,5	1

P28620 Tabla pizarra y acacia / Slate and acacia board / Plateau ardoise et bois / Schieferplatte und Akazie



REF	Ø cm	L cm	H cm	
P28.620	21,0	31	1,5	1
P28.621	26,5	37	1,5	1

VER PRODUCTOS EN / SEE PRODUCTS ON / VOIR PRODUITS EN PAGE / SIEHE PRODUKTE IN

**BANDEJA PRESENTACIÓN /
DISPLAY TRAY /
PLATEAU PRÉSENTATION /
PRÄSENTATIONSSCHALE**



P. 76

PRESENTACIÓN BUFFET / BUFFET PRESENTATION /
PRÉSENTATION BUFFET / BUFFET-PRÄSENTATION

PIZARRAS / SLATES /
ARDOISES / SCHIEFFERTFELN

CANTOS PULIDOS / POLISHED EDGES /
COINS BISEAUTÉS / ABGESCHRÄGTE ECKEN

PIES ESPUMADOS / RUBBER FEET /
PIEDS MOUSSE / SCHAUMSTOFFFÜSSE

4-5 mm

ESPESOR / THICKNESS /
EPAISSEUR / DICKE



P28202 Pizarra presentación / Slate serving tray / Ardoise presentation / Schieferplatte



REF	cm	
P28.202	20 x 20	24
P28.252	25 x 25	16
P28.303	30 x 30	12
P28.302	30 x 20	16
P28.403	40 x 30	10

P28501 Pizarra presentación / Slate serving tray /
Ardoise presentation / Schieferplatte



REF	cm	
P28.501	25 x 25	1
P28.502	30 x 30	1
P28.503	30 x 20	1
P28.504	40 x 30	1

P28505 Pizarra presentación / Slate serving tray /
Ardoise presentation / Schieferplatte



REF	Ø cm	
P28.505	20	1
P28.506	30	1

PIES ESPUMADOS / RUBBER FEET /
PIEDS MOUSSE / SCHAUMSTOFFFÜSSE

SUPERFICIE RÚSTICA / ROUGH SURFACE /
SURFACE RUSTIQUE / RUSTIKALE OBERFLÄCHE

CANTOS NATURALES / NATURAL EDGES /
COINS NATURELS / NATÜRLICHE ECKEN

5-6 mm

ESPESOR / THICKNESS /
EPAISSEUR / DICKE

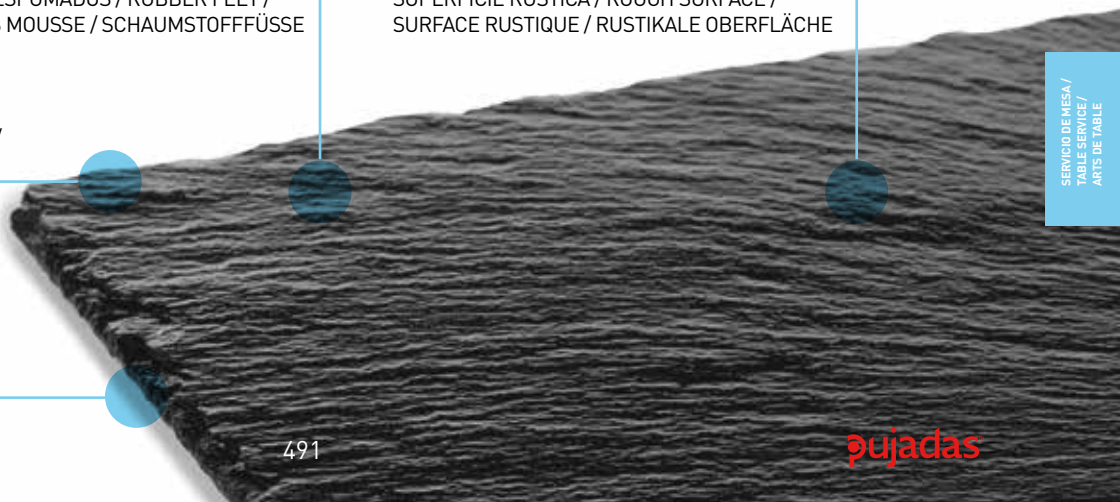

SERVICIO DE MESA /
TABLE SERVICE /
ARTS DE TABLE

13.2 PRESENTACIÓN BUFFET / BUFFET PRESENTATION / PRÉSENTATION BUFFET / BUFFET-PRÄSENTATION

BAMBÚ NATURAL & MADERA / NATURAL BAMBOO & WOOD / BAMBOU NATUREL & BOIS / NATURBAMBUS & HOLZ

NATURAL FIBERS

GAMA PRESENTACIÓN BAMBÚ NATURAL PARA LOS MÁS EXIGENTES.

NATURAL BAMBOO PRESENTATION RANGE FOR THE MOST DEMANDING HOTELS AND RESTAURANTS.

GAMME DE PRÉSENTATION BAMBOU NATUREL PLUS EXIGEANTS.

PRÄSENTATIONSREIHE NATURBAMBUS FÜR DEN HÖCHSTEN ANSPRUCH.



P10051 Tabla bambú presentación sushi / Bamboo sushi board / Planche bambou présentation sushi / Bambus Sushitisch



REF	cm	H cm	
P100.511	24 x 15	3,0	24
P100.512	27 x 18	3,0	24

P10052 Tabla curvada bambú sushi / Curved bamboo sushi board / Planche incurvée bambou présentation sushi / Gebogener Bambus Sushitisch



REF	cm	H cm	
P100.520	21 x 12	2,5	36
P100.521	24 x 15	3,0	24
P100.522	27 x 18	3,0	24

P10060 Barco presentación sushi / Sushi boat presentation / Bateau présentation sushi / Präsentations Sushi-Boot



REF	cm	H cm	
P100.600	50 x 20	31,0	6
P100.601	70 x 25,5	45,0	6

P10054 Vaporera bambú redonda / Round bamboo steamer /
Cuit vapeur bambou rond / Runder Bambus Dampfgarer

Sin tapa / Without lid / Sans couvercle / Ohne Deckel



REF	cm	H cm	
P100.540	10	4,0	375
P100.541	13	5,0	224
P100.542	15	5,0	144
P100.543	21	5,0	72
P100.544	27	5,5	44

P10055 Tapa vaporera redonda / Round steamer lid /
Couvercle cuit vapeur rond / Runder Dampfgarerdeckel



REF	Ø cm	H cm	
P100.550	10	3,0	500
P100.551	13	3,5	272
P100.552	15	3,5	204
P100.553	21	4,0	102
P100.554	27	4,0	60

P10053 Bandeja rectangular presentación sushi / Sushi rectangular tray /
Plateau rectangulaire présentation sushi / Sushi-Tablett, rechteckig



REF	cm	H cm	
P100.530	33 x 22,5	8,0	6
P100.531	42 x 32	8,5	6

P10057 Pinza bambú / Bamboo tong / Pince bambou / Bambuszange



REF	L cm	
P100.570	20,0	780
P100.571	25,5	504
P100.572	30,0	444



CESTA PAN / BREAD BASKET / CORBEILLE À PAIN / BROTKORB

N

BEST
SELLER

P100816 Cesta pan marrón / Brown bread basket / Corbeille à pain marrón / Brauner Brotkorb

Papel / Paper /
Papier / Papier

N

P100.807



REF	cm	H cm	
P100.816	13,0 x 13,0	15	12
P100.807	17,5 x 17,5	15	12
P100.836	26,5 x 26,5	12	12

Se puede lavar / Washable/
Peuvent se laver / Kann gewaschen werden

P100808 Cesta pan gris / Grey bread basket / Corbeille à pain gris / Grauer Brotkorb

Papel / Paper /
Papier / Papier

N

P100.808



P100.838



REF	cm	H cm	
P100.808	13,0 x 13,0	15	12
P100.827	17,5 x 17,5	15	12
P100.838	26,5 x 26,5	12	12

Se puede lavar / Washable/
Peuvent se laver / Kann gewaschen werden

P100817 Cesta pan negra / Black bread basket / Corbeille à pain noir / Schwarz Brotkorb

Papel / Paper /
Papier / Papier

N

P100.826



REF	cm	H cm	
P100.817	13,0 x 13,0	15	12
P100.826	17,5 x 17,5	15	12
P100.837	26,5 x 26,5	12	12

Se puede lavar / Washable/
Peuvent se laver / Kann gewaschen werden

P10074 Cesta pan / Bread basket / Corbeille à pain / Brotkorb

REF	cm	H cm	
P100.740	29 x 29	47,5	12
P100.741	36 x 30	21 / 39	6
P100.742	Ø 29	21 / 39	6
P100.780	Ø 35	35	12



P100.740



P100.741







P100.742



P100.780

P10075 Cesta redonda inclinada / Slated bread basket / Corbeille ronde inclinée / Schräger runder Korb

REF	Ø cm	H cm	
 P100.752	36	10 / 20	6
 P100.753	40	13 / 23	6
 P100.754	36	10 / 20	6
 P100.755	40	13 / 23	6



P100.752
P100.753



P100.754
P100.755

P10076 Cesta rectangular inclinada / Slated rectangular basket /
Corbeille rectangulaire inclinée / Schräger rechteckiger Korb

REF	cm	H cm	
P100.760	40 x 28	6 / 10	12
P100.761	58 x 38	8 / 12	6



P10077 Cesta rectangular dos compartimentos / Two compartment rectangular basket /
Corbeille rectangulaire deux compartiments / Rechteckiger Korb zwei Unterteilungen

REF	cm	H cm	
P100.770	49 x 31	10 / 14,3	6









P10079 Cesta redonda / Round basket / Corbeille ronde / Runder Korb

REF	Ø cm	H cm	
 P100.790	31	7,0	12
 P100.792	24	5,5	60



P10080 Cesta redonda / Round basket / Corbeille ronde / Runder Korb

REF	Ø cm	H cm	
 P100.800	18,5	7,5	48
 P100.803	18	6,0	48
 P100.804	23	6,0	48
 P100.805	25	6,0	48







P100.800

P100.804

P100.803

P100.805

P10081 / P10082 Cesta redonda / Round basket / Corbeille ronde / Runder Korb

REF	Ø cm	H cm	
 P100.813	18,5	6,0	84
 P100.814	23	6,0	84
 P100.820	18,5	6,0	84
 P100.821	23	6,0	84



P100.813

P100.820

P100.814

P100.821

P10090 Cesta oval / Oval basket / Corbeille ovale / Ovaler Korb

REF	cm	H cm	
P100.900	30 x 23,5	7,5	36



P10084 Cesta rectangular /
Rectangular basket /
Corbeille rectangulaire /
Rechteckiger Korb



REF	cm	H cm	
P100.840	21,5 x 18	8,0	84
P100.841	26 x 20	7,5	48
P100.842	23 x 23	9,0	12

P10085 Cesta rectangular /
Rectangular basket /
Corbeille rectangulaire /
Rechteckiger Korb



REF	cm	H cm	
P100.851	40 x 28,5	7,0	24

P10086 Cesta rectangular /
Rectangular basket /
Corbeille rectangulaire /
Rechteckiger Korb



REF	cm	H cm	
P100.860	37 x 27	7,0	24
P100.861	46 x 34	7,0	24
P100.862	46 x 34	12,0	12

P10087 Cesta rectangular /
Rectangular basket /
Corbeille rectangulaire /
Rechteckiger Korb



REF	cm	H cm	
P100.870	37 x 26	7,0	12
P100.871	42 x 30	7,0	24

P10088 Cesta oval / Oval basket /
Corbeille ovale / Ovaler Korb



REF	cm	H cm	
P100.880	18 x 12	6,5	60
P100.881	23,5 x 15	7,0	60
P100.882	28 x 14,5	7,5	36

P10089 Cesta oval / Oval basket /
Corbeille ovale / Ovaler Korb



REF	cm	H cm	
P100.890	19 x 13	7,0	48
P100.891	25 x 15	8,0	60
P100.892	29 x 19	10,0	60

P10093 Cesta para cubiertos / Cutlery dispenser / Corbeille à couverts / Besteckkorb



REF	cm	H cm	
P100.931	30 x 11	7,0	96
P100.932	30 x 11	7,0	96

P10094 Cesta para cubiertos / Cutlery dispenser / Corbeille à couverts / Besteckkorb





REF	Ø cm	H cm	
P100.940	13	14,0	36

P10095 Cesta buffet rectangular / Rectangular buffet basket / Corbeille rectangulaire buffet / Rechteckiger Buffetkorb

GN 1/1



REF	Ø cm	TOTAL H cm	BASE H cm	
 P100.950	53 x 31,5	26,0	8,5	12
 P100.951	53 x 31,5	26,0	8,5	12
P100.955*				6

*Tapa / Lid / Couvercle / Deckel
Policarbonato / Polycarbonate
Polycarbonate / Polycarbonat

P10096 Cesta buffet redonda / Round buffet basket / Corbeille ronde buffet / Runder Buffetkorb



REF	Ø cm	H cm	
P100.960	40	30	24
P100.965*			6

*Tapa / Lid / Couvercle / Deckel
Policarbonato / Polycarbonate
Polycarbonate / Polycarbonat

**MANTELES INDIVIDUALES /
PLACE MATS /
SETS DE TABLE /
PLATZMATTEN**



Manteles individuales fabricados en PVC + poliéster. Para su limpieza se aconseja usar una esponja o trapo húmedo.

Place mats made of PVC + polyester. To clean please use a damp sponge or cloth

Sets de table fabriqués en PVC + polyester. Nettoyer à l'aide d'une éponge ou un chiffon humide.

Individuelle PlatzMatten Hergestellt aus PVC + Polyester. Für die einfache Reinigung empfehlen Wir einen Schwamm oder ein Feuchtes tuch.

P92605 Manteles individuales DECO / DECO place mats / Sets de table DECO / Individuelle Platzmatten DECO



P926.051



REF	cm	
P926.051	45 x 30	6
P926.052	45 x 30	6
P926.053	45 x 30	6

Precio / Price / Prix / Preis: Pack 6 u.

Líneas marrones-negras / Brown&Black Lines / Lignes marrons et noirs / Braune und schwarze Linien

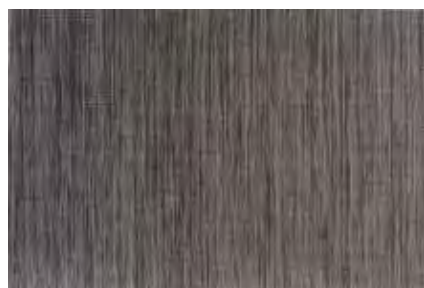

P926.052



Marrón-negro / Brown&Black / Marron et noir / Braun - Schwarz



P926.053



Negro / Black / Noir / Schwarz

P9260 Mantel individual trama fina / Place mat fine band / Set de table maille fine / Platzmatte feinmaschig



REF	cm	
P926.006	45 x 30	6
P926.007	45 x 30	6
P926.008	45 x 30	6
P926.009	45 x 30	6

Precio / Price / Prix / Preis: Pack 6 u.

Marrón / Brown /
Marron / Braun



P926.006

Café / Coffee /
Café / Kaffee

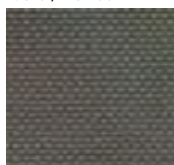

P926.007

Negro-Blanco /
Black&White /
Noir et blanc /
Schwarz-Weiss



P926.008

Verde / Green /
Vert / Grün

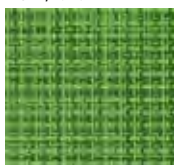

P926.009

P926 Mantel individual trama gruesa / Place mat wide band /
Set de table maille épaisse / Platzmatte grobmaschig

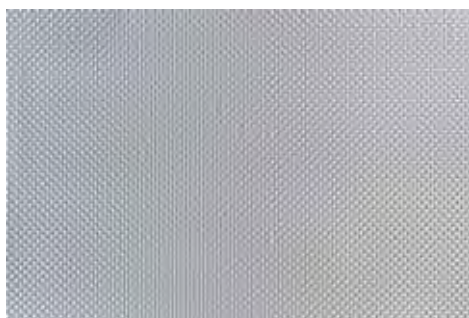

REF	cm	
P926.002	45 x 30	6
P926.003	45 x 30	6
P926.004	45 x 30	6
P926.005	45 x 30	6
P926.010	45 x 30	6
P926.011	45 x 30	6
P926.012	45 x 30	6

Precio / Price / Prix / Preis: Pack 6 u.

Naranja / Orange

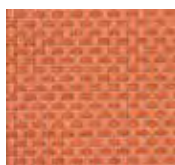

P926.002

Burdeos /
Burgundy /
Bordeaux /
Bordeauxrot



P926.003

Negro /
Black /
Noir /
Schwarz

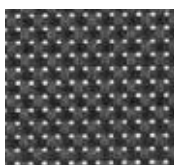

P926.004

Marrón-Negro /
Brown&Black /
Marron et noir /
Braun-Schwarz



P926.005

Marrón-Plata /
Brown&Silver /
Marron Et Argent /
Braun Versilbert



P926.010

Marrón-Dorado /
Brown&Gold /
Marron Et Doré /
Braun-Vergoldet

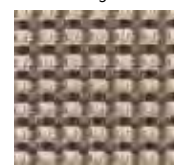

P926.011

Plateado /
Silver /
Argent /
Versilbert



P926.012

P96700 Molinillos pimienta y sal. Madera / Pepper mill-salt mill. Wooden /
Moulins à poivre et sel. Bois / Pfeffer- und Salzmühlen. Holz



REF	H cm	
P967.007	12,5	1
P967.008	15,0	1
P967.009	19,5	1



P967009

P967008

P967007

P967 Molinillos pimienta y sal. Acrílico / Pepper mill-salt mill. Acrylic /
Moulins à poivre et sel. Acrylique / Pfeffer- und Salzmühlen. Acryl.

	REF	TIPO /TYPE	H cm	
A	P967.001	A	15,5	1
	P967.002	A	20,0	1
	P967.003	A	23,0	1
B	P967.004	B	15,5	1
	P967.005	B	20,0	1
	P967.006	B	23,0	1



A
Pimienta /
Pepper /
Poivre /
Pfeffer



B
Sal /
Salt /
Sel /
Salz

Salseras / Flared Sauce Cups / Saucières / Gewellte Sossenschalen

Exterior brillante e interior satinado. Retiene la temperatura durante un tiempo más prolongado que los recipientes de plástico o melamina.

Mirror-finished outside, satin-finished inside. Retains temperature longer (than plastic or melamine). Flared design is attractive, and allows for easier dipping or pouring.

Ultra-brillant à l'extérieur ; satiné à l'intérieur. Retient la chaleur plus longtemps que le plastique ou la mélamine. Forme évasée attrayante; plus facile pour tremper ou verser.

Hochglanzpoliertes Äußeres, mattpoliertes Inneres. Konserviert die Temperatur länger (als Plastik oder Melamin). Design mit nach oben zunehmendem Durchmesser ist attraktiv und ermöglicht ein einfacheres Eintauchen und Ausgießen.

46714 / 46716 Recipiente para salsas / Flared sauce cup / Saucière évasée / Soßenbecher

INOX - ST/STEEL
EDELSTAHL



46714

46716

REF	Ø cm	H cm	ml	
46714	7,6	4,1	118	12
46716	9,5	4,6	177	12

P333 Salsera / Gravy boat / Saucière / Sossenkännchen



REF	L	
P333.010	0,10	1
P333.020	0,20	1
P333.035	0,35	1

P623 Portasalados o portasalsas / Snack bowl set or sauce bowl set / Ensemble bols pour snacks ou sauces / Snack- oder Sossenständer



REF	UNI.	Ø cm/U	ml/U	
P623.003	3	9	200	1

P2440 Mini cubo / Mini bucket / Mini seau / Minieimer

INOX - ST/STEEL
EDELSTAHL
18/10



REF	Ø cm	H cm	L	
P24.407	7,5	6,5	0,15	6
P24.409	9,0	8,5	0,32	6

P625 Pala recogemigas / Table crumber / Pelle ramasse-miettes / Krümmelschaufel

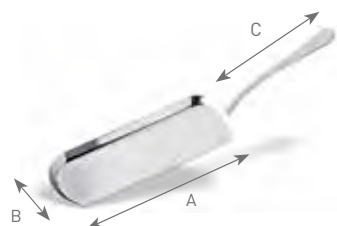

REF	A x B x C cm	
P625.000	18 x 7 x 12,5	1

P630 Soporte para número "banquete" / Number card holder / Support numéro "banquet" / Bankettnummerhalter



REF	H cm	
P630.010	10	1
P630.020	20	1
P630.030	30	1
P630.040	40	1

P632 Número de mesa / Table number / Numéro de table / Tischnummer

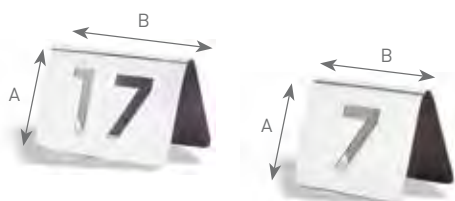

REF	A x B cm	
P632.00 + NUM*	5,6 x 6,4	1
P632.0 + NUM**	5,6 x 7,6	1

* número de 1 dígito. ** número de 2 dígitos.
 * number with 1 digit. ** number with 2 digits.
 * numero d'un seul chiffre. ** numero de 2 chiffres.
 * number with 1 digit. ** number with 2 digits.

N. 1 - N. 30

P633 Placa "Reservado" / "Reserved" table sign / Plaque "reserve" / "Reserviert" Schild

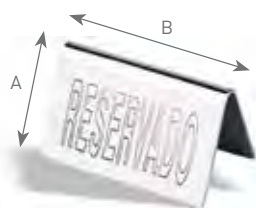

REF	TEXT	A x B cm	
P633.000	RESERVADO	5 x 10	1
P633.002	RESERVED	5 x 10	1
P633.003	RESERVE	5 x 10	1

P634 Placa "Prohibido fumar" / "Non-smoking" sign / Plaque "Défense de fumer" / "Nichtraucher" Schild



REF	A x B cm	
P634.000	5,6 x 7,6	1

**Soporte de mesa para bandeja marisco /
Stand for sea food tray /
Support pour plateau fruits de mer /
Ständer für Meeresfrüchteplatte**

P969



REF	Ø cm	H cm	
P969.000	25 / 20	19,0	1

**Pincho /
Skewer /
Brochette /
Spieß**

P9681



Precio caja 12 unidades.
Price 12 units box.
Prix colis 12 unités.
Preis Kiste 12 Teile.

REF	L cm	
P968.125	25	12
P968.130	30	12
P968.135	35	12

**Porta brochetas / Carry-skewers /
Porte-brochettes / Spiesshalter**

P968



REF	Ø cm	H cm	
P968.000	22	46	1

**Pinchanotas / Bill spike /
Epingle porte-tickets / Bonspiess**

P874



REF	Ø cm	H cm	
P874.000	9	22	1

**Bandeja oval antideslizante / Non slip
oval serving tray / Plateau antidérapant
forme ovale / Ovales Servicetabrett
Antirutschbeschichtung**

P8621



Color negro /Black color /
Couleur noir / Farbe Schwarz.

REF	cm	
P862.100	68 x 56	1

**Soporte para bandejas de gran tamaño /
Large tray holder /
Support pour grands plateaux /
Support pour grands plateaux**

P863



No incluye bandeja.
Serving tray not included.
Plateau non inclus.
Servicetabrett nicht enthalten.

REF	cm	H cm	
P863.000	47 x 47	82	1

P650 Papelera sobremesa acero inox / St/Steel table-tidy / Receptacle à déchets de table / Tischabfalleimer rostfreier Stahl

INOX - ST/STEEL
EDELSTAHL

REF	Ø cm	H cm	
P650.000	12	21	1



P638 Cenicero de agua / Water ashtray / Cendrier à eau / Wasseraschenbecher

INOX - ST/STEEL
EDELSTAHL



REF	Ø cm	H cm	
P638.000	11	5,5	1

P639 Cenicero hondo / Deep ashtray / Cendrier profond / Tiefer Aschenbecher

INOX - ST/STEEL
EDELSTAHL



REF	cm	
P639.000	12,5 x 12,5 x 2,5	1

VER PRODUCTOS EN / SEE PRODUCTS ON / VOIR PRODUITS EN PAGE / SIEHE PRODUKTE IN

MELAMINA /
MELAMINE /
MÉLAMINE /
MELAMIN



P. 403

P357

Servilletero / Napkin holder /
Porte-serviettes / Serviettenspender

INOX - ST/STEEL
EDELSTAHL



REF

P357.000



1

P25000

Servilletero madera /
Wooden napkin holder /
Porte-serviettes en bois /
Holz Serviettenspender



REF

P25.000



1

P25002

Servilletero madera con portamenús /
Wooden napkin holder with menu holder /
Porte-serviettes en bois avec porte-menús /
Holz Serviettenspender mit Kartenhalter

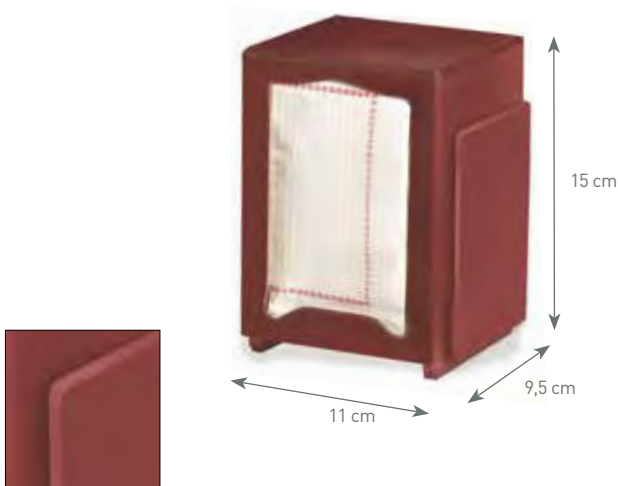

REF

P25.002



1

P25020

Servilletero madera con portamenús y palillero /
Napkin holder with menu and toothpick holder /
Porte-serviettes avec porte-cure-dents et porte-menús /
Holz Serviettenspender mit Zahnstocher und Kartenhalter



REF

P25.020



1

Fabricado en PVC. Bolsillos en contratapa interior. Para hojas DIN A4 y DIN A5. Personalización disponible.

Made of PVC. Pockets on each back cover. For DIN A4 and DIN A5 sheets. Personalisation available.

Fabriqué en PVC. Poches avec couverture intérieure. Pour feuilles DIN A4 et DIN A5. Personalisation disponible.

Hergestellt aus PVC. Hüllen im Inneren. Für din a4 und din a5 Blätter personalisierung möglich.

P2004

Portamenús Elegance / Elegance menu holder / Porte-Menus Elegance / Eleganz Menümappe

Para 10 páginas: 4 fundas dobles + 2 laterales.
Up to 10 pages: cover back + 4 double inner pages + back cover front.
Pour 10 pages: 4 feuilles plastiques doubles + 2 latérales.
Für 10 Blatt Papier - 2 Plastikhüllen auf Umschlagseiten + 4 Plastikhüllen.



REF	cm	COLOR / COLOUR		
P20.041	33 x 24	Burdeos / Burgundy / Bordeaux / Bordeauxrot		1
P20.042	33 x 24	Negro / Black / Noir / Schwarz		1
P20.043	33 x 24	Marrón / Brown / Marron / Braun		1

P20050

Porta blocs Elegance / Elegance Bill holder / Porte-addition Elegance / Eleganz Blockhalter



REF	cm	COLOR / COLOUR		
P20.050	23 x 13	Negro / Black / Noir / Schwarz		1

P636 Portamenús / Menu holder / Porte-menu de table / Menühalter

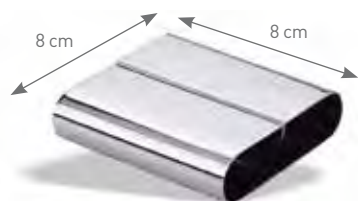

REF	H cm		
P636.000	2		1

P637/P6371

Platillo cambio / Bill holder / Porte-addition / Wechselgeldtellerche



REF	cm		
P637.000	15,5 x 11		1
P637.100	21,5 x 12,5		1

P20066 Porta facturas / Bill Holder / Porte-addition / Rechnungshalter



REF	cm	COLOR / COLOUR		
P20.066	24,5 x 17	Negro / Black / Noir / Schwarz		1
P20.069	20 x 13,5	Negro / Black / Noir / Schwarz		1

P635 Portatarjetas / Card holder / Porte-cartes / Kartenhalter

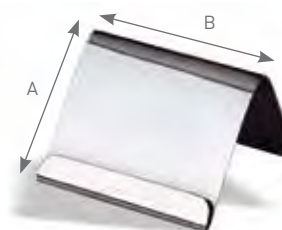

REF	A x B cm		
P635.000	5,2 x 6,2		1

Tapas para platos / Plate Covers / Couvercles à assiette / Tellerhauben

Las tapas para platos mantienen la comida a la temperatura ideal para servir. Se ofrecen con orificio central.

Plate covers keep food at its ideal serving temperature for improved customer satisfaction. Hemmed finger hole.

Les couvre-assiettes maintiennent les aliments à la température idéale de service pour améliorer la satisfaction du client. Trou ourlé pour passer le doigt.

Tellerhauben bewahren die ideale Serviertemperatur der Speisen zur höheren Zufriedenheit der Kunden. Gesäumtes Fingerloch.



62300 Tapas Acero inoxidable para platos / Stainless Steel Plate Covers / Inox couvercles à assiette / Edelstahl-Tellerhauben

INOX - ST/STEEL
EDELSTAHL



El acabado satinado mantiene más tiempo el buen aspecto de las tapas /
Satin-finish keeps covers looking better longer /
Fini satin pour un attrait durable /
Die matte Version behält das schöne Aussehen der Deckel längere Zeit.

Apilable / Stackable / Empilable / Stapelbar

REF	PARA / FOR / POUR / FÜR Ø cm	H cm	
62300	22,9 - 23,2	5,9	12
62302	23,7 - 23,8	5,9	12
62303	24,0 - 24,1	5,9	12
62312	26,8 - 27,0	5,9	12
62313	27,1 - 27,3	5,9	12
62314	27,5 - 27,6	5,9	12
62315	27,8 - 27,9	5,9	12
62318	28,1 - 28,3	5,9	12
62321	29,1 - 29,2	5,9	12
62326	30,6 - 30,8	5,9	12

918 Tapa plástico para platos / Plastic Plate Covers / Plastique couvercles à assiette / Kunststoff-Tellerhauben

 + 93°C



Transparente / Clear / Transparent

Apilable / Stackable / Empilable / Stapelbar

Lavavajillas / Dishwasher / lave-vaisselle / spülmaschinenfest

REF	PARA / FOR / POUR / FÜR Ø cm	H cm	
918-13	21,6 - 23,2	6,7	12
1078-13	26,7 - 27,0	7	12

Consultar otras medidas disponibles /
Ask about other available sizes /
Consulter autres dimensions disponibles /
Siehe weitere erhältliche Größen /

VER PRODUCTOS EN / SEE PRODUCTS ON / VOIR PRODUITS EN PAGE / SIEHE PRODUKTE IN

COLECTIVIDADES /
INSTITUTIONS /
COLLECTIVITÉS /
KOLLEKIVITAT



P. 544



14.1 BAR 512

CUBITERAS / WINE BUCKETS / SEAUX À CHAMPAGNE / KÜHLER	512
COCTELERIA / COCKTAIL SERVICE / COCKTAIL / COCKTAIL-SERVICE	516
ALFOMBRAS PARA BAR / BAR MATS / TAPIS DE BAR / BARMATTEN	518
DISPENSADOR DE CONDIMENTOS / CONDIMENT DISPENSERS / DISTRIBUTEUR DE CONDIMENTS / BEILAGENSPENDER	519
COMPLEMENTOS DE VINO / WINE COMPLEMENTS / ACCESSOIRES DU VIN / WEINZUBEHÖR	520
BANDEJAS / TRAYS / PLATEAUX/ TABLETS	522

14.2 TÉ Y CAFETERÍA / TEA & COFFEE SERVICE / THÉ ET CAFÉTÉRIA / TEE- UND KAFFEESERVICE 524

PLANET	524
COSMOS	526
ATLANTIS	526
TETERAS / TEA POTS / THÉIÈRES / TEEKANNE	527

14.3 SERVICIO DE BEBIDAS / BEVERAGE SERVICE SERVICE À BOISSONS / GETRÄNKE-SERVIC 528

SERVIDORES / SERVERS / VERSEUSES / GETRÄNKE-SERVIERKANNEN	528
JARRAS / PITCHERS / PICHETS / GETRÄNKEKRÜGE	530



Cubitera de plástico /
Plastic champagne bucket /
Seau à champagne /
Kunststoff-Sektkühler

P988400



REF	Ø cm	H cm	
P988.400	21	21,5	1

Cubitera bicolor plástico /
Bi-color plastic champagne bucket /
Seau à champagne bicolor /
Sektkühler zweifarbig Kunststoff

P988500



REF	Ø cm	H cm	
P988.500	19	21	1

Cubitera ovalada plástico /
Oval plastic champagne bucket /
Seau à champagne ovale /
Sektkühler ovalförmig Kunststoff

P988600



REF	cm	H cm	
P988.600	32,5 x 23,5	22	1

Cubitera de plástico /
Plastic champagne bucket /
Seau à champagne /
Kunststoff-Sektkühler

P988700



REF	cm	H cm	
P988.700	19,5	21	1

P988800 Cubitera ovalada plástico /
Oval plastic champagne bucket /
Seau à champagne ovale /
Sektkühler ovalförmig Kunststoff



REF	cm	H cm	
P988.800	30,5 x 22,5	24,5	1

P988900 Cubitera ovalada plástico /
Oval plastic champagne bucket /
Seau à champagne ovale /
Sektkühler ovalförmig Kunststoff



REF	cm	H cm	
P988.900	44,5 x 41,5	25	1

P9881 Cubitera cónica acrílica /
Conical acrylic champagne bucket /
Seau à champagne conique /
Konischer Acrylkühler



REF	Ø cm	H cm	
P988.100	20	18,5	12

P9882 Cubitera ovalada acrílica /
Oval acrylic champagne bucket /
Seau à champagne ovale /
Ovaler Acrylkühler

*3 BOTELLAS
*3 BOTTLES
*3 BOUTEILLES
*3 FLASCHEN



REF	cm	H cm	
P988.200	27 x 20	20	12
P988.300*	35 x 26	27	6

P990 Manta enfriadora / Wine cooler /
Rafraichisseur / Flaschenkühler

Reversible: burdeos y plata /
Reversible: burgundy and silver
Réversible: bordeaux et argenté /
Reversibel: bordeauxrot und silber



REF	cm	
P990.000	35 x 18	16

P646 Soporte de mesa para cubo champán /
Champagne bucket holder /
Support de table pour seau à champagne /
Tischhalterung für Champagnerkühler



Compatible con todos los modelos de cubos champán excepto con:
Suitable with all champagne bucket but:
Adaptable à tous les modèles sauf :
Geeignet für alle Modelle der Champagnerkühler ausser Artikel:
REF. P326

REF	Ø cm	cm	
P646.000	18	52 x 17	1

P311F71

Cubo champán cónico con anillas /
Conical champagne bucket with rings /
Seau à champagne conique à anneaux /
Konischer

INOX - ST/STEEL
EDELSTAHL
18/10



REF	Ø cm	H cm	
P311.071	20	19,5	1

P311F2

Cubo champán con asas fijas /
Champagne bucket with fixed handles /
Seau à champagne à poignées fixes /
Champagnerkühler mit festen Griffen

INOX - ST/STEEL
EDELSTAHL
18/10



REF	Ø cm	H cm	
P311.002	18	19	1

P311F6

Cubo champán con anillas /
Champagne bucket with rings /
Seau à champagne à anneaux /
Champagnerkühler mit Ringen

INOX - ST/STEEL
EDELSTAHL
18/10



REF	Ø cm	H cm	
P311.006	18	19	1

P326

Cubo champán dos botellas /
Champagne bucket two bottles /
Seau à champagne deux bouteilles /
Champagnerkühler zwei Flaschen

INOX - ST/STEEL
EDELSTAHL
18/10



REF	Ø cm	H cm	
P326.000	25	22	1

P9762

Cubo champán cónico con asas /
Conical champagne bucket with handles /
Seau à champagne conique avec poignées /
Konischer Champagnerkühler mit Griffen



REF	Ø cm	H cm	
P976.200	21	20	6

P9763

Cubo champán cónico con anillas /
Conical champagne bucket with rings /
Seau à champagne conique à anneaux /
Konischer Champagnerkühler mit Griffen



REF	Ø cm	H cm	
P976.300	19	19	6

P312

Cubo para hielo con disco separador /
Ice bucket with separative disk /
Seau à glaçons avec disque de séparation /
Eisbehälter mit Separationsscheibe

INOX - ST/STEEL
EDELSTAHL
18/10



REF	Ø cm	H cm	
P312.000	11	13	1

P974

Enfriador isotérmico (doble pared) /
Double wall insulated cooler /
Rafraîchisseur isotherme double paroi /
Doppelwändiger isothermischer Sektkühler



REF	Ø cm	H cm	
P974.000	10,5	20	1

P310 Cubitera tipo ensaladera / Ice cube bowl / Vasque / Eiskühler Schale-Form



REF	Ø cm	H cm	Lts	
P310.000	40	24,5	13,00	1

P327 Cubitera tipo ensaladera / Ice cube bowl / Vasque / Eiskühler Schale-Form



REF	Ø cm	H cm	Lts	
P327.000	35	25	10,00	1

P3110 Pie con portacubos acero inox / St/Steel bucket-holder stand / Pied porte-seau / Kühlerhalter mit Fuss rostfreier Stahl



REF	Ø cm	H cm	
P311.004*	18	67,5	1
P311.020**	22	69,0	1

*
Compatible con los modelos
Suitable for references
Adaptable pour les références
Geeignet für Modelle
P311.F2, P311.F6, P311.F71

**
Para cubitera 2 botellas / For 2 bottles bucket /
Pour seau à champagne deux bouteilles /
Für Kühler 2 Flaschen

Compatible con todos los modelos de cubos champán
Suitable with all champagne bucket models
Adaptable pour tous les modèles de seau à champagne
Geeignet für alle Modelle der Campagnerkühler

COCTELERIA / COCKTAIL SERVICE / COCKTAIL / COCKTAIL-SERVICE



P330 Coctelera / Shaker / Shakers Cocktail / Shaker



REF	H cm	Lts	
P330.035	18,0	0,35	1
P330.050	20,5	0,50	1
P330.070	23,5	0,70	1

47612 Coctelera / Shaker / Shakers Cocktail / Shaker

INOX - ST/STEEL
EDELSTAHL



Pulido brillante. La tapa se quita fácilmente.
Mirror finished. Crimped top removes easily.
Polissage brillant. La partie supérieure gaufrée se retire facilement.
Hochglanzpolierter. Der eingefasste Deckel lässt sich ganz einfach abnehmen.

REF	L	Ø cm	H cm	
47612	0,71	8,9	22,3	5

IDEA!

Tamaño pequeño perfecto para servicio individual.
Small size perfect for individual service.
Petite taille parfaite pour un service individuel.
Kleine Größe, perfekt für den Einzelservice.

46793 Coctelera / Shaker / Shakers Cocktail / Shaker



Acero inoxidable brillante. Bases reforzadas /
Acier inoxydable ultra-brillant. Bases renforcées /
Mirror-finished stainless steel. Reinforced bases /
Glänzender Edelstahl. Verstärkte Böden

REF	Ø cm	H cm	ml	
46793	9,2	17,8	887,20	12
46791	8,64	11,4	443,60	12

VER PRODUCTOS EN / SEE PRODUCTS ON /
VOIR PRODUITS EN PAGE / SIEHE PRODUKTE IN

TORQ
2.0



P. 316

P388 Pinza hielo / Ice tong /
Pince à glace / Eiszange



REF	L cm	
P388.018	18,5	12

47104 Pinza hielo / Ice tong /
Pince à glace / Eiszange



REF	L cm	
47104	15,9	12

P3181 Colador gusanillo / Cocktail strainer /
Passoire à cocktail / Cocktailsieb



REF	Ø cm	cm	
P318.100	7,6	11,7 x 15	12

P616 Exprime limones / Lemon squeezer /
Presse citron / Zitronenpresse



REF	Ø cm	
P616.000	17	1

P319 Cuchara batidora / Cocktail spoon /
Cuillère à cocktail / Mixerlöffel

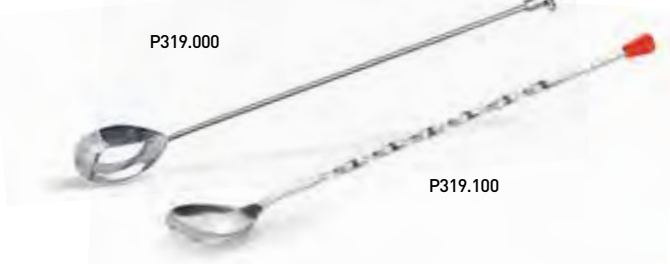

REF	L cm	
P319.000	26,5	1
P319.100	28,0	12

P399 Dosificador licor / Jigger /
Mesure à cocktail / Messbecher



REF	Ø cm	H cm	ml	
P399.000	A 3,7	A 2,8	25	1
	B 4,1	B 5,7	50	

VER PRODUCTOS EN / SEE PRODUCTS ON / VOIR PRODUITS EN PAGE / SIEHE PRODUKTE IN

TABLAS DE CORTE /
CUTTING BOARDS /
PLANCHES À DÉCOUPER /
SCHNEIDBRETTER

P. 138





P26100 Alfombra de bar para escurrido de copas / Bar mat /
Tapis égouttoir pour verres / Thekenabtropfmatten



Se pueden conectar unas con otras formando mayores superficies /
They can be connected with each other forming bigger surfaces /
Avec système de liaison pour composer une surface plus grande /
Für grössere Flächen kann man diese Matten mit anderen verbinden.

REF	cm	
P26.100	30 x 30 x 1,20	1



2331 Alfombra bar rectangular / Service mat / Tapis de service / Serviermatte



REF	cm	
2331-99	45,7 x 30,5 x 1,3	6

Caucho termoplástico flexible /
Flexible thermoplastic rubber /
Caoutchouc thermoplastique flexible /
Flexibles Thermoplast-Gummimaterial

4741-06 Caja condimentos negra / Condiment Bar Dispenser. Black /
Boîte à condiments / Cocktail Zutaten Spender

PLÁSTICO /
PLASTIC



4741-06



4743-06

REF	cm	Lts	COMPART.	
4741-06	30,5 x 15,2 x 11,4	1,9	4	1
4743-06	45,7 x 15,2 x 15,6	2,8	6	1

- Diseño contemporáneo.
- No aptos para lavavajillas.
- Tapa policarbonato transparente con cierre automático.
- El diseño de la tapa aumenta la capacidad y permite llenar el artículo.
- Las tapas con orificios permiten mantener el utensilio dentro con la tapa cerrada.
- Las placas enfriadoras se colocan en la parte inferior, manteniendo los condimentos fríos.

- Self-closing lid
- Positive stacking
- Reduces contamination
- Refreezable bottles fit under inserts keeping condiments cool and fresh longer
- Not recommended for dishwashers
- Clear polycarbonate lid for easy viewing
- Domed design increases capacity and allows for overfill

- Couvercle à fermeture automatique.
- Design contemporain.
- Empilage positif.
- Réduit la contamination.
- Les flacons recongelables tiennent sous des inserts, gardant les condiments au frais plus longtemps.
- Lave-vaisselle déconseillé.
- Couvercle en polycarbonate transparent pour voir plus facilement le contenu.
- La forme en dôme accroît la capacité et permet le remplissage au-dessus du bord.
- Les couvercles crantés vous permettent de maintenir les cuillères en place avec le couvercle fermé.

- Deckel mit automatischer Schließung.
- Zeitgenössisches Design.
- Positive Stapelnasen.
- Reduziert Verschmutzung Die Kühlplatten passen unter die Behälter, so dass die Gewürze längere Zeit kalt und frisch gehalten werden.
- Nicht spülmaschinenfest
- Transparenter Polycarbonatdeckel für gute Sichtbarkeit
- Das Haubendesign erhöht die Kapazität und erlaubt das Vollfüllen der Einheit
- Durch die Deckel mit Kerben bleiben die Löffel bei geschlossenem Deckel an ihrem Platz.

4747 Placa enfriadora para caja condimentos / Refreezable bottle for condiment holder /
Plaque réfrigérante pour Boîte à condiments / Kühlakku



REF	cm	
4747	13,2 x 11,4 x 2,9	6

P3994 Caja condimentos / Condiment holder / Boîte à condiment / Gewürzkiste

INOX - ST/STEEL
EDELSTAHL
18/10



REF	cm	H cm	L / COMPART.	
P399.400	30 x 14	8,5	0,45 x 4	1
P399.500	38 x 14	8,5	0,45 x 5	1
P399.600	45 x 14	8,5	0,45 x 6	1



47609 Tapón vacío botella / Vacuum Wine Saver/Stopper /
Bouchon pour bouteille de vin /préservation sous vide/ Weinflaschen-Vakuumverschluss



REF	cm	
47609	10,2 x 4,4	6

Permite almacenar la botella verticalmente y horizontalmente.
Crea un sello al vacío. Manteniendo la calidad del vino.

Allows for upright or horizontal storage.
Creates vacuum seal. Maintains wine quality.

Permet un stockage à la verticale ou à l'horizontale.
Crée un vide étanche. Maintient la qualité du vin.

Erlaubt vertikale und horizontale Lagerung.
Generiert ein Vakuumsiegel. Erhält die Weinqualität.

46774 Tapón botella champan / Champagne Stopper /
Bouchon de champagne / Sektflaschenverschluss



Posición abierta
Open position
Position ouverte
Offene Stellung



Posición cerrada
Closed position
Position fermée
Geschlossene Stellung



REF	cm	
46774	6,7 x 4,8 x 3,8	12 [2 x pack.]

Proporciona un sellado hermético.
Provides a hermetic seal.

Offre une fermeture hermétique.

Einzigartiger PVC-Innenstopper erlaubt starke Versiegelung und verlängert die Lebensdauer des Weins.

P985 Tapón botella / Bottle stopper / Bouchon bouteille / Flaschenverschluss



REF	Ø cm	H cm	
P985.000	3	5,5	1

P983 Anillo anti-goteo /
Ring stop drop /
Stop gouttes /
Antitropfring



REF	Ø cm	H cm	
P983.000	4	2	1

P9845 Sacacorchos de pared /
Wall-mounted corkscrew/
Tire-bouchon mur /
Korkenzieher Wandmontage



REF	cm	
P984.500	8 x 26 x 32	1

47602 Sacacorchos camarero Pulltap's™ /
Tire-bouchon de serveur Pulltap's™ /
Pulltap's™ Kellnermesser /
Pulltap's® Waiter's Corkscrew

PATENTED

Palanca doble /
Double lever /
Double levier /
Müheloser Korkenzieher



REF	ESPIRAL / SPIRALE cm	L cm	
47602	5,1	11,7	10

Acero forjado revestido de Teflon®. Hoja de corte interior.
Five turn Teflon® coated forged steel.
Acier forgé revêtu de Teflon® cinq tours.
Geschmiedeter Stahl mit fünfmaliger Teflon®-Beschichtung.

P984 Sacacorchos doble palanca /
Double-lever corkscrew /
Tire-bouchon double levier /
Doppelflüglicher Korkenzieher



REF	cm	
P984.100	17 x 6	12

P619 Bandeja camarero en acero inox /St/Steel round serving tray /
Plateau limonadier en acier inox / Servicetablett aus Rostfreiem Stahl



REF	Ø cm	
P619.002	35	1
P619.000	40	1

Pulido brillante /
Mirror finished /
Polissage brillant /
Glänzend poliert

1474 Bandeja camarero antideslizante / Non-Skid Trays /
Plateaux antidérapants / Rutschfeste Tablett



REF	Ø cm	
1474-0606	35,6	12
1476-0606	40,6	12

Antideslizante / Non-slip /
Antidérapant / Rutschfeste

Negro / Black /
Noir / Schwarz

P956 Bandeja de camarero antideslizante / Non slip serving tray /
Plateau de service anti-dérapant / Servicetablett Antirutschbeschichtung

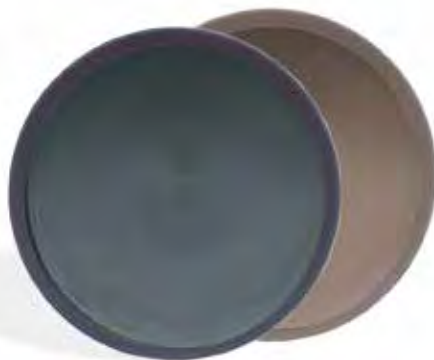

REF		Ø cm	
P956.035		35	1
P956.040		40	1
P956.135		35	1
P956.140		40	1

Color Negro i marrón /
Black and brown colour /
Couleur noir i marron /
Farben Schwarz und Braun

1612 Mantel anti deslizante / Anti-Skid Mat Tray Accessories / Tapis antidérapant / Rutschfeste Matte



REF	cm	
1612-06	41 x 31,8	12

Negro / Black /
Noir / Schwarz

3616 Botella bar / Bar keep / Bouteille de bar / Barflasche

REF	L	cm	
3616	0,47	25,7 x 9,20	1
3632	0,95	34,0 x 9,50	1
3648	1,40	38,1 x 16,5	1
3664	1,90	34,90 x 12,7	1
3628	3,80	43,2 x 14,0	1



El juego incluye 1 cuello, 1 jarra, 1 tapa y 6 picos estándar de diversos colores.

Includes 1 neck, 1 jar, 1 lid and 6 assorted colored spouts.

Le kit comprend 1 goulot, 1 bombonne, 1 couvercle et un assortiment de 6 becs verseurs standard de couleur.

Kit-Inhalt: 1 Halsteil 1 Gefäß, 1 Deckel und 6 Standardausgüsse in verschiedenen Farben.

VER PRODUCTOS EN / SEE PRODUCTS ON / VOIR PRODUITS EN PAGE / SIEHE PRODUKTE IN

**BANDEJAS DE POLIPROPILENO PARA COMIDA RÁPIDA /
POLYPROPYLENE FAST FOOD TRAYS /
PLATEAUX DE RESTAURATION RAPIDE EN POLYPROPYLENE /
POLYPROPYLEN - IMBISSTABLETTS**

P. 541



P8920B Lechera blanca / White creamer / Crème blanche / Milchkanne weiß



REF	Lts	
P892.015B	0,15	1
P892.035B	0,35	1
P892.060B	0,60	1

P8920N Lechera negra / Black creamer / Crème noir / Milchkanne schwarz



REF	Lts	
P892.015N	0,15	1
P892.035N	0,35	1
P892.060N	0,60	1

P8920R Lechera roja / Red creamer / Crème rouge / Milchkanne rot



REF	Lts	
P892.015R	0,15	1
P892.035R	0,35	1
P892.060R	0,60	1



P890 Tetera / Tea pot with filter / Théière / Teekanne



REF	Lts	
P890.125	0,15	1
P890.025	0,25	1
P890.035	0,35	1
P890.060	0,60	1

P891 Cafetera / Coffee pot with filter / Cafetière / Kaffeekanne



REF	Lts	
P891.035	0,35	1
P891.060	0,60	1
P891.100	1,00	1
P891.150	1,50	1

P892 Lechera / Creamer / Crémère / Milchkanne



REF	Lts	
P892.015	0,15	1
P892.025	0,25	1
P892.035	0,35	1
P892.060	0,60	1
P892.100	1,00	1
P892.150	1,50	1
P892.200	2,00	1

P893 Azucarero con tapa / Sugar bowl with lid / Sucrier avec couvercle / Zuckerdose mit Deckel



REF	Lts	
P893.025	0,25	1
P893.035	0,35	1



P885 Tetera / Tea pot with filter / Théière / Teekanne

	REF	Lts	
	P885.025	0,25	1
	P885.040	0,40	1
	P885.060	0,60	1

P886 Cafetera / Coffee pot with filter / Cafetière / Kaffeekanne

	REF	Lts	
	P886.035	0,35	1
	P886.060	0,60	1



P887 Lechera / Creamer / Crémère / Milchkanne

	REF	Lts	
	P887.015*	0,15	1
	P887.025*	0,25	1
	P887.035	0,35	1
	P887.060	0,60	1
	P887.100	1,00	1

* Diseño especial asas refs. P887.015 y P887.025 para facilitar el manejo / Special handle design for refs. P887015 and P887025 for a better handling.
Spécial design pour anses ref. P887.015 et P887.025 pour améliorer la prise en main / Spezielles Griffdesign für Art. P887.015 und P887.025 für die einfache Handhabung.

ATLANTIS

P880 Tetera / Tea pot with filter / Théière / Teekanne

	REF	Lts	
	P880.020	0,20	1
	P880.035	0,35	1
	P880.050	0,50	1

P881 Cafetera / Coffee pot with filter / Cafetière / Kaffeekanne

	REF	Lts	
	P881.100	1,00	1
	P881.175	1,75	1

P882 Lechera / Creamer / Crémère / Milchkanne

	REF	Lts	
	P882.015	0,15	1
	P882.035	0,35	1
	P882.050	0,50	1
	P882.100	1,00	1

P23003/
P23004 Tetera "Japón" / "Japan" tea pot /
Théière "Japon" / Teekanne "Japan"

Hierro fundido.
Esmaltado interior.
Con filtro de acero
inoxidable.



Cast iron.
Enameled inside.
With St/Steel filter.

Fonte en fer. Intérieur
émaillé. Avec filtre en
acier inoxydable.

Gusseisen.
Innen emailiert.
Mit Edelstahlfilter.



REF	FILTRO / FILTER / FILTRE / FILTER Ø cm	Lts	
P23.003	7,0	0,35	1
P23.004	8,0	0,80	12

P23008/
P23009 Tetera "Nipón" / "Nipón" tea pot /
Théière "Nipón" / Teekanne "Nipón"

Hierro fundido.
Esmaltado interior.
Con filtro de acero
inoxidable.



Cast iron.
Enameled inside.
With St/Steel filter.

Fonte en fer. Intérieur
émaillé. Avec filtre en
acier inoxydable.

Gusseisen.
Innen emailiert.
Mit Edelstahlfilter.



REF	FILTRO / FILTER / FILTRE / FILTER Ø cm	Lts	
P23.008	7,0	0,30	1
P23.009	8,0	0,60	12

P23010 Tetera "Asia" / "Asia" tea pot /
Théière "Asia" / Teekanne "Asia"

Hierro fundido.
Esmaltado interior.
Con filtro de acero
inoxidable.



Cast iron.
Enameled inside.
With St/Steel filter.

Fonte en fer. Intérieur
émaillé. Avec filtre en
acier inoxydable.

Gusseisen.
Innen emailiert.
Mit Edelstahlfilter.



REF	FILTRO / FILTER / FILTRE / FILTER Ø cm	Lts	
P23.010	6,3	0,40	1

P23015 Tetera "Kenya" / "Kenya" tea pot /
Théière "Kenya" / Teekanne "Kenya"

Hierro fundido.
Esmaltado interior.
Con filtro de acero
inoxidable.



Cast iron.
Enameled inside.
With St/Steel filter.

Fonte en fer. Intérieur
émaillé. Avec filtre en
acier inoxydable.

Gusseisen.
Innen emailiert.
Mit Edelstahlfilter.



REF	FILTRO / FILTER / FILTRE / FILTER Ø cm	Lts	
P23.015	7,0	0,30	1

Jarra para infusiones /
Coffee maker - herbal tea jug /
Pot à infusions /
Kaffee- und Teemacher

P896

 +100°C

Para sacar el cristal es
necesario desatornillar.
To remove the glass it is
necessary to unscrew.
Pour enlever le verre il est
nécessaire de dévisser.
Abschrauben notwendig
um das Glas zu entfernen.



REF	Lts	
P896.003	0,35	1
P896.008	0,80	1

Colador bola infusiones /
Tea infusion mesh /
Infuseur à thé /
Teesieb

P8965



REF	Ø cm	
P896.500	4,5	12

SERVICIO DE BEBIDAS /
 BEVERAGE SERVICE /
 SERVICE À BOISSONS /
 GETRÄNKE-SERVICE



P898 Jarra termo / Thermo jug / Piche isotherme / Thermoskanne



REF	COLOR/COLOUR	Lts	
P898.001		1,0	1
P898.002		1,0	1

P896 Termo inox con dosificador / Airpot thermo inox with feeder /
 Verseuse à pompe thermo inox / Thermoskanne mit Spender



REF	Lts	
P896.001	1,9	1
P896.002	3,0	1

P337 Jarra termo luxe / Luxe insulated coffee pot /
Pichet isolante luxe / Luxus Thermoskanne



REF	Lts	
P337.030	0,30	1
P337.060	0,60	1
P337.090	0,90	1
P337.150	1,50	1
P337.200	2,00	1

Interior en acero inoxidable
Inner side in St/Steel
Interieur en acier inoxydable
Innen aus rostfreiem Stahl

IDEA! Ideal para lavavajillas.
Ideal for dishwasher.
Ideal pour lave-vaisselle.
Ideal für spülmaschinengeeignet.

P895 Servidor termo / Vacuum jug /
Verseuse thermo / Servierthermoskanne

Interior en acero inoxidable
Inner side in St/Steel
Interieur en acier inoxydable
Innen aus rostfreiem Stahl



P895.006



REF	Lts	
P895.006	0,60	1
P895.010	1,00	1
P895.015	1,50	1
P895.020	2,00	1

P894 Termo con dosificador / Air pot /
Verseuse à pompe / Thermoskanne mit Spender

Base rotativa.
Rotative base.
Fond rotatif.
Drehbare Basis.



REF	Lts	
P894.003	3,00	1
P894.004	4,00	1
P894.005	5,00	1

SWIRLSERVE®

52122 Servidor termo Hot-N-Cold / Hot-N-Cold /
Piche isotherme Hot-N-Cold / Heiss-und kaltgetränke-Servierkannen

Aspecto cerámico /
Looks like porcelain /
Ressemble à de la porcelaine /
Die Außenseite sieht zwar wie Porzellan



REF	COLOR/COLOUR	ml	
52172		591	12
52162		591	12
52170		1.242	12
52160		1.242	12
52174		1.892	6
52164		1.892	6



Con pestañas de color naranja,
marrón o blanca que permiten
diferenciar fácilmente.

With orange, brown,
and white tabs allow
easy differentiation.

Avec pousoirs orange, marron
ou blanc pour une meilleure
différenciation

Mit orange, Braun und
Weiss Marke für bessere
Differenzierung

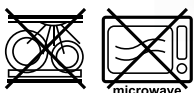



P335 Jarra bombada con retén /
Server without lid /
Pichet bombé avec retenu /
Thermoskanne mit Reserve

INOX - ST/STEEL
EDELSTAHL



REF	Lts	
P335.002	1,80	1

P6464 Jarra / Server /
Pichets / Karaffe



Tubo para hielo
Tube for ice
Tube pour les glaçons
Rohr für Eis

IDEA!

Ideal para zumos.
Ideal for juices.
Idéal pour le jus.
Ideal für Säfte.

REF	Lts	
P646.400	1,9	1

6000 Jarra de policarbonato / Deluxe clear pitcher /
Pichet Deluxe / Deluxe Wasserkaraffe



REF	H cm	Lts	
6000-13	23,5 x 13	1,8	12

Policarbonato. Control de vertido con agarre para el pulgar /
Virtually unbreakable polycarbonate. Thumb grip pour control /
Polycarbonate quasi-incassable. Versement maîtrisé avec l'appui-pouce /
Praktisch unzerbrechliches. Polycarbonat Ausgusskontrolle per Daumengriff

P649 Jarra agua tritan / Carafe tritan /
Carafe en tritan / Karaffe Tritan



EXCLUSIVE



REF	Lts	
P649.050	0,60	1
P649.100	1,00	1

Fabricado en Tritan /
Made of Tritan /
Fabriquée en Tritan /
Hergestellt aus Tritan

P6442 Jarra / Server /
Pichets / Karaffe



+80°C

Fabricada en SAN.
Made of SAN.
Fabriquée en SAN.
Hergestellt in SAN.



EXCLUSIVE

P6441 Jarra de policarbonato /
Polycarbonate server /
Pichet en polycarbonate /
Karaffe aus Polycarbonat



REF	Lts	
P644.200	1,00	1
P644.240	1,40	1
P644.275	1,75	1

REF	Lts	
P644.100	1,00	1
P644.175	1,75	1

P646 Jarra policarbonato apilable sin tapa / Stackable polycarbonate server without lid /
Pichet polycarbonate Empilable sans couvercle / Karaffe aus Polycarbonat ohne Deckel



REF		Lts	
P646.100		1,00	1
P646.103		1,00	1
P646.105		1,00	1
P646.200		2,00	1

P6463 Tapa polipropileno para jarra apilable / Polypropylene lid for stackable Server /
Couvercle polypropylène pour pichet empilable / Polycarbonat Deckel für Karaffe



REF		Lts	
P646.300		1,00	1
P646.310		1,00	1
P646.301		2,00	1

Para Jarra policarbonato apilable sin tapa P646.
Fits only on the Stackable polycarbonate servers P646.
Adaptables uniquement sur les pichets polycarbonate empilables P646.
Passt nur auf Polycarbonat Karaffe P646.



Quick Service Restaurant (QSR)
COLECTIVIDADES /
INSTITUTIONS /
COLLECTIVITÉS /
GEMEINSCHAFTSVERPFLEGUNG

15.1 LIDSAVERS
DISPENSADOR DE TAPAS / LID DISPENSER /
DISTRIBUTEUR DE COUVERCLE / DECKELSPENDER 534

15.2 AUTOSERVICIO / SELF-SERVICE /
SERVICE DE QUALITÉ / SELFSERVICE 540

15.3 HOSPITALES Y COLECTIVIDADES / HOSPITALS AND
INSTITUTIONS / HÔPITAUX ET COLLECTIVITÉS /
KRANKENHÄUSER UND GEMEINSCHAFTSVERPFLEGUNG 544

15.4 DELIVERY BAGS 546

Beneficios para los clientes

- Un ambiente agradable, limpio y ordenado
- Un servicio notablemente más higiénico fomenta la buena voluntad de los clientes
- El diseño fácil de usar permite a los clientes llenar bebidas y poner la tapa usando una sola mano.

Customer Benefits

- A welcome environment that is clean and tidy
- Noticeably more hygienic service fosters customer goodwill
- Simple-to-use design allows customers to fill beverages and put on a lid using only one hand

Avantages pour le client

- Un cadre accueillant, propre et ordonné.
- Un service de toute évidence plus hygiénique dope les ventes.
- Utilisation simple et facile qui permet aux clients de remplir leur gobelet de boisson et de mettre le couvercle d'une seule main.

Vorteile für den Kunden

- Eine einladende Umgebung, die sauber und ordentlich ist
- Die weitaus hygienischere Präsentation spricht die Kunden unmittelbar an
- Dank des einfach zu verwendenden Designs kann der Kunde mit nur einer Hand den Becher füllen und den Deckel aufsetzen.



AHORRAR HASTA UN 30% DE LOS COSTES / UP TO 30% COST SAVINGS / ÉCONOMISEUR DE 30% DES COÛTS / 30% KOSTENEINSPARUNG

Ahorros

- Menos pérdidas de tapas significan más ahorro.
- Los mostradores se mantienen libres de pilas de tapas nuevas y tapas rechazadas, desordenadas, lo cual se traduce en menos trabajo de limpieza.

Cost Savings

- Fewer wasted lids adds up to more savings
- Counters are kept free of stacks of new lids and messy rejected lids, requiring less labor for cleanup

Économies

- Moins de couvercles gaspillés, ce qui se traduit par plus d'économies.
- Les comptoirs ne sont pas encombrés par des piles de couvercles neufs et des couvercles usagés et sales, ce qui demande moins de main-d'oeuvre pour le nettoyage.

Einsparungen

- Weniger verschwendete Deckel bedeuten reduzierte Kosten.
- Auf den Tischplatten sammeln sich keine herumliegenden neuen und gebrauchten Deckel an, sodass sie mit weniger Aufwand sauber gemacht werden können.





**Montaje / Assembly /
Montage / Montage**

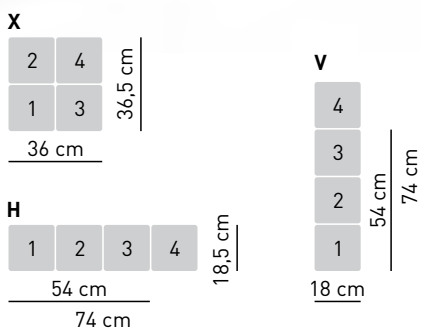

T1 (L)

Tapas / Lids / Couvertres / Deckels

LS02 G / LS02 H

MODELO / MODEL	CÓDIGO / CODE
Berry™ DLT1310 Domed	AB
Berry™ DLT1310SS	AC
Berry™ DLT1402 Domed	AD
Berry™ DLT1402SS	AE
Berry™ DLT1408 Domed	AF
Berry™ DLT1408SS	AG
Dart® 16EL	AJ
Dart® 16LCDH	AK
Dart® 16RCL	AL
Dart® 16SL	AM
Dart® 20SL	AN
Dart® 20SLR	AO
Dart® 32SL	AP
Dart® 32SLR	AQ
Dixie® 9542	AR
Dixie® 955	JY
Dixie® TP9542	AS
Dixie® TP9550	JZ
International Paper LCRS 32	AT
International Paper LCTS 44	AU
Sweetheart® LGX12R	AY
Solo® 626	AZ
Solo® DL626	BB
Solo® DLR642	BC
Solo® LD16A	BD

T2 (C)

**Dispensador vaso /
Cup dispenser /
Distributeur de gobelets /
Becherspender**

REF	CÓDIGO / CODE	TIPO / TYPE
INC-80	A	Plástico / Plastic / Plastique / Plastik
CADJ-3	D	Inox / St/Steel / Rostfreier Stahl

T3 (S)

**Dispensador cañas /
Straw dispenser /
Distributeur de pailles /
Strohhalmspender**

REF	CÓDIGO / CODE
S1	S

T4 (P)

**Apartado para condimentos /
Condiment pocket /
Casier à condiments /
Gewürzfach**

REF	CÓDIGO / CODE
P1	P

Para otros modelos de tapa, consultar a su comercial.
For other lid models, consult your dealer.
Pour d'autres modèles de couvercles, consulter votre agent.
Für andere Modelle mit Deckel, fragen Sie Ihren Händler.

**LS02 G Mueble dispensador tapas y vasos / Lids and cups dispenser display /
Meuble distributeur couvercles et gobelets / Deckel- und Becherspender**



REF + TYPE + CODE
G4V-LLCC-AB-AD-A-A

REF	TIPO / TYPE	CÓDIGO / CODE
G1	L	T1
G2H	LL	T1 + T1
G2V	LC	T1 + T2
	LP	T1 + T4
G3H	LLL	T1 + T1 + T1
	LCC	T1 + T2 + T2
G3V	LCS	T1 + T2 + T3
	LCP	T1 + T2 + T4
G4H	LCCC	T1 + T2 + T2 + T2
	LCCS	T1 + T2 + T2 + T3
G4V	LCCP	T1 + T2 + T2 + T4
	LLCC	T1 + T1 + T2 + T2
G4X	LCCC	T1 + T2 + T2 + T2
	LCCS	T1 + T2 + T2 + T3
	LCCP	T1 + T2 + T2 + T4
	LLCC	T1 + T1 + T2 + T2

**LS02 H Mueble dispensador tapas vertical / Vertical lids dispenser display /
Meuble distributeur couvercles vertical / Vertikaler Deckelspender**



REF + CODE
H2V-LL-AB-AE

REF	CÓDIGO / CODE	H cm
H1-L	+T1	18,5
H2V-LL	+T1 + T1	36,5
H3V-LLL	+T1 + T1 + T1	54,0
H4V-4L	+T1 + T1 + T1 + T1	74,0

LS02 Dispensador encastrable tapas / Lids In-counter dispenser /
Distributeur encastrable couvercles / Einsetzbare Kabinett Deckels



REF + CODE
LS02IB-AB

L cm
16,5 cm
15 cm

REF	CÓDIGO / CODE	POSICIONES / POSITIONS / POSITIONS / POSITIONEN	L cm	Para / For / Pour / Für cm	
LS02IB	T1	H	58,5	8,3 - 10,2	1
LS02IVB	T1	V	58,5	8,3 - 10,2	1
LS02PB	T1	H	58,5	10,3 - 12,1	1
LS02PVB	T1	V	58,5	10,3 - 12,1	1
LS02IS18B	T1	H	45,5	8,3 - 10,2	1
LS02PS18B	T1	H	45,5	10,3 - 12,1	1

GDS Mueble dispensador tapas y vasos con organizador / Lids and cups dispenser organizer display /
Meuble distributeur couvercles et gobelets avec organisateur / Deckel- und Becherspender mit Organizer



REF + CODE
G2VLCCLDS-BD

REF + CODE
G1LLDS-AB

H cm
64 cm
17,5 cm

REF	CÓDIGO / CODE	H cm	
G1LLDS	T1	42,5	1
G2VLCCLDS	T1 + T2	60,5	1
G2VLLLDS	T1 + T1	60,5	1
G3VLCCLDS	T1 + T2 + T2	78,5	1

LS02 J Mueble dispensador mini tapas / Mini lid dispenser display /
Meuble distributeur mini couvercles / Kabinettmöbel Deckels Mini



H cm
55 cm
B cm

REF + TYPE + CODE
J2V-LL-M9-N1

REF	TIPO / TYPE	CÓDIGO / CODE	B x H cm
J1	L	T5	13,5 x 19,1
J2V	LL	T5 + T5	13,5 x 36,0
J2H	LL	T5 + T5	28,5 x 19,1
J3V	LLL	T5 + T5 + T5	13,5 x 52,5

LS02 M Dispensador encastrable mini tapas / Mini lid In-counter dispenser /
Distributeur encastrable mini couvercles / Einsetzbare Kabinett Deckels Mini



L cm
14,5 cm
12,5 cm

REF + CODE
LS02MS18B-M9

REF	CÓDIGO / CODE	POSICIONES / POSITIONS / POSITIONS / POSITIONEN	L cm	
LS02MS18B	T5	H	45,5	1
LS02MVS18B	T5	V	45,5	1

Para / For / Pour / Für: 4,4 - 8,3 cm

LIDSAVER™ 2 MINI

T5 (L)

Tapas / Lids / Couvercles / Deckels
LS02 J / LS02 M

TIPO / TYPE	CÓDIGO / CODE
Dart® Solo® P150	M9
Dart®/Solo® PL2	N1
Natureworks Inego PLA 3.085/.310	YQ
International Paper LCM-12S	D9
International Paper LCWS12	XE
International Paper LCRS 12	EQ
International Paper LHSL-8	XK
Pactiv YLP10C	ZD
Solo® L10BL	ST
Solo® PL4	ZN
Solo® TL3-8	IT
Solo®TLRN38	ZM
Sweetheart® DLX8R	GV
SUP-10D	YT
Quick 6 Oz. BIS-H	YH
WinCup® 6L STYROLID	VG

Para otros modelos de tapa, consultar a su comercial.

For other lid models, consult your dealer.

Pour d'autres modèles de couvercles, consulter votre agent.

Für andere Modelle mit Deckel, fragen Sie Ihren Händler.

INC / CADJ Dispensador vaso / Cup dispenser /
Distributeur de gobelets / Becherspender



REF	L cm	Ø cm	Para / For/ Pour / Für cm	
INC-80	58,5	13,5	5,7 - 12,1	1
INC-80S18	46,0	13,5	5,7 - 12,1	1
CADJ-1	56,0	13,5	6,4 - 8,9	1
CADJ-2	56,0	14,5	7,6 - 9,8	1
CADJ-3	56,0	17,5	7,6 - 11,7	1

RSCL Dispensador vasos y tapas / Lids and cups dispenser /
Distributeur gobelets et couvercles / Deckel- und Becherspender



REF	Ø cm	H cm	Para / For/ Pour / Für cm	
RSCL-4	38	101,5		1
LD2-2	11	65,0	10,5	1
LD3-2	13	65,0	12,4	1
PLC-1	8	65,5	5,7 - 7,3	1
PLC-2	9,5	65,5	7,3 - 8,9	1
PLC-3	11	65,5	8,9 - 10,5	1



PLC-1
PLC-2
PLC-3



RSCL-4



LD2-2
LD3-2

3825 Dispensador de cañas / Straw dispenser /
Distributeur de pailles / Strohhalmspender



3825-06



3821-06

REF	cm	H cm	Capacidad / capacity / capacité / Kapazität	Caña / Straw / Paille / Strohhalm		
				Ø mm	H cm	
3825-06	23 x 10	18	250	6-7	19 - 22	1
3821-06	32 x 14	18	250	7-8	23 - 30,5	1

CTNO Servilletero / Napkin holder / Porte-serviettes / Serviettenspender



CTNO-06



7512-06



6525-13

REF	cm	H cm	Capacidad / capacity / capacité / Kapazität	Servilletas / Napkin / Serviettes / Servietten cm	
CTNO-06*	24,5 x 49,0	38,5	100	12,5 x 16,5 / 11,5-12,5 x 16,5	1
7512-06	30,0 x 20,5	15,5	175	12,5 x 16,5 / 13,5 x 16,5	1
6525-13**	13,5 x 16,5		500	12,5 x 16,5 / 13,5 x 16,5	1

*Divisores ajustables / Adjustable dividers / Séparateurs réglables / Verstellbare Trenner

**Encastrable / Drop in / Encastrable / Einsetzbare

LDS Dispensador de condimentos / Condiment dispensers /
Distributeur de condiments / Beilagenspender



LDS-4CUP



CTC-3X2V

REF	cm	H cm	
LDS-4CUP*	29,5 x 53,5	51,5	1
CTC-3X2V**	29,0 x 27,0	41,5	1

*Para tapas y vasos / For lids and cups /
Pour couvercles et gobelets / Für Deckel und Becher:

Ø 12 cm

*Divisores ajustables / Adjustable dividers /
Séparateurs réglables / Verstellbare Trenner

4842 Dispensador auto-servicio / Self-Serve dispenser system /
Système distributeur libre-service / Spender zur Selbstbedienung



4842-06



4843-06



4804-06



4806-06

REF	cm	H cm	Para / For / Pour / Für REF.	
4842-06	14,5 x 40,5	35,5		1
4843-06	14,5 x 50,5	35,5		1
4804-06	13,0 x 20,5	11,5	4842-06	1
4806-06	13,0 x 28,5	11,0	4843-06	1

IDEA!

Ideal para cubiertos, te, condimentos, sal, pimienta y para todo tipo de productos de mucha rotación.
Ideal for flatware, tea, condiment packets, salt, pepper, and products with high-volume usage.
Idéal pour couverts, thé, condiments, sel, poivre et toute sorte de produits à usage intensif.
Ideal für Besteck, Tee, Gewürze, Salz, Pfeffer und alle Arten von oft verwendeten Produkten.

VER PRODUCTOS EN / SEE PRODUCTS ON / VOIR PRODUITS EN PAGE / SIEHE PRODUKTE IN

CARRO SELF-SERVICE DE ACERO INOXIDABLE PARA BANDEJAS DE ANCHO 365 MM HASTA 420 MM. POSIBILIDAD DE INCORPORAR PLAFONES LATERALES COMPOSITE-ALUMINIO /

SELF-SERVICE TROLLEY MADE OF ST/STEEL FOR TRAYS FROM 365 MM TO 420 MM WIDTH. AVAILABLE ALSO WITH TWO ALUMINIUM-COMPOSITE SIDE PANELS /

CHARIOT SELF-SERVICE EN ACIER INOXYDABLE POUR PLATEAUX DE 365 MM À 420 MM. DISPONIBLE AUSSI AVEC DEUX PANNEAUX LATÉRAUX EN COMPOSITE-ALUMINIUM /

SELBSTBEDIENUNGSWAGEN AUS ROSTFREIEM STAHL FÜR TABLETTS DER BREITE 365 MM BIS 420 MM. DAS EINSETZEN VON SEITLICHEN ALUMINIUM-COMPOSIT WÄNDEN IST MÖGLICH.

P. 209

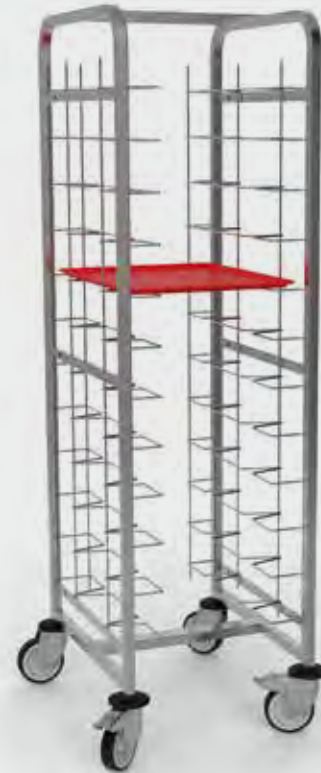

VER PRODUCTOS EN / SEE PRODUCTS ON / VOIR PRODUITS EN PAGE / SIEHE PRODUKTE IN

CARRO DOBLE PARA BANDEJAS FAST-FOOD 12 GUÍAS / DOUBLE FAST-FOOD TRAY TROLLEY 12 RAILS /
CHARIOT DOUBLE POUR PLATEAUX FAST-FOOD 12 GLISSIÈRES /
DOPPELWAGEN FÜR FAST-FOOD TABLETTS 12 EINSCHÜBE

P. 209



P8074 Carro porta - cubiertos y bandejas / Trays and cutlery dispenser trolley /
Chariot porte plateaux couverts / Besteck - und Tablettwagen



REF	mm	
P80.740	810 x 570 x 1.065	1

No incluye cubetas GN 1/3 ni bandejas.
Without 1/3 GN containers and trays.
Bacs GN 1/3 et plateaux pas inclus.
Behälter GN 1/3 und Tablett nicht inklusive.

Disponible también con ruedas poliamida. Consultar precio.
Available also on polyamide castors. Please ask for price.
Disponible aussi avec roulettes polyamide. Consulter prix.
Auch lieferbar mit Polyamidrädern. Bitte fragen Sie nach dem Preis.

P8610 Bandeja fast - food fibra de vidrio / Fiberglass fast - food tray /
Plateau fast food fibre de verre / Fiberglas fast - food Tablett



REF	mm	
P861.045	455 x 355	12
P861.053	530 x 325	12

Color gris / Grey color / Couleur gris / Farbe grau.

86100 Bandejas de polipropileno para comida rápida / Polypropylene Fast Food Trays /
Plateaux de restauration rapide en polypropylene / Polypropylen - Imbissttablets



+ 86 °C

Reciclable/
Recyclable/
Recyclable/
Recyclingfähig



REF		cm	
86100		25,4 x 35,6	24
86101		25,4 x 35,6	24
86103		25,4 x 35,6	24
86104		25,4 x 35,6	24
86105		25,4 x 35,6	24
86106		25,4 x 35,6	24
86107		25,4 x 35,6	24
86108		25,4 x 35,6	24
86109		25,4 x 35,6	24
86110		30,5 x 40,6	24
86111		30,5 x 40,6	24
86113		30,5 x 40,6	24
86114		30,5 x 40,6	24
86115		30,5 x 40,6	24
86116		30,5 x 40,6	24
86117		30,5 x 40,6	24
86118		30,5 x 40,6	24
86119		30,5 x 40,6	24
86120		35,6 x 45,7	12
86121		35,6 x 45,7	12
86123		35,6 x 45,7	12
86124		35,6 x 45,7	12
86125		35,6 x 45,7	12
86126		35,6 x 45,7	12
86127		35,6 x 45,7	12
86128		35,6 x 45,7	12
86129		35,6 x 45,7	12

El borde grueso reforzado con acanalados en las esquinas añade resistencia a los impactos. Cuatro cuñas de apilado para secar rápidamente y evitar que se peguen entre sí. Acabado texturizado entretejido semibrillante que aporta una superficie menos resbaladiza.

Thick reinforced rim with corner ribs add impact strength. Four stacking lugs speed drying and prevent sticking. Semi-gloss, weave-grain textured finish provides a reduced-slip surface.

Rebord reforcé épais avec nervures aux angles pour accroître la résistance aux chocs. Les quatre cales d'empilage accélèrent le séchage et empêchent les plateaux de coller entre eux. La texture tissée semi-brillante donne une surface moins glissante.

Dicker, verstärkter Rand mit Eckenrippen verbessert die Schlagfestigkeit. Vier Stapelnasen beschleunigen das Trocknen und verhindern ein Aneinanderhaften der Tablett. Texturierte Maserung erzeugt eine rutschbeständige Oberfläche.

P8070

Soporte para bandejas porta - cubiertos /
Counter - top cutlery dispenser /
Support porte - couverts /
Ständer für Besteckkasten



Compatible: REF. P900.000

No incluye bandeja portacubiertos / Cutterly bin not included /
Bac ramasse - couverts non inclus / Besteckkasten nicht inklusive

REF	mm	
P80.700	526 x 510 x 328	1

P8071

Soporte doble para bandejas porta - cubiertos /
Double counter - top cutlery dispenser /
Support double porte - couverts /
Doppelständer für Besteckkasten



Compatible: REF. P900.000

No incluye bandeja portacubiertos / Cutterly bin not included /
Bac ramasse - couverts non inclus / Besteckkasten nicht inklusive

REF	mm	
P80.710	526 x 510 x 580	1

P8072

Soporte para 4 cubetas GN 1/3 /
Counter - top dispenser for 4 GN containers 1/3 /
Support pour 4 bacs GN 1/3 /
Ständer für 4 Behälter GN 1/3



No incluyen cubetas GN / GN containers not included /
Bacs GN non inclus / GN Behälter nicht inklusive

REF	mm	
P80.720	738 x 310 x 430	1

P8073

Soporte para 8 cubetas GN 1/3 /
Counter - top dispenser for 8 GN containers 1/3 /
Support pour 8 bacs GN 1/3 /
Ständer für 8 Behälter GN 1/3



No incluyen cubetas GN / GN containers not included /
Bacs GN non inclus / GN Behälter nicht inklusive

REF	mm	
P80.730	738 x 465 x 600	1

P900

Bandeja porta - cubiertos gastronorm 1/1 /
1/1 gastronorm cutlery bin /
Bac ramasse - couverts gastronorme 1/1 /
Besteckkasten GN 1/1



Polipropileno alimentario / Food contact polypropylene /
Polypropylène alimentaire / Polypropylen geeignet für den Lebensmittelkontakt

REF	mm	
P900.000	530 x 325 x 100	1

P340

Bandeja auto - servicio acero inox /
St/steel self - service tray /
Plateau self - service acier inox /
Selbstbedienungstablett rostfreier Stahl



6 Compartimentos / 6 Compartments /
6 Compartiments / 6 Unterteilungen

REF	mm	H mm	
P340.000	460 x 285	20	1

VER PRODUCTOS EN / SEE PRODUCTS ON /
VOIR PRODUITS EN PAGE / SIEHE PRODUKTE IN

GASTRONORM INOX 18/10 /
18/10 ST/STEEL GASTRONORM /
GASTRONORME INOX 18/10 /
GASTRONORM EDELSTAHL 18/10



P. 156

VER PRODUCTOS EN / SEE PRODUCTS ON /
VOIR PRODUITS EN PAGE / SIEHE PRODUKTE IN

CESTAS PARA VAJILLA /
DISHWASHER RACKS /
CASIERS À VAISSELLE /
SPÜLMASCHINENKÖRBE



P. 182

VER PRODUCTOS EN / SEE PRODUCTS ON /
VOIR PRODUITS EN PAGE / SIEHE PRODUKTE IN

VIOLET COLLECTION



P. 104

VER PRODUCTOS EN / SEE PRODUCTS ON /
VOIR PRODUITS EN PAGE / SIEHE PRODUKTE IN

SPOODLE® MONOBLOC REDONDO /
ONE-PIECE ROUND SPOODLE® /
SPOODLE® MONOBLOC RONDE /
MONOBLOK RUNDSCHALEN SPOODLE®



P. 88

P919 Bandeja isotérmica / Isothermal tray /
Plateau Isotherme / Isothermisches Tablett



REF	mm	
P919.000	530 x 370 x 110	1

Fabricada en polipropileno con interior aislante de poliuretano. Sin CFC.
Made of polypropylene with insulating polyurethane without CFC interior.
Fabriqué en polypropylène avec intérieur de polyuréthane sans CFC.
Hergestellt aus Polypropylen mit Innenisolierung aus Polyurethan. Ohne CFC.

Adaptado para plato llano, hondo, bol, fuente rectangular en policarbonato, porcelana o melamina.
Suitable for flat plate, soup plate, bowl, salad bowl on polycarbonate, chinaware or melamine.
Apte pour assiettes plates, à soupe, bols, raviers, soit en polycarbonate, porcelaine ou melamine.
Geeignet für flache und tiefe Teller, Schüssel, rechteckige Schale aus Polycarbonat, Porzellan oder Melamin.

Complementos no incluidos / Complements not included /
Compléments non-inclus / Zubehör nicht inklusive

P920
Platos policarbonato /
Polycarbonate plates /
Assiettes en polycarbonate /
Polycarbonat Teller



Ref. 920.001

REF	Tipo / Type	Ø mm	H mm	
P920.001	Llano / Flat / Plat / Flach	206	29	1
P920.002	Hondo / Soup / À soupe / Tief	185	45	1
P920.003	Desayuno / Breakfast / Petit déjeuner / Frühstück	175	25	1

Apto para lavavajillas y microondas /
Dishwasher and microwave safe /
Utilisable au lave-vaisselle et micro-ondes /
Geeignet für Spülmaschinen und Mikrowellen

P922
Fuente rectangular policarbonato /
Polycarbonate rectangular bowl /
Ravier rectangulaire en polycarbonate /
Rechteckige Schale aus Polycarbonat



REF	mm	H mm	Lts	
P922.000	95 x 138	45	0,25	1
P922.100*	96 x 139	24		1

Apto para lavavajillas y microondas /
Dishwasher and microwave safe /
Utilisable au lave-vaisselle et micro-ondes /
Geeignet für Spülmaschinen und Mikrowellen

*Tapa rígida /
*Rigid lid /
*Couvercle rigide /
*Harter Deckel

P921
Bol doble pared policarbonato con tapa /
Double wall polycarbonate bowl with lid /
Bol polycarbonate double paroi avec couvercle /
Doppelwändige Schüssel aus Polycarbonat mit Deckel



REF	Ø mm	H mm	Lts	
P921.001	125	68	0,45	1

Apto para lavavajillas y microondas /
Dishwasher and microwave safe /
Utilisable au lave-vaisselle et micro-ondes /
Geeignet für Spülmaschinen und Mikrowellen

P923
Taza desayuno policarbonato /
Polycarbonate breakfast cup /
Tasse dessert polycarbonate /
Frühstückstasse aus Polycarbonat



REF	mm	H mm	Lts	
P923.000	94	68	0,325	1
P923.001*	100			1

Apto para lavavajillas y microondas /
Dishwasher and microwave safe /
Utilisable au lave-vaisselle et micro-ondes /
Geeignet für Spülmaschinen und Mikrowellen

*Tapa /
*Lid /
*Couvercle /
*Deckel

P924 Vaso policarbonato / Polycarbonate glass / Verre en polycarbonate / Polycarbonat Becher



REF	Color / Couleur	Ø mm	H mm	Lts	
P924.001		70	102	0,25	1
P924.002		70	70	0,17	1
P924.002A		70	70	0,17	1
P924.002R		70	70	0,17	1
P924.002V		70	70	0,17	1

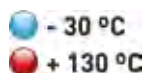

Apto para lavavajillas / Dishwasher safe
Utilisable au lave-vaisselle / Spülmaschinengeeignet

VER PRODUCTOS EN / SEE PRODUCTS ON / VOIR PRODUITS EN PAGE / SIEHE PRODUKTE IN

CARRO TRANSPORTE BANDEJAS /
TRAY TRANSPORT TROLLEY /
CHARIOT TRANSPORT PLATEAUX /
TRANSPORTWAGEN



P. 209

VER PRODUCTOS EN / SEE PRODUCTS ON / VOIR PRODUITS EN PAGE / SIEHE PRODUKTE IN

CESTA PARA BANDEJAS ISOTÉRMICAS, GN Y PLATOS /
GN, ISOTHERMAL TRAYS AND PLATES RACK /
PANIER POUR PLATEAUX ISOTHERMES, GN ET ASSIETTES /
SPÜLKORB FÜR ISOTHERMISCHE TABLETS, GN UND TELLER



P. 190

REPARTO Y TRANSPORTE DE ALIMENTOS / FOOD DELIVERY & TRANSPORT / TRANSPORT ET LIVRAISON D'ALIMENTS / AUSLIEFERUNG UND TRANSPORT VON LEBENSMITTELN

Responsables de la grandeza en el reparto /
Purveyors of delivery greatness /
Livreurs d'excellence /
Verantwortlich für die Größen in den Auslieferungen



BOLSAS PARA PIZZA, BANQUETERÍA, TIPO TORRE Y
MOCHILAS PARA REPARTO DE ALIMENTOS /

PIZZA, CATERING, TOWER BAGS AND
FOOD DELIVERY BACKPACK BAGS /

SACS À PIZZAS, DE TRAITEUR, SACS-TOURS
ET SACS À DOS DE LIVRAISON D'ALIMENTS /

PIZZATASCHEN, CATERINGTASCHEN,
HOHE TASCHEN UND RUCKSÄCKE FÜR
LEBENSMITTEL-AUSLIEFERUNG



SERIE 3

La pauta de referencia del ingenio térmico. La comida caliente genera calor en la bolsa mientras que el aislamiento de alto rendimiento ayuda a retenerlo, manteniendo la comida caliente y deliciosa.
INCLUYE: Bolsa

The baseline of warmth ingenuity. The hot food generates heat in the bag while the high performance insulation helps retain the heat, keeping food as warm as it is delicious.
INCLUDES: Bag

La référence en matière d'ingénierie. Les aliments chauds dégagent de la chaleur dans le sac tandis que l'isolant ultra-performant piège la chaleur, gardant les aliments aussi chauds que délicieux.
INCLUDES: Housse de transport

Das Paradebeispiel der Wärmetechnik. Das heiße Essen erwärmt die Tasche, während die stark isolierende Eigenschaft dazu beiträgt, die Wärme zu erhalten, damit das Essen warm und lecker bleibt.
ENTHÄLT: Tasche

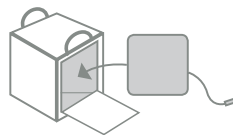

SERIE 5

El siguiente nivel en nuestra línea de bolsas de reparto incluye una almohadilla térmica que precalienta la bolsa. Coloque la comida caliente en la bolsa precalentada, desenchufe la almohadilla térmica y listo. O use el cable de alimentación opcional de 12 V en el automóvil para calentar continuamente la bolsa durante el transporte.
INCLUYE: Bolsa / Heat pad / Adaptador heat pad con enchufe
OPCIONAL: Cable conector coche 12V

The next step in our heating bag line features a heat pad that pre-heats the bag. Place your hot food into the pre-heated bag, unplug the heat pad and go. Or use the optional 12V in-car power cord to continually heat the bag during transport.
INCLUDES: Bag / Heat Pad / adaptor heat pad with plug
OPTIONAL: 12V In-car power cord

Le niveau supérieur dans notre ligne de sacs de livraison a un coussin chauffant qui préchauffe le sac. Placez vos aliments chauds dans le sac préchauffé, débranchez le coussin chauffant et partez faire votre livraison. Ou utilisez le câble d'alimentation 12V sur allume-cigares en option pour continuer à chauffer le sac en cours de transport.
INCLUDES: Housse de transport / Corps de chauffe / Adaptateur prise corps de chauffe.
OPTIONAL: Cordon d'alimentation 12V de voiture

ENTHÄLT: Tasche / Wärmekissen / adapter wärmekissen mit stecker
OPTIONAL: 12V auto stromkabel

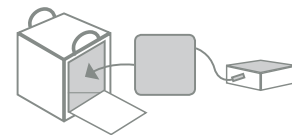

SERIE 5P

Optimice la temperatura de la bolsa, la calidad el alimento y el margen de reparto. Seleccione la temperatura, precaliente la bolsa y caliéntela continuamente durante el transporte. Use el cargador de 12 V incluido en el automóvil para recargar la batería de iones de litio entre los repartos.
INCLUYE: Bolsa / Heat pad / Adaptador heat pad con enchufe / Batería / Cable conector coche 12V

Optimize bag temperature, food quality, and delivery range. Select the temperature, pre-heat the bag, and continually heat the bag during transport. Use the included 12V in-car charge to recharge the lithium ion battery power pack in between deliveries.
INCLUDES: Bag / Heat pad / Adaptor heat pad with plug / Battery / 12V In-car power cord

Optimisez la température du sac, la qualité des aliments et le rayon de livraison. Sélectionnez la température, préchauffez le sac et continuez à le chauffer en cours de transport. Utilisez le chargeur en voiture 12V pour recharger le bloc-pile lithium-ion entre deux livraisons.
INCLUDES: Housse de transport / Corps de chauffe / Adaptateur prise corps de chauffe / Batterie / Cordon d'alimentation 12V de voiture

ENTHÄLT: Tasche / Wärmekissen / Adapter wärmekissen mit stecker / Batterie / 12V Auto stromkabel

CARCASA EXTERIOR RESISTENTE
A LA HUMEDAD /
MOISTURE-RESISTANT OUTER SHELL /
ENVELOPPE EXTÉRIEURE RÉSI-
STANT À L'HUMIDITÉ /
AUSSENGEHÄUSE RESISTENT GEGEN
FEUCHTIGKEIT

ASAS DE TRANSPORTE DE SERVICIO
PESADO PARA MAYOR RESISTENCIA Y
COMODIDAD /

HEAVY-DUTY HANDLES AND WEBBING
FOR STRENGTH AND COMFORT /

SANGLES DE TRANSPORT ULTRA-SOLIDES
POUR ROBUSTESSE ET CONFORT /

TRANSPORTGURTE FÜR SCHWERE
LIEFERUNGEN FÜR MEHR FESTIGKEIT
UND KOMFORT

ASAS DOBLES Y HOMBRE-
RAS MÁS LARGAS Y
RESISTENTES /

DOUBLE HANDLES AND LONGER,
HEAVY-DUTY SHOULDER STRAPS /

DOUBLES POIGNÉES ET BAND-
DOULIÈRES ROBUSTE PLUS
LONGUES /

DOPPELGRIFFE UND LÄNGERE
SCHULTERGURTE FÜR SCHWERE
LIEFERUNGEN



BASES RESISTENTES PARA GARANTIZAR LA
ESTABILIDAD DE LA CARGA Y EL TRANSPORTE /

SOLID FLOOR PANELS TO ENSURE STABILITY
FOR LOADING AND TRANSPORTATION /

FOND SOLIDE, GAGE DE STABILITÉ EN COURS
DE CHARGEMENT ET DE TRANSPORT /

FESTE BODENPLATTEN, UM BEIM VERLADEN
UND TRANSPORTIEREN FÜR MEHR STABILITÄT
ZU SORGEN

LAS BOLSAS Y LOS INSERTOS DE ALAMBRE
SE PLIEGAN FÁCILMENTE PARA UN
ALMACENAMIENTO COMPACTO /

BAGS & WIRE INSERTS FOLD EASILY FOR
COMPACT STORAGE /

LES SACS ET LES INSERTS MÉTALLIQUES SE
PLIENT FACILEMENT POUR UN RANGEMENT
COMPACT /

DIE TASCHEN UND DRAHT-EINSÄTZE LASSEN
SICH FÜR EINE KOMPAKTE AUFBEWAHRUNG
LEICHT ZUSAMMENFALTEN /



AISLAMIENTO DE PLÁSTICO
GRUESO EN TODOS LOS LADOS /
THICK POLY BATTING INSULATION
ON ALL SIDES /
REMBOURRAGE POLYESTER ISOLANT
ÉPAIS SUR TOUS LES CÔTÉS /
DICKER MEHRSCHLAGSCHUTZ AUF
ALLEN SEITEN

VENTANA GRANDE DE PVC PARA EXHIBIR
LA MARCA Y ALBERGAR LISTAS DE PEDIDOS,
MENÚS O FOLLETOS /

LARGE PVC WINDOW FOR BRANDING, HOUSING
ORDER SLIPS, MENUS, OR BROCHURES /

GRANDE FENÊTRE EN PVC POUR LA STRATÉGIE
DE MARQUE OU INSÉRER BONS DE COMMANDE,
MENUS OU BROCHURES /

GROSSES PVC-SICHTFENSTER ZUM
SICHTBARMACHEN DER MARKE UND
VERSTAUEN VON BESTELLISTEN, MENÜS
ODER BROSCHÜREN

FORRO DE LÁMINA DE ALUMINIO
(8 mm) QUE AÍSLA Y DIRECCIONA LAS
TEMPERATURAS ALTAS Y BAJAS /

FOIL LINER (8 mm) INSULATING AND
DIRECTING HOT AND COLD TEMPS /

REVÊTEMENT INTÉRIEUR EN ALUMINIUM
(8 mm) ISOLANT LES ALIMENTS CHAUDS
ET FROIDS /

ALUMINIUMSCHICHT-FUTTER (8 mm),
DAS ISOLIERT UND HOHE UND NIEDRIGE
TEMPERATUREN LEITET /

RIBETES REFLECTANTES PARA UN
REPARTO NOCTURNO MÁS SEGURO /

REFLECTIVE PIPING FOR SAFER
NIGHT TIME DELIVERY /

PASSEPOIL RÉFLÉCHISSANT POUR DES
LIVRAISONS PLUS SÛRES LA NUIT /

REFLEKTORSTREIFEN FÜR SICHERE
LIEFERUNG IM DUNKELN

SOLAPA DE CIERRE Y SOLAPAS DE TAPA
CON CREMALLERA PARA BRINDAR
AISLAMIENTO ADICIONAL /

CLOSING FLAP AND ZIPPED LID FLAPS
FOR EXTRA INSULATION /

RABAT DE FERMETURE ET RABATS DE
COUVERCLE ZIPPÉS POUR UNE ISOLATION
RENFORCÉE /

VERSCHLUSSKLAPPE UND
DECKELKLAPPEN MIT REISSVERSCHLUSS
FÜR EXTRASCHUTZ

VPB Bolsas para pizza / Pizza Bags / Sacs à pizzas / Pizzataschen

	REF	SERIE	cm	
Bolsa para pizza, 16" / 16" Pizza bag / Sac à pizzas, 16" / Pizzataschen 16"	VPB316	SERIE 3	44,5 x 44,5 x 22,9	1
	VPB51602	SERIE 5	44,5 x 44,5 x 22,9	1
Bolsa para pizza, 18" / 18" Pizza bag / Sac à pizzas, 18" / Pizzataschen 18"	VPB318	SERIE 3	48,3 x 48,3 x 22,9	1
	VPB51802	SERIE 5	48,3 x 48,3 x 22,9	1
	VPB5P1802	SERIE 5P	48,3 x 48,3 x 22,9	1



VDB Bolsas de catering / Catering bags / Sacs de traiteur / Cateringtaschen

VDBM

Bolsa de catering mediana con forro de vinilo /
Medium catering bag with vinyl liner /
Sac de traiteur moyen avec revêtement intérieur en vinyle /
Mittelgroße Cateringtasche mit Vinylfutter

	REF	SERIE	cm	
Bolsa de catering mediana con forro extraíble y 2 separadores de fuentes / Medium catering bag with removable liner and 2 pan separators / Sac de traiteur moyen avec revêtement intérieur amovible et 2 séparations de bac / Mittelgroße Cateringtasche mit abnehmbarem Futter und 2 Behälter-Trennwänden	VDBM300	SERIE 3	43,2 x 33 x 22,9	1
	VCBM300	SERIE 3	43,2 x 33 x 22,9	1
Bolsa de catering grande con forro extraíble y 3 separadores de fuentes / Large catering bag with removable liner and 3 pan separators / Grand sac de traiteur avec revêtement intérieur amovible et 3 séparations de bac / Große Cateringtasche mit abnehmbarem Futter und 3 Behälter-Trennwänden	VCBM50002	SERIE 5	43,2 x 33 x 22,9	1
	VCBL300	SERIE 3	58,4 x 38,1 x 35,6	1
	VCBL50002	SERIE 5	58,4 x 38,1 x 35,6	1
	VCBL5P0002	SERIE 5P	58,4 x 38,1 x 35,6	1

VCBM

Bolsa de catering mediana con forro extraíble y 2 separadores de fuentes /
Medium catering bag with removable liner and 2 pan separators /
Sac de traiteur moyen avec revêtement intérieur amovible et 2 séparations de bac /
Mittelgroße Cateringtasche mit abnehmbarem Futter und 2 Behälter-Trennwänden

VCBL

Bolsa de catering grande con forro extraíble y 3 separadores de fuentes /
Large catering bag with removable liner and 3 pan separators /
Grand sac de traiteur avec revêtement intérieur amovible et 3 séparations de bac /
Große Cateringtasche mit abnehmbarem Futter und 3 Behälter-Trennwänden



**ACCESORIOS / ACCESSORIES /
ACCESSOIRES / ZUBEHÖR**

VMCOMP12

Divisor 12 compartimentos /
Divider 12 compartments /
Séparateur 12 compartiments /
Teiler 12 Fächer

VTB Bolsas torre / Tower bags / Sacs-Tours / Hohe Taschen

Bolsa tipo torre con asas de mochila y correa de reposacabezas /
Tower bag with backpack straps and headrest strap /
Sac-tour avec bretelles de sac à dos et sangle d'appui-tête /
Hohe Tasche mit Rucksackgurten und Kopfstützengurt

REF	SERIE	cm	
VTB300	SERIE 3	45,7 x 55,9 x 43,2	1
VTB50002	SERIE 5	45,7 x 55,9 x 43,2	1
VTB5P0002	SERIE 5P	45,7 x 55,9 x 43,2	1



ACCESORIOS / ACCESSORIES /
ACCESSOIRES / ZUBEHÖR

VTBWR-1
Estructura metálica /
Wire insert /
Structure métallique /
Metallstruktur

VDBBM Mochila reparto de alimentos / Food delivery backpack bags /
Sacs à dos de livraison d'aliments / Lebensmittel-Lieferrucksack

Bolsa mochila con bastidor integrado para reparto de alimentos /
Food delivery backpack bag with integrated frame /
Sac à dos de livraison d'aliments à armature intégrée /
Rucksack mit integriertem Gestell für Lebensmittel-Auslieferung

REF	SERIE	cm	
VDBBM300	SERIE 3	40,6 x 40,6 x 33	1
VDBBM50002	SERIE 5	40,6 x 40,6 x 33	1
VDBBM5P0002	SERIE 5P	40,6 x 40,6 x 33	1



RECAMBIOS / SPARE PARTS / PIÈCES DE RECHANGE / ERSATZTEILE



P142.000

ASADOR GRILL MANGO MADERA / GRILL WOODEN HANDLE /
GRILL QUEUE EN BOIS / PFANNENHOLZGRIFF

REF	DESCRIPCIÓN	DESCRIPTION	DESCRIPTION	BESCHREIBUNG
RE142000	MANGO MADERA	WOODEN HANDLE	QUEUE EN BOIS	HOLZGRIFF



P15.000

FREIDORA / FRYER /
FRITEUSE / FRITEUSSE

REF	DESCRIPCIÓN	DESCRIPTION	DESCRIPTION	BESCHREIBUNG
RE15000	CESTA MALLA	MESH BASKET	PANIER À MAILLES	MASCHENKORB
RE150001	RESISTENCIA	ELEMENT	RÉSISTANCE	HEIZELEMENT
RE1500010	CABEZAL	COMPLETE HEAD	TÊTE COMPLÈTE	KOMPLETTER KOPF
RE1500011	TAPÓN + ARANDELA CABLE	CAP + WASHER FOR	EMBOUT + RONDELLE DE	STÖPSEL + DICHTUNGSRING FÜR
	TERMOSTATO	THERMOSTAT CABLE	CABLE DE THERMOSTAT	THERMOSTATKABEL
RE150003	TERMOSTATO	THERMOSTAT	THERMOSTAT	THERMOSTAT
RE150004	TERMOSTATO DE SEGURIDAD	SECURITY THERMOSTAT	THERMOSTAT DE SÉCURITÉ	SICHERHEITSTHERMOSTAT
RE150005	MANDO TERMOSTATO	THERMOSTAT KNOB	COMMANDE THERMOSTAT	THERMOSTATREGLER
RE150006	INTERRUPTOR DE CONTACTO	CONTACT SWITCH	INTERRUPTEUR DE CONTACT	KONTAKTSCHALTER
RE150009	LUZ PILOTO VERDE	POWER INDICATOR GREEN	VOYANT VERT	GRÜNE KONTROLLLEUCHE
RE1500091	LUZ PILOTO NARANJA	POWER INDICATOR ORANGE	VOYANT ORANGE	ORANGE KONTROLLLEUCHE
RE150025	CABLE POTENCIA	POWER CORD	CABLE DE PUISSANCE	STROMKABEL
RE150026	PIE	FOOT	PIED	FUSS
RE150703	ASA LATERAL BAQUELITA	BAKELITE SIDE HANDLE	ANSE LATÉRALE EN BAKÉLITE	SEITLICH BAKELITGRIFF



P15.001

FREIDORA / FRYER /
FRITEUSE / FRITEUSSE

REF	DESCRIPCIÓN	DESCRIPTION	DESCRIPTION	BESCHREIBUNG
RE15000	CESTA MALLA	MESH BASKET	PANIER À MAILLES	MASCHENKORB
RE150001	RESISTENCIA	ELEMENT	RÉSISTANCE	HEIZELEMENT
RE1500010	CABEZAL	COMPLETE HEAD	TÊTE COMPLÈTE	KOMPLETTER KOPF
RE1500011	TAPÓN + ARANDELA CABLE	CAP + WASHER FOR	EMBOUT + RONDELLE DE	STÖPSEL + DICHTUNGSRING FÜR
	TERMOSTATO	THERMOSTAT CABLE	CABLE DE THERMOSTAT	THERMOSTATKABEL
RE150003	TERMOSTATO	THERMOSTAT	THERMOSTAT	THERMOSTAT
RE150004	TERMOSTATO DE SEGURIDAD	SECURITY THERMOSTAT	THERMOSTAT DE SÉCURITÉ	SICHERHEITSTHERMOSTAT
RE150005	MANDO TERMOSTATO	THERMOSTAT KNOB	COMMANDE THERMOSTAT	THERMOSTATREGLER
RE150006	INTERRUPTOR DE CONTACTO	CONTACT SWITCH	INTERRUPTEUR DE CONTACT	KONTAKTSCHALTER
RE150009	LUZ PILOTO VERDE	POWER INDICATOR GREEN	VOYANT VERT	GRÜNE KONTROLLLEUCHE
RE1500091	LUZ PILOTO NARANJA	POWER INDICATOR ORANGE	VOYANT ORANGE	ORANGE KONTROLLLEUCHE
RE150025	CABLE POTENCIA	POWER CORD	CABLE DE PUISSANCE	STROMKABEL
RE150026	PIE	FOOT	PIED	FUSS
RE150703	ASA LATERAL BAQUELITA	BAKELITE SIDE HANDLE	ANSE LATÉRALE EN BAKÉLITE	SEITLICH BAKELITGRIFF



P15.002

FREIDORA / FRYER /
FRITEUSE / FRITEUSSE

REF	DESCRIPCIÓN	DESCRIPTION	DESCRIPTION	BESCHREIBUNG
RE15000	CESTA MALLA	MESH BASKET	PANIER À MAILLES	MASCHENKORB
RE150001	RESISTENCIA	ELEMENT	RÉSISTANCE	HEIZELEMENT
RE1500011	TAPÓN + ARANDELA CABLE	CAP + WASHER FOR +	EMBOUT + RONDELLE DE CABLE	STÖPSEL + DICHTUNGSRING FÜR
	TERMOSTATO	THERMOSTAT CABLE	DE THERMOSTAT	THERMOSTATKABEL
RE150003	TERMOSTATO	THERMOSTAT	THERMOSTAT	THERMOSTAT
RE150004	TERMOSTATO DE SEGURIDAD	SECURITY THERMOSTAT	THERMOSTAT DE SÉCURITÉ	SICHERHEITSTHERMOSTAT
RE150005	MANDO TERMOSTATO	THERMOSTAT KNOB	COMMANDE THERMOSTAT	THERMOSTATREGLER
RE150006	INTERRUPTOR DE CONTACTO	CONTACT SWITCH	INTERRUPTEUR DE CONTACT	KONTAKTSCHALTER
RE150007	CABEZAL	COMPLETE HEAD	TÊTE COMPLÈTE	KOMPLETTER KOPF
RE150008	INTERRUPTOR	ON/OFF SWITCH	INTERRUPTEUR	AN/ AUSSCHALTER
RE150009	ENCENDIDO/APAGADO		ALLUMAGE/EXTINCTION	AN/ AUSSCHALTER
	LUZ PILOTO VERDE	POWER INDICATOR GREEN	VOYANT VERT	GRÜNE KONTROLLLEUCHE
RE1500091	LUZ PILOTO NARANJA	POWER INDICATOR ORANGE	VOYANT ORANGE	ORANGE KONTROLLLEUCHE
RE150022	GRIFO VACIADO	DRAINAGE TAP	ROBINET VIDANGE	ABLAUFHAHN
RE150023	SOPORTE RESISTENCIA	RESISTANCE SUPPORT	SUPPORT DE RÉSTANCE	HALTERUNG FÜR HEIZELEMENT
RE150024	JUNTA PROTECTORA	RESISTANCE PROTECTOR	ENSEMBLE PROTECTEUR DE	SCHUTZDICHTUNGSRING FÜR
	RESISTENCIA	SEAL	RÉSISTANCE	HEIZELEMENT
RE150025	CABLE POTENCIA	POWER CORD	CABLE DE PUISSANCE	STROMKABEL
RE150026	PIE	FOOT	PIED	FUSS



P15.003

FREIDORA / FRYER /
FRITEUSE / FRITTEUSE

REF	DESCRIPCIÓN	DESCRIPTION	DESCRIPTION	BESCHREIBUNG
RE15000	CESTA MALLA	MESH BASKET	PANIER À MAILLES	MASCHENKORB
RE150001	RESISTENCIA	ELEMENT	RÉSISTANCE	HEIZELEMENT
RE1500011	TAPÓN + ARANDELA CABLE	CAP + WASHER FOR	EMBOUT + RONDELLE DE	STÖPSEL + DICHTUNGSRING
	TERMOSTATO	THERMOSTAT CABLE	CABLE DE THERMOSTAT	FÜR THERMOSTATKABEL
RE150003	TERMOSTATO	THERMOSTAT	THERMOSTAT	THERMOSTAT
RE150004	TERMOSTATO DE SEGURIDAD	SECURITY THERMOSTAT	THERMOSTAT DE SÉCURITÉ	SICHERHEITSTHERMOSTAT
RE150005	MANDO THERMOSTATO	THERMOSTAT KNOB	COMMANDE THERMOSTAT	THERMOSTATREGLER
RE150006	INTERRUPTOR DE CONTACTO	CONTACT SWITCH	INTERRUPTEUR DE CONTACT	KONTAKTSCHALTER
RE150007	CABEZAL	COMPLETE HEAD	TÊTE COMPLÈTE	KOMPLETTER KOPF
RE150008	INTERRUPTOR	ON/OFF SWITCH	INTERRUPTEUR	AN/ AUSSCHALTER
	ENCENDIDO/APAGADO		ALLUMAGE/EXTINCTION	
RE150009	LUZ PILOTO VERDE	POWER INDICATOR GREEN	VOYANT VERT	GRÜNE KONTROLLLEUCHE
RE1500091	LUZ PILOTO NARANJA	POWER INDICATOR ORANGE	VOYANT ORANGE	ORANGE KONTROLLLEUCHE
RE150022	GRIFO VACIADO	DRAINAGE TAP	ROBINET VIDANGE	ABLAUFHAHN
RE150025	CABLE POTENCIA	POWER CORD	CABLE DE PUISSANCE	STROMKABEL
RE150026	PIE	FOOT	PIED	FUSS



P15.004

GRILL DE CONTACTO / CONTACT GRILL /
GRILL DE CONTACT / KONTAKTGRILL

REF	DESCRIPCIÓN	DESCRIPTION	DESCRIPTION	BESCHREIBUNG
RE150041	INTERRUPTOR	SWITCH	INTERRUPTEUR	SCHALTER
RE150042	TERMOSTATO	THERMOSTAT	THERMOSTAT	THERMOSTAT
RE150043	TERMOSTATO SEGURIDAD	SECURITY THERMOSTAT	THERMOSTAT SÉCURITÉ	SICHERHEITSTHERMOSTAT
RE150044	MUELLES	SPRING	RESSORTS	FEDERN
RE150045	RESISTENCIA SUPERIOR	UPPER ELEMENT	RÉSISTANCE SUPÉRIEURE	OBERES HEIZELEMENT
RE150046	RESISTENCIA INFERIOR	LOWER ELEMENT	RÉSISTANCE INFÉRIEURE	UNTERES HEIZELEMENT
RE150047	MANGO INOX	ST/STEEL HANDLE	MANCHE INOX	GRIFF ROSTFREIER STAHL
RE150048	SILICONA	SILICONE	SILICONE	SILIKON
RE150049	MANGO INOX + SILICONA	ST/STEEL HANDLE + SILICONE	MANCHE INOX + SILICONE	GRIFF ROSTFREIER STAHL + SILIKON



P15.005

GRILL DE CONTACTO / CONTACT GRILL /
GRILL DE CONTACT / KONTAKTGRILL

REF	DESCRIPCIÓN	DESCRIPTION	DESCRIPTION	BESCHREIBUNG
RE1500092	FIJACIÓN SOPORTE ASA	FIXING SUPPORT FOR HANDLE	FIXATION DE SUPPORT	GRIFFHALTERUNG
		SWITCH	POUR ANSE	
RE150041	INTERRUPTOR	THERMOSTAT	INTERRUPTEUR	SCHALTER
RE150042	TERMOSTATO	SECURITY THERMOSTAT	THERMOSTAT	THERMOSTAT
RE150043	TERMOSTATO SEGURIDAD	SPRING	THERMOSTAT SÉCURITÉ	SICHERHEITSTHERMOSTAT
RE150044	MUELLES	UPPER ELEMENT	RESSORTS	FEDERN
RE150051	RESISTENCIA SUPERIOR	LOWER ELEMENT	RÉSISTANCE SUPÉRIEURE	OBERES HEIZELEMENT
RE150052	RESISTENCIA INFERIOR	REAR AXLE	RÉSISTANCE INFÉRIEURE	UNTERES HEIZELEMENT
RE150053	EJE POSTERIOR	HANDLE	AXE POSTÉRIEUR	OBERE ACHSE
RE150054	MANGO	SILICONE	MANCHE	GRIFF
RE150055	SILICONA	ST/STEEL HANDLE + SILICONE	SILICONE	SILIKON
RE150056	MANGO INOX + SILICONA		MANCHE INOX + SILICONE	GRIFF ROSTFREIER STAHL + SILIKON

P15.006

GRILL DE CONTACTO / CONTACT GRILL /
GRILL DE CONTACT / KONTAKTGRILL

REF	DESCRIPCIÓN	DESCRIPTION	DESCRIPTION	BESCHREIBUNG
RE1500092	FIJACIÓN SOPORTE ASA	FIXING SUPPORT FOR HANDLE	FIXATION DE SUPPORT	GRIFFHALTERUNG
			POUR ANSE	
RE150041	INTERRUPTOR	SWITCH	INTERRUPTEUR	SCHALTER
RE150042	TERMOSTATO	THERMOSTAT	THERMOSTAT	THERMOSTAT
RE150043	TERMOSTATO SEGURIDAD	SECURITY THERMOSTAT	THERMOSTAT SÉCURITÉ	SICHERHEITSTHERMOSTAT
RE150044	MUELLES	SPRING	RESSORTS	FEDERN
RE150051	RESISTENCIA SUPERIOR	UPPER ELEMENT	RÉSISTANCE SUPÉRIEURE	OBERES HEIZELEMENT
RE150052	RESISTENCIA INFERIOR	LOWER ELEMENT	RÉSISTANCE INFÉRIEURE	UNTERES HEIZELEMENT
RE150053	EJE POSTERIOR	REAR AXLE	AXE POSTÉRIEUR	OBERE ACHSE
RE150054	MANGO	HANDLE	MANCHE	GRIFF
RE150055	SILICONA	SILICONE	SILICONE	SILIKON
RE150056	MANGO INOX + SILICONA	ST/STEEL HANDLE + SILICONE	MANCHE INOX + SILICONE	GRIFF ROSTFREIER STAHL + SILIKON
RE150061	PLANCHA LISA INFERIOR	LOWER SMOOTH PLATE	PLANCHE LISSE INFÉRIEURE	+ SILIKON



P15.007

GRILL DE CONTACTO / CONTACT GRILL /
GRILL DE CONTACT / KONTAKTGRILL

REF	DESCRIPCIÓN	DESCRIPTION	DESCRIPTION	BESCHREIBUNG
RE150041	INTERRUPTOR	SWITCH	INTERRUPTEUR	SCHALTER
RE150042	TERMOSTATO	THERMOSTAT	THERMOSTAT	THERMOSTAT
RE150043	TERMOSTATO SEGURIDAD	SECURITY THERMOSTAT	THERMOSTAT SÉCURITÉ	SICHERHEITSTHERMOSTAT
RE150044	MUELLES	SPRING	RESSORTS	FEDERN

P15.008

GRILL DE CONTACTO / CONTACT GRILL /
GRILL DE CONTACT / KONTAKTGRILL

REF	DESCRIPCIÓN	DESCRIPTION	DESCRIPTION	BESCHREIBUNG
RE150041	INTERRUPTOR	SWITCH	INTERRUPTEUR	SCHALTER
RE150042	TERMOSTATO	THERMOSTAT	THERMOSTAT	THERMOSTAT
RE150043	TERMOSTATO SEGURIDAD	SECURITY THERMOSTAT	THERMOSTAT SÉCURITÉ	SICHERHEITSTHERMOSTAT
RE150044	MUELLES	SPRING	RESSORTS	FEDERN



P15.009

GRILL DE CONTACTO / CONTACT GRILL /
GRILL DE CONTACT / KONTAKTGRILL

REF	DESCRIPCIÓN	DESCRIPTION	DESCRIPTION	BESCHREIBUNG
RE1500092	FIJACIÓN SOPORTE ASA	FIXING SUPPORT FOR HANDLE	FIXATION DE SUPPORT POUR ANSE	GRIFFHALTERUNG
RE150041	INTERRUPTOR	SWITCH	INTERRUPTEUR	SCHALTER
RE150042	TERMOSTATO	THERMOSTAT	THERMOSTAT	THERMOSTAT
RE150043	TERMOSTATO SEGURIDAD	SECURITY THERMOSTAT	THERMOSTAT SÉCURITÉ	SICHERHEITSTHERMOSTAT
RE150044	MUELLES	SPRING	RESSORTS	FEDERN



P15.010

BAÑO MARIA MÁX. 40 °C / CHOCOLATE WARMER MAX. 40 °C /
CHAUFFE-CHOCOLAT MAX. 40 °C / WASSERBAD MAX. 40 °C

REF	DESCRIPCIÓN	DESCRIPTION	DESCRIPTION	BESCHREIBUNG
RE150101	TERMOSTATO	THERMOSTAT	THERMOSTAT	THERMOSTAT
RE150102	RESISTENCIA	ELEMENT	RÉSISTANCE	HEIZELEMENT



P15.026

CALENTADOR DE PLATOS CAPACIDAD 30 U / HOT CUPBOARD CAPACITY 30 U /
CHAUFFE-ASSIETTES CAPACITÉ 30 U / TELLERWÄRMER FASSUNGSVERMÖGEN 30 STÜCK

REF	DESCRIPCIÓN	DESCRIPTION	DESCRIPTION	BESCHREIBUNG
RE150260	SOPORTE PIE	SUPPORT FOOT	SUPPORT PIED	FUSSHALTER
RE150261	ESTANTE	SHELF	ÉTAGÈRE	REGAL
RE150262	RESISTENCIA	ELEMENT	RÉSISTANCE	HEIZELEMENT
RE150263	SOPORTE	SUPPORT	SUPPORT	HALTER



P15.027

CALENTADOR DE PLATOS CAPACIDAD 60 U / HOT CUPBOARD CAPACITY 60 U /
CHAUFFE-ASSIETTES CAPACITÉ 60 U / TELLERWÄRMER FASSUNGSVERMÖGEN 60 STÜCK

REF	DESCRIPCIÓN	DESCRIPTION	DESCRIPTION	BESCHREIBUNG
RE150271	ESTANTE	SHELF	ÉTAGÈRE	REGAL
RE150272	RESISTENCIA	ELEMENT	RÉSISTANCE	HEIZELEMENT



P15028

CALENTADOR DE PLATOS CAPACIDAD 120 U / HOT CUPBOARD CAPACITY 120 U /
CHAUFFE-ASSIETTES CAPACITÉ 120 U / TELLERWÄRMER FASSUNGSVERMÖGEN 120 STÜCK

REF	DESCRIPCIÓN	DESCRIPTION	DESCRIPTION	BESCHREIBUNG
RE150281	ESTANTE	SHELF	ÉTAGÈRE	REGAL
RE150282	RESISTENCIA	ELEMENT	RÉSISTANCE	HEIZELEMENT

P15.035



HORNO MULTIFUNCIONAL DE CONVECCIÓN / CONVECTION OVEN /
FOUR À AIR PULSE / KONFEKTIONSOFFEN

REF	DESCRIPCIÓN	DESCRIPTION	DESCRIPTION	BESCHREIBUNG
RE15035	REJILLA	GRID	GRILLE	GRILLROST
RE150352	BANDEJA	TRAY	PLATEAU	TABLETT
RE150353	GOMA	RUBBER	CAOUTCHOUC	GUMMI
RE150354	TERMOSTATO	THERMOSTAT	THERMOSTAT	THERMOSTAT
RE150355	TERMOSTATO SEGURIDAD	SECURITY THERMOSTAT	THERMOSTAT SÉCURITÉ	SICHERHEITSTHERMOSTAT
RE150356	BISAGRA	HINGE	CHARNIÈRE	SCHANIER
RE150357	RESISTENCIA	ELEMENT	RÉSISTANCE	HEIZELEMENT
RE150358	VENTILADOR - MOTOR	FAN - MOTOR	VENTILATEUR - MOTEUR	VENTILATIONSMOTOR
RE150359	TEMPORIZADOR	TIMER	TEMPORISATEUR	TIMER
RE1503510	MANDO TEMPORIZADOR	TIMER KNOB	COMMANDE TEMPORISATEUR	TIMERKNOPF
RE1503511	CRISTAL EXTERIOR	GLASS EXTERIOR	VITRE EXTÉRIEURE	AUSSENGLAS
RE1503512	TIRADOR	HANDLE	POIGNÉE	GRIFF
RE1503513	CRISTAL INTERIOR	GLASS INTERIOR	VITRE INTÉRIEURE	INNENGLAS
RE1503514	SOPORTE INFERIOR CRISTAL	GLASS BOTTOM SUPPORT	SUPPORT INFÉRIEUR EN VERRE	HALTER FÜR INNENGLAS
RE1503515	SOPORTE FIJO BISAGRA PARA PUERTA	FIXED SUPPORT WITH HINGE FOR DOOR	SUPPORT FIXE AVEC CHARNIÈRE POUR PORTE	FESTER SCHANIERHALTER FÜR DIE TÜR
RE1503516	SOPORTE TIRADOR PUERTA	DOOR HANDLE SUPPORT	SUPPORT AVEC POIGNÉE DE PORTE	TÜRGRIFHALTER
RE1503517	BOMBILLA	LIGHT BULB	AMPOULLE	LAMPE
RE1503518	PROTECTOR BOMBILLA	LIGHT BULB PROTECTOR	PROTECTION D'AMPOULLE	LAMPENSCHUTZ

P15.036



SALAMANDRA CON PARTE SUPERIOR REGULABLE / SALAMANDER WITH ADJUSTABLE TOP /
SALAMANDRE AVEC REGULATION DU PLAFOND / SALAMANDER MIT BEWEGLICHEM OBERTEIL

REF	DESCRIPCIÓN	DESCRIPTION	DESCRIPTION	BESCHREIBUNG
RE150361	RESISTENCIA	ELEMENT	RÉSISTANCE	HEIZELEMENT
RE150362	BANDEJA GOTEÓ	DRIP PLATE	PLATEAU ÉGOUTTAGE	TROPFGITTER
RE150363	TERMOSTATO	THERMOSTAT	THERMOSTAT	THERMOSTAT

P15.038



TOSTADORA PARA SANDWICH CON 3 Y 6 PINZAS / SANDWICH TOASTER WITH 3 & 6 TONGS /
TOASTEUR À SANDWICH AVEC 3 ET 6 PINCES / SANDWICHTOASTER MIT 3 UND 6 ZANGEN

REF	DESCRIPCIÓN	DESCRIPTION	DESCRIPTION	BESCHREIBUNG
RE150381	RESISTENCIA	ELEMENT	RÉSISTANCE	HEIZELEMENT
RE150382	TERMOSTATO	THERMOSTAT	THERMOSTAT	THERMOSTAT
RE150383	MANDO TEMPORIZADOR	TIMER KNOB	COMMANDE TEMPORISATEUR	TIMERKNOPF
RE150384	MANDO TERMOSTATO	THERMOSTAT KNOB	COMMANDE THERMOSTAT	THERMOSTATREGLER
RE150385	TEMPORIZADOR	TIMER	TEMPORISATEUR	TIMER
RE150386	REGLETA CERÁMICA	CERAMICAL TERMINAL	RÈGLETTE EN CÉRAMIQUE	KERAMISCHE SCHINE
RE150387	PRENSA ESTOPAS	CABLE GLAND	PRESSE-ÉTOUPES	PRESSE- TUCH
RE150388	AISLAMIENTO CERÁMICO	CERAMIC INSULATOR	ISOLANT EN CÉRAMIQUE	KERAMISCHE ISOLIERUNG
RE15039	PINZA SANDWICH	SANDWICH TONG	PINCE À SANDWICH	SANDWICHZANGE
RE150391	REGLETA	TERMINAL	RÈGLETTE	SCHIENE

P15.039



TOSTADORA PARA SANDWICH CON 3 Y 6 PINZAS / SANDWICH TOASTER WITH 3 & 6 TONGS /
TOASTEUR À SANDWICH AVEC 3 ET 6 PINCES / SANDWICHTOASTER MIT 3 UND 6 ZANGEN

REF	DESCRIPCIÓN	DESCRIPTION	DESCRIPTION	BESCHREIBUNG
RE150382	TERMOSTATO	THERMOSTAT	THERMOSTAT	THERMOSTAT
RE150383	MANDO TEMPORIZADOR	TIMER KNOB	COMMANDE TEMPORISATEUR	TIMERKNOPF
RE150384	MANDO TERMOSTATO	THERMOSTAT KNOB	COMMANDE THERMOSTAT	THERMOSTATREGLER
RE150385	TEMPORIZADOR	TIMER	TEMPORISATEUR	TIMER
RE150386	REGLETA CERÁMICA	CERAMICAL TERMINAL	RÈGLETTE EN CÉRAMIQUE	KERAMISCHE SCHIENE
RE150387	PRENSA ESTOPAS	CABLE GLAND	PRESSE-ÉTOUPES	PRESSE- TUCH
RE150388	AISLAMIENTO CERÁMICO	CERAMIC INSULATOR	ISOLANT EN CÉRAMIQUE	KERAMISCHE ISOLIERUNG
RE15039	PINZA SANDWICH	SANDWICH TONG	PINCE À SANDWICH	SANDWICHZANGE
RE150391	REGLETA	TERMINAL	RÈGLETTE	SCHIENE
RE1503919A	RESISTENCIA	ELEMENT	RÉSISTANCE	HEIZELEMENT

P15.040



TOSTADORA / TOASTER /
TOASTEUR / TOASTER

REF	DESCRIPCIÓN	DESCRIPTION	DESCRIPTION	BESCHREIBUNG
RE150400	PIÉS	FEET	PIEDS	FÜSSE
RE150401	RESISTENCIA 500W	500W ELEMENT	RÉSISTANCE 500W	HEIZELEMENT 500W
RE150402	RESISTENCIA 370W	370W ELEMENT	RÉSISTANCE 370W	HEIZELEMENT 370W
RE150403	TEMPORIZADOR	TIMER	TEMPORISATEUR	TIMER
RE150404	INTERRUPTOR	SWITCH	INTERRUPTEUR	SCHALTER
RE150405	MANDO TEMPORIZADOR	TIMER KNOB	COMMANDE TEMPORISATEUR	TIMERKNOPF



P15.041

TOSTADORA / TOASTER /
TOASTEUR / TOASTER

REF	DESCRIPCIÓN	DESCRIPTION	DESCRIPTION	BESCHREIBUNG
RE150400	PIÉS	FEET	PIEDS	FÜSSE
RE150403	TEMPORIZADOR	TIMER	TEMPORISATEUR	TIMER
RE150404	INTERRUPTOR	SWITCH	INTERRUPTEUR	SCHALTER
RE150405	MANDO TEMPORIZADOR	TIMER KNOB	COMMANDE TEMPORISATEUR	TIMERKNOPF
RE150411	RESISTENCIA 500W	500W ELEMENT	RÉSISTANCE 500W	HEIZELEMENT 500W
RE150412	RESISTENCIA 370W	370W ELEMENT	RÉSISTANCE 370W	HEIZELEMENT 370W



P15.042

TOSTADORA CONTINUA / CONVEYOR TOASTER /
TOASTEUR CONVEYEUR / DURCHLAUFTOASTER

REF	DESCRIPCIÓN	DESCRIPTION	DESCRIPTION	BESCHREIBUNG
RE150421	RESISTENCIA SUPERIOR	UPPER ELEMENT	RÉSISTANCE SUPERIOR	OBERES HEIZELEMENT
RE150422	RESISTENCIA INFERIOR	LOWER ELEMENT	RÉSISTANCE INFÉRIEURE	UNTERES HEIZELEMENT
RE150423	MOTOR	MOTOR	MOTEUR	MOTOR
RE150424	VENTILADOR	FAN	VENTILATEUR	VENTILATOR
RE150425	SELECTION SWITCH	SELECTION SWITCH	SÉLECTION INTERRUPTEUR	AUSWAHLSCHALTER
RE150426	REGULADOR VELOCIDAD	ADJUSTABLE SPEED	RÉGULATEUR VITESSE	GESCHWINDIGKEITSREGLER
RE150427	POTENCIOMETRO	POTENTIOMETER	POTENCIOMÈTRE	POTENZREGLER
RE150428	POMO	KNOB	POMMEAU	KNOPF



P15.044

MÁQUINA DE COCER PASTA / PASTA COOKER /
CUISEUR À PÂTE / NUDELKOCHER

REF	DESCRIPCIÓN	DESCRIPTION	DESCRIPTION	BESCHREIBUNG
RE150441	CESTA MALLA GRANDE CON ASAS	BIG MESH BASKET WITH HANDLES	PANIER GRANDE MAILLE À ANSES	GROSSER MASCHENKORB MIT GRIFFEN
RE150442	CESTA MALLA PEQUEÑA CON MANGO	SMALL MESH BASKET WITH HANDLE	PANIER PETITE MAILLE À MANCHE	KLEINER MASCHENKORB MIT GRIFFEN
RE150443	TERMOSTATO	THERMOSTAT	THERMOSTAT	THERMOSTAT
RE150444	GRIFO DESAGUE	DRAINAGE TAP	ROBINET ÉCOULEMENT	ABLAUFHAHN
RE150445	CONEXIÓN BM GRIFO DRENAJE	BM CONNECTION DRAINING TAP	CONNECTION BM ROBINET DE DRAINAGE	BM VERBINDUNG ABLAUFHAHN



P15.070

FREIDORA / FRYER /
FRITEUSE / FRITEUSSE

REF	DESCRIPCIÓN	DESCRIPTION	DESCRIPTION	BESCHREIBUNG
RE1500011	TAPÓN + ARANDELA CABLE	CAP + WASHER FOR THERMOSTAT CABLE	EMBOUT + RONDELLE DE CABLE DE THERMOSTAT	STÖPSEL + DICHTUNGSRING FÜR THERMOSTATKABEL
RE150003	TERMOSTATO	THERMOSTAT	THERMOSTAT	THERMOSTAT
RE150004	TERMOSTATO DE SEGURIDAD	SECURITY THERMOSTAT	THERMOSTAT DE SÉCURITÉ	SICHERHEITSTHERMOSTAT
RE150005	MANDO TERMOSTATO	THERMOSTAT KNOB	COMMANDE THERMOSTAT	THERMOSTATREGLER
RE150006	INTERRUPTOR DE CONTACTO	CONTACT SWITCH	INTERRUPTEUR DE CONTACT	KONTAKTSCHALTER
RE150009	LUZ PILOTO VERDE	POWER INDICATOR GREEN	VOYANT VERT	GRÜNE KONTROLLLEUCHE
RE1500091	LUZ PILOTO NARANJA	POWER INDICATOR ORANGE	VOYANT ORANGE	ORANGE KONTROLLLEUCHE
RE150025	CABLE POTENCIA	POWER CORD	CABLE DE PUISSANCE	STROMKABEL
RE150026	PIE	FOOT	PIED	FUSS
RE15070	CESTA MALLA	MESH BASKET	PANIER MAILLE	MASCHENKORB
RE150701	RESISTENCIA	ELEMENT	RÉSISTANCE	HEIZELEMENT
RE150702	CABEZAL PARA	HEAD	TÊTE	KOPF
RE150703	ASA LATERAL BAQUELITA	BAKELITE SIDE HANDLE	ANSE LATÉRALE EN BAKÉLITE	SEITLICHR BAKELITGRIF



P15.071

FREIDORA / FRYER /
FRITEUSE / FRITEUSSE

REF	DESCRIPCIÓN	DESCRIPTION	DESCRIPTION	BESCHREIBUNG
RE1500011	TAPÓN + ARANDELA CABLE TERMOSTATO	CAP + WASHER FOR THERMOSTAT CABLE	EMBOUT + RONDELLE DE CABLE DE THERMOSTAT	STÖPSEL + DICHTUNGSRING FÜR THERMOSTATKABEL
RE150003	TERMOSTATO	THERMOSTAT	THERMOSTAT	THERMOSTAT
RE150004	TERMOSTATO DE SEGURIDAD	SECURITY THERMOSTAT	THERMOSTAT DE SÉCURITÉ	SICHERHEITSTHERMOSTAT
RE150005	MANDO TERMOSTATO	THERMOSTAT KNOB	COMMANDE THERMOSTAT	THERMOSTATREGLER
RE150006	INTERRUPTOR DE CONTACTO	CONTACT SWITCH	INTERRUPTEUR DE CONTACT	KONTAKTSCHALTER
RE150009	LUZ PILOTO VERDE	POWER INDICATOR GREEN	VOYANT VERT	GRÜNE KONTROLLLEUCHTE
RE1500091	LUZ PILOTO NARANJA	POWER INDICATOR ORANGE	VOYANT ORANGE	ORANGE KONTROLLLEUCHTE
RE150025	CABLE POTENCIA	POWER CORD	CABLE DE PUISSANCE	STROMKABEL
RE150026	PIE	FOOT	PIED	FUSS
RE15070	CESTA MALLA	MESH BASKET	PANIER MAILLE	MASCHENKORB
RE150701	RESISTENCIA	ELEMENT	RÉSISTANCE	HEIZELEMENT
RE150702	CABEZAL PARA	HEAD	TÊTE	KOPF
RE150703	ASA LATERAL BAQUELITA	BAKELITE SIDE HANDLE	ANSE LATÉRALE EN BAKÉLITE	SEITLICHR BAKELITGRIF

P15.073 / P15.074



PLACA CALIENTE / HEATING PLATE /
PLAQUE CHAUFFANTE / WÄRMEPLATTE

REF	DESCRIPCIÓN	DESCRIPTION	DESCRIPTION	BESCHREIBUNG
RE150740	PIE	BASE	PIED	FUSS



P15.075

CRÊPERA - CRÊPERA DOBLE / CRÊPE MAKER - DOUBLE CRÊPE MAKER /
CRÊPIÈRE - CRÊPIÈRE DOBLE / CRÊPEEISEN

REF	DESCRIPCIÓN	DESCRIPTION	DESCRIPTION	BESCHREIBUNG
RE150751	RESISTENCIA	ELEMENT	RÉSISTANCE	HEIZELEMENT



P15.084 / P15.086

PLANCHA ELÉCTRICA LISA / ELECTRIC GRIDDLE PLAIN /
PLAQUE ÉLECTRIQUE UNIE / GLATTER ELEKTRISCHER GRILL

REF	DESCRIPCIÓN	DESCRIPTION	DESCRIPTION	BESCHREIBUNG
RE150841	RESISTENCIA	ELEMENT	RÉSISTANCE	HEIZELEMENT



P15.097

FUENTE FONDUE CHOCOLATE / CHOCOLATE FOUNTAIN /
FONTAINE À CHOCOLAT / SCHOKOLADENBRUNNEN

REF	DESCRIPCIÓN	DESCRIPTION	DESCRIPTION	BESCHREIBUNG
RE150971	ESPIRAL INTERIOR PLÁSTICO	INTERIOR PLASTIC SPIRALE	SPIRALE INTÉRIEUR EN PLASTIQUE	EINNERE PLASTIKSPIRALE
RE1509741	CARCASA CILÍNDRICA	CYLINDRICAL CARCASE	CARCASSE CYLINDRIQUE	ZYLINDERGEHÄUSE
RE1509744	POMO DE PLÁSTICO	PLASTIC KNOB	POMMEAU EN PLASTIQUE	PLASTIKKNOPF
RE150978	ARANDELA SILICONA	SILICONE WASHER	RONDELLE EN SILICONE	SILIKONDICHTUNG
RE1509799	KIT FUENTE	FOUNTAIN KIT	KIT SOURCE	BRUNNENSET



P19.114-N / P19.114-A / P19.114-R

POSTE CON CINTA RETRÁCTIL ACERO INOX BRILLANTE / BARRIER WITH RETRACTABLE BELT. MIRROR POLISHED /
POTEAU DÉROULEUR À SANGLE. ACIER INOX BRILLANT / SEPERATIONSPFOSTEN MIT EINZIEHBAREM BAND GLÄNZEND

REF	DESCRIPCIÓN	DESCRIPTION	DESCRIPTION	BESCHREIBUNG
RE191110	PIEZA PLÁSTICO	PLASTIC PIECE	PIÈCE EN PLASTIQUE	PLASTIKTEIL
RE191140	BASE	BASE	BASE	BASIS



P248.028 / P248.032 / P248.035 / P248.040 / P248.045

OLLA CON GRIFO Y TAPA / STOCK POT WITH TAP AND LID /
MARMITE TRAITEUR AVEC ROBINET ET COUVERCLE / KOCHTOPF MIT ABLAUFHAHN UND DECKEL

REF	DESCRIPCIÓN	DESCRIPTION	DESCRIPTION	BESCHREIBUNG
IV248000	GRIFO INOX	INOX TAP	ROBINET INOX	GRIFF ROSTFREIER STAHL



P313.025

PASAPURÉS / VEGETABLE SIEVE /
MOULIN À LÉGUMES / PÜRIERSIEB

REF	DESCRIPCIÓN	DESCRIPTION	DESCRIPTION	BESCHREIBUNG
RE3130251	FILTRO FINO	THIN FILTER	FILTRE FIN	FEINER FILTER
RE3130252	FILTRO GRUESO	THICK FILTER	FILTRE EPAIS	GROBER FILTER
RE3130253	POMO	KNOB	POMMEAU	KNOPF
RE3130254	MECANISMO	MECHANISM	MÉCANISME	MECHANISMUS
RE3130255	ASA	HANDLE	ANSE	GRIFF

P313.030

PASAPURÉS / VEGETABLE SIEVE /
MOULIN À LÉGUMES / PÜRIERSIEB

REF	DESCRIPCIÓN	DESCRIPTION	DESCRIPTION	BESCHREIBUNG
RE3130301	FILTRO FINO	THIN FILTER	FILTRE FIN	FEINER FILTER
RE3130302	FILTRO GRUESO	THICK FILTER	FILTRE EPAIS	GROBER FILTER
RE3130303	POMO	KNOB	POMMEAU	KNOPF
RE3130304	MECANISMO	MECHANISM	MÉCANISME	MECHANISMUS



P313.126

PASAPURÉS / VEGETABLE SIEVE /
MOULIN À LÉGUMES / PÜRIERSIEB

REF	DESCRIPCIÓN	DESCRIPTION	DESCRIPTION	BESCHREIBUNG
RE3130261	FILTRO FINO	THIN FILTER	FILTRE FIN	FEINER FILTER
RE3130262	FILTRO GRUESO	THICK FILTER	FILTRE EPAIS	GROBER FILTER
RE3130263	POMO	KNOB	POMMEAU	KNOPF
RE3130264	MECANISMO	MECHANISM	MÉCANISME	MECHANISMUS

P313.132

PASAPURÉS / VEGETABLE SIEVE /
MOULIN À LÉGUMES / PÜRIERSIEB

REF	DESCRIPCIÓN	DESCRIPTION	DESCRIPTION	BESCHREIBUNG
RE3130263	POMO	KNOB	POMMEAU	FEINER FILTER
RE3130321	FILTRO FINO	THIN FILTER	FILTRE FIN	GROBER FILTER
RE3130322	FILTRO GRUESO	THICK FILTER	FILTRE EPAIS	KNOPF
RE3130324	MECANISMO	MECHANISM	MÉCANISME	MECHANISMUS



P602.015

BALANZA MECÁNICA / MECHANICAL SCALE /
BALANCE AUTOMATIQUE / MECHANISCHE WAAGE

REF	DESCRIPCIÓN	DESCRIPTION	DESCRIPTION	BESCHREIBUNG
RE602015	BANDEJA	TRAY	PLATEAU	TABLETT



P641.100

CARRO DE SERVICIO / TROLLEY /
CHARIOT DE SERVICE / SERVICEWAGEN

REF	DESCRIPCIÓN	DESCRIPTION	DESCRIPTION	BESCHREIBUNG
RE641101	TUBO	TUBE	TUBE	ROHR
RE641102	RUEDAS	WHEELS	ROUES	RÄDER
RE641103	BANDEJAS	TRAYS	PLATEAUS	TABLETTES
RE641104	ASAS	HANDLES	ANSES	GRIFFE



P81.000

ARMARIO CALIENTE / HOT CUPBOARD /
ARMOIRE CHAUDE / HEIZSCHRANK

REF	DESCRIPCIÓN	DESCRIPTION	DESCRIPTION	BESCHREIBUNG
RE81000	MANETA INOX CON LLAVE	INOX HANDLE WITH KEY	MANETTE INOX AVEC CLÉ	TÜRGRIF MIT SCHLÜSSEL ROSTFREIER STAHL



P830.001 / P830.002

EMBUDO DOSIFICADOR / CONFECTIONERY FUNNEL /
ENTONNOIR DOSEUR / DOSIERUNGSTRICHTER

REF	DESCRIPCIÓN	DESCRIPTION	DESCRIPTION	BESCHREIBUNG
RE8300010	BOQUILLA 4 mm	TUBE	DOUILLE	TÜLLE 4 MM
RE8300011	BOQUILLA 6 mm	TUBE	DOUILLE	TÜLLE 6 MM



P834.000

TAPA RECTANGULAR GN POLICARBONATO / GN POLYCARBONATE RECTANGULAR LID /
COUVERCLE RECTANGULAIRE GN POLYCARBONATE / RECHTECKIGER GN DDECKEL POLYCARBONAT

REF	DESCRIPCIÓN	DESCRIPTION	DESCRIPTION	BESCHREIBUNG
RE834000	ASAS	HANDLES	ANSES	GRIFFE



P835.000

CAMPANA GN POLICARBONATO / GN POLYCARBONATE DOME LID /
DÔME PROTECTION GN POLYCARBONATE / GN HAUBE POLYCARBONAT

REF	DESCRIPCIÓN	DESCRIPTION	DESCRIPTION	BESCHREIBUNG
RE835000	ASAS	HANDLES	ANSES	GRIFFE



P837.003

EXPOSITOR TARTAS ALUMINIO / ALUMINIUM CAKE STAND /
PRÉSENTOIR TARTES ALUMINIUM / TORTENSTÄNDER ALUMINIUM

REF	DESCRIPCIÓN	DESCRIPTION	DESCRIPTION	BESCHREIBUNG
RE837106	DISCO 20 cm	DISK 20 cm	DISQUE 20 cm	SCHEIBE 20 CM
RE837107	DISCO 26 cm	DISK 26 cm	DISQUE 26 cm	SCHEIBE 26 CM
RE837108	DISCO 32 cm	DISK 32 cm	DISQUE 32 cm	SCHEIBE 32 CM
RE837112	TORNILLO SUPERIOR	HEAD SCREW	VIS SUPÉRIEUR	KOPFSCHRAUBE
RE837113	PATA DE LA BASE CON TORNILLO	OUTSIDE FOOT WITH SCREW	PIED DE LA BASE AVEC VIS	STÄNDERFUSS MIT SCHRAUBE
RE837114	TUBO CENTRAL (UNA PARTE)	CONNECTION (PILLAR)	TUBE CENTRAL (UNE PARTIE)	ZENTRALROHR (EIN STÜCK)
RE837115	PATA CENTRAL	MIDDLE FOOT	PIED CENTRAL	ZENTRALFUSS

P837.005

EXPOSITOR TARTAS ALUMINIO / ALUMINIUM CAKE STAND /
PRÉSENTOIR TARTES ALUMINIUM / TORTENSTÄNDER ALUMINIUM

REF	DESCRIPCIÓN	DESCRIPTION	DESCRIPTION	BESCHREIBUNG
RE837106	DISCO 20 cm	DISK 20 cm	DISQUE 20 cm	SCHEIBE 20 CM
RE837107	DISCO 26 cm	DISK 26 cm	DISQUE 26 cm	SCHEIBE 26 CM
RE837108	DISCO 32 cm	DISK 32 cm	DISQUE 32 cm	SCHEIBE 32 CM
RE837109	DISCO 40 cm	DISK 40 cm	DISQUE 40 cm	SCHEIBE 40 CM
RE837110	DISCO 45 cm	DISK 45 cm	DISQUE 45 cm	SCHEIBE 45 CM
RE837112	TORNILLO SUPERIOR	HEAD SCREW	VIS SUPÉRIEUR	KOPFSCHRAUBE
RE837113	PATA DE LA BASE CON TORNILLO	OUTSIDE FOOT WITH SCREW	PIED DE LA BASE AVEC VIS	STÄNDERFUSS MIT SCHRAUBE
RE837114	TUBO CENTRAL (UNA PARTE)	CONNECTION (PILLAR)	TUBE CENTRAL (UNE PARTIE)	ZENTRALROHR (EIN STÜCK)
RE837115	PATA CENTRAL	MIDDLE FOOT	PIED CENTRAL	ZENTRALFUSS

P837.007

EXPOSITOR TARTAS ALUMINIO / ALUMINIUM CAKE STAND /
PRÉSENTOIR TARTES ALUMINIUM / TORTENSTÄNDER ALUMINIUM

REF	DESCRIPCIÓN	DESCRIPTION	DESCRIPTION	BESCHREIBUNG
RE837105	DISCO 16 cm	DISK 16 cm	DISQUE 16 cm	SCHEIBE 16 CM
RE837106	DISCO 20 cm	DISK 20 cm	DISQUE 20 cm	SCHEIBE 20 CM
RE837107	DISCO 26 cm	DISK 26 cm	DISQUE 26 cm	SCHEIBE 26 CM
RE837108	DISCO 32 cm	DISK 32 cm	DISQUE 32 cm	SCHEIBE 32 CM
RE837109	DISCO 40 cm	DISK 40 cm	DISQUE 40 cm	SCHEIBE 40 CM
RE837110	DISCO 45 cm	DISK 45 cm	DISQUE 45 cm	SCHEIBE 45 CM
RE837111	DISCO 50 cm	DISK 50 cm	DISQUE 50 cm	SCHEIBE 50 CM
RE837112	TORNILLO SUPERIOR	HEAD SCREW	VIS SUPÉRIEUR	KOPFSCHRAUBE
RE837113	PATA DE LA BASE CON TORNILLO	OUTSIDE FOOT WITH SCREW	PIED DE LA BASE AVEC VIS	STÄNDERFUSS MIT SCHRAUBE
RE837114	TUBO CENTRAL (UNA PARTE)	CONNECTION (PILLAR)	TUBE CENTRAL (UNE PARTIE)	ZENTRALROHR (EIN STÜCK)
RE837115	PATA CENTRAL	MIDDLE FOOT	PIED CENTRAL	ZENTRALFUSS



P868.001 / P868.002 / P868.003

DISPENSADOR A PRESIÓN / SQUEEZE DISPENSER /
DISTRIBUTEUR À PRESSION / DRUCKDOSSIERER

REF	DESCRIPCIÓN	DESCRIPTION	DESCRIPTION	BESCHREIBUNG
RE868123	TAPÓN ROJO	RED LID	EMBOUT ROUGE	ROTER DECKEL
RE868456	TAPÓN AMARILLO	YELLOW LID	EMBOUT JAUNE	GELBER DECKEL
RE868789	TAPÓN TRANSPARENTE	TRANSPARENT LID	EMBOUT TRANSPARENT	TRANSPARENTER DECKEL



P873.045 / P873.060 / P873.090

BARRA DE NOTAS DE ALUMINIO / ALUMINIUM CHECK MINDER /
BARRE PORTE-BONS EN ALUMINIUM / NOTIZLEISTE ALUMINIUM

REF	DESCRIPCIÓN	DESCRIPTION	DESCRIPTION	BESCHREIBUNG
RE873000	BOLAS	BALLS	BOULES	BÄLLE



P911 / P912 / P913

TABLAS DE CORTE / CUTTING BOARDS /
PLANCHES À DÉCOUPER / SCHNEIDEBRETTER

REF	DESCRIPCIÓN	DESCRIPTION	DESCRIPTION	BESCHREIBUNG
RE911000	PIÉS	FEET	PIEDS	FÜSSE



P918.000

LAVA-RACIONADOR ACERO INOXIDABLE / ST/STEEL SCOOP-WASHER /
RINCE-CUILLÈRES ACIER INOXYDABLE / PORTIONIERERSPÜLE ROSTFREIER STAHL

REF	DESCRIPCIÓN	DESCRIPTION	DESCRIPTION	BESCHREIBUNG
RE918001	GRIFO	TAP	ROBINET	HAHN
RE918002	CUBETA CON 1 AGUJERO	BAC WITH ONE HOLE	BAC AVEC UNE OUVERTURE	BEHÄLTER MIT 1 ABLAUF



P937.000

MÁQUINA MULTI-USOS / VERSATIL MACHINE /
MACHINE UNIVERSEL / MULTIFUNKTIONSMASCHINE

REF	DESCRIPCIÓN	DESCRIPTION	DESCRIPTION	BESCHREIBUNG
RE937001	CORTADOR PATATAS	FRENCH FRY CUTTER	COUPE FRITES	KARTOFFELSCHNEIDER
RE937002	CORTADOR MANZANAS	APPLE CUTTER	COUPE POMMES	APFELSCHNEIDER
RE937003	EXPRIMIDOR ZUMOS	JUICER	PRESS FRUITS	SAFTPRESSE



P945.037

HARINERO / FLOUR BIN /
TAMIS À FARINE / MEHLSIEB

REF	DESCRIPCIÓN	DESCRIPTION	DESCRIPTION	BESCHREIBUNG
RE945001	CAJÓN	DRAWER	TIROIR	SCHUBLADE

P945.050 / P945.051

HARINERO / FLOUR BIN /
TAMIS À FARINE / MEHLSIEB

REF	DESCRIPCIÓN	DESCRIPTION	DESCRIPTION	BESCHREIBUNG
RE945000	CAJÓN	DRAWER	TIROIR	SCHUBLADE



P954.013 / P954.015

EMBUDO CON FILTRO EXTRAÍBLE / FUNNEL WITH REMOVABLE FILTER /
ENTONNOIR AVEC FILTRE EXTRACTIBLE / TRICHTER MIT AUSTAUSCHBAREM SIEB

REF	DESCRIPCIÓN	DESCRIPTION	DESCRIPTION	BESCHREIBUNG
RE9541315	FILTRO	FILTER	FILTRE	FILTER

P954.020 / P954.025

EMBUDO CON FILTRO EXTRAÍBLE / FUNNEL WITH REMOVABLE FILTER /
ENTONNOIR AVEC FILTRE EXTRACTIBLE / TRICHTER MIT AUSTAUSCHBAREM SIEB

REF	DESCRIPCIÓN	DESCRIPTION	DESCRIPTION	BESCHREIBUNG
RE9542025	FILTRO	FILTER	FILTRE	FILTER



P964.001

ABRELATAS INDUSTRIAL / CAN OPENER /
OUVRE-BOÎTES PROFESSIONNEL / INDUSTRIELLER DOSENÖFFNER

REF	DESCRIPCIÓN	DESCRIPTION	DESCRIPTION	BESCHREIBUNG
RE964100	CUCHILLA	KNIFE	COUPEAU	KLINGE
RE964200	RODILLO	WHEEL	ROULEAU	RAD
RE964300	MECANISMO	MECHANISM	MÉCANISME	MESCHANISMUS



P975.000

CORTADOR DE PATATAS FRITAS / FRENCH FRY CUTTER /
COUPE FRITES / POMMESSCHNEIDER

REF	DESCRIPCIÓN	DESCRIPTION	DESCRIPTION	BESCHREIBUNG
RE975001	CUCHILLA 36 AGUJEROS	KNIFE 36 HOLES	COUPEAU 36 TROUS	SCHNEIDEGITTER 36 LÖCHER
RE975002	CUCHILLA 64 AGUJEROS	KNIFE 64 HOLES	COUPEAU 64 TROUS	SCHNEIDEGITTER 64 LÖCHER



P999.000

TRÍPODE PAELLERO / BASE FOR BURNER /
PIED POUR BRÛLEUR / STÄNDER FÜR GASBRENNER

REF	DESCRIPCIÓN	DESCRIPTION	DESCRIPTION	BESCHREIBUNG
RE999000	TAPÓN PLÁSTICO CUADRADO	SQUARE PLASTIC CAP	EMBOUT CARRÉ EN PLASTIQUE	QADRATISCHER PLASTIKSTÖPSEL



MX1000TXEE / MX1000XTPEE

BATIDORA ALTA POTENCIA / HI-POWERBLENDER /
BLENDER À HAUTE PUISSANCE / HOCHLEISTUNGSMIXER

REF	DESCRIPCIÓN	DESCRIPTION	DESCRIPTION	BESCHREIBUNG
CAC93XI RE503351	JARRA COPOLIÉSTER 1,4 L LLAVE DE TUERCA ACOPLAMIENTO	COPOLYESTER JAR 1,4 L COUPLING WRENCH	2 L BOL EN COPOLYESTER DE 1,4 L CLÉ D'ACCOUPEMENT	BEHÄLTER COPOLYESTER 1,4 L KUPPLUNGSSCHRAUBENSCHLÜSSEL



MX1100TXEE / MX1100TXSEE / MX1100XTPEE / MX1100XTPSEE

BATIDORA ALTA POTENCIA / HI-POWERBLENDER /
BLENDER À HAUTE PUISSANCE / HOCHLEISTUNGSMIXER

REF	DESCRIPCIÓN	DESCRIPTION	DESCRIPTION	BESCHREIBUNG
CAC93XI	JARRA COPOLIÉSTER 1,4 L	COPOLYESTER JAR 1,4 L	BOL EN COPOLYESTER DE 1,4 L	BEHÄLTER COPOLYESTER 1,4 L



MX1200TXEE

BATIDORA ALTA POTENCIA / HI-POWERBLENDER /
BLENDER À HAUTE PUISSANCE / HOCHLEISTUNGSMIXER

REF	DESCRIPCIÓN	DESCRIPTION	DESCRIPTION	BESCHREIBUNG
CAC93XI	JARRA COPOLIÉSTER 1,4 L	COPOLYESTER JAR 1,4 L	BOL EN COPOLYESTER DE 1,4 L	BEHÄLTER COPOLYESTER 1,4 L



MX1500TXEE / MX1500XTPEE

BATIDORA ALTA POTENCIA / HI-POWERBLENDER /
BLENDER À HAUTE PUISSANCE / HOCHLEISTUNGSMIXER

REF	DESCRIPCIÓN	DESCRIPTION	DESCRIPTION	BESCHREIBUNG
CAC93XI	JARRA COPOLIÉSTER 1,4 L	COPOLYESTER JAR 1,4 L	BOL EN COPOLYESTER DE 1,4 L	BEHÄLTER COPOLYESTER 1,4 L
RE028397	PANEL DE CONTROL	CONTROL PANEL	CONTRÔLE	KONTROLLPLATTE
RE029812	PANEL DE CONTROL	CONTROL PANEL	CONTRÔLE	KONTROLLPLATTE
RE029816	SOFT START PARA PANEL DE CONTROL	SOFT START CONTROL PANEL	SOFT START CONTROL PANEL	SANFTER START KONTROLLPLATTE

**ÍNDICE /
INDEX /
УКАЗАТЕЛЬ**

ARTÍCULO	PÁGINA
ABRELATAS INDUSTRIAL	135
ABRIDOR DE OSTRAS	134
AFILADOR DE CUCHILLOS.....	322
ALCUZA.....	120
ALFOMBRA DE BAR PAR ESCURRIR COPAS	518
ALFOMBRAS	147
ALU-PRO.....	37-39
ANILLO ANTI-GOTEO	521
ANTIALÉRGICO	30-31, 101-109
ANTIMICROBIAL	86-88
APLASTACARNES.....	119
ARAÑA.....	84
ARMARIO CALIENTE	341-342
ARO.....	260
ASADOR GRILL	59, 60
AZUCARERO.....	525
BALANZA.....	141-143
BAMBÚ NATURAL & MADERA	492-493
BANDA SELLADORA SILICONA.....	164
BANDEJA.....	70-73, 76, 366, 368-371, 380-386, 378, 470, 522, 541-542
BANDEJA ALUMINIO ANTIADHERENTE.....	70, 73
BANDEJA AUTO-SERVICE ACERO INOX	541-542
BANDEJA CAMARERO	522
BANDEJA FAST-FOOD	541
BANDEJA GASTRONORM.....	70
BANDEJA ISOTÉRMICA	544
BANDEJA OVAL.....	470
BANDEJA PASTERERÍA	72-73, 76, 389
BANDEJA PORTACUBIERTOS	542
BANDEJA PRESENTACIÓN	389
BANDEJAS ANTI-DESLIZANTES.....	505, 522
BANDEJAS FIBRA DE VIDRIO	541
BANDEJAS. CUBIC.....	436
BAÑO MARÍA.....	24, 334, 340, 409, 411, 462
BAR KEEP®	523
BARRA DE NOTAS	120
BASE PIZZA	77
BATERIA COLOR	32, 404-409
BATERÍA IDEA	34-36
BATERIA PRESENTACIÓN.....	416-421
BATIDOR	107, 245
BATIDORA SOBRE MESA.....	306
BATIDORAS DE VASO	311-321
BATIDORAS PLANETARIAS.....	306-307
BLACK FIRST	60
BLACK PRO	58-59
BLACK SERIES.....	41, 75
BOL.....	106, 364, 366, 369, 372, 381, 402, 467-469, 544
BOL DOBLE PARED.....	106, 467-469
BOL ESTRIDADO INCLINADO	467
BOQUILLA.....	265-268
BOQUILLA POLICARBONATO	268
BOTELLA BAR.....	523
BRAZOS TRITURADORES.....	308-310
BUFFET CUBIC. CARRO BUFFET.....	422-447
BUFFET CUBIC. CUBOS Y ESTANTES	438
BUFFET CUBIC. MUEBLE EXPOSITOR.....	437, 440-442
CACEROLA ALUMINIO	38
CACEROLA COOL • LINE.....	32

ARTÍCULO	PÁGINA
CACEROLA IDEA.....	35-36
CACEROLA INOX-PRO	22
CACEROLA TOP LINE.....	29
CACEROLA VIOLET.....	30-31
CACILLO.....	82, 91, 106, 388, 473-477
CAFETERA.....	525-526
CAJA CONDIMENTOS	519
CAJA GN BAMBU.....	449
CALDERO.....	243
CALENTADOR DE PLATOS	343
CALENTADOR INDUCCIÓN MIRAGE.....	289-290
CALENTADORES	324-325, 333-334, 409, 411
CARRO CON GUIAS	204-209, 211-212
CARRO CON GUIAS, DESMONTABLE	205-207
CARRO CON GUIAS, ENCASTRABLE	205-207
CARRO CON SUPERFÍCIE DE TRABAJO	211
CARRO DE MADERA.....	444-447
CARRO DE PLÁSTICO.....	200, 214-215
CARRO DE SERVICIO DESMONTABLE.....	202
CARRO DE SERVICIO EN ALUMINIO.....	200
CARRO DE SERVICIO INOXIDABLE	201-203
CARRO DESCONGELACIÓN	208
CARRO DESEMBARACE	200, 203
CARRO DOBLE PARA BANDEJAS FAST-FOOD	209
CARRO GASTRONORM DESCONGELACIÓN.....	208
CARRO GUERIDON	446
CARRO HIELO.....	215
CARRO PARA CARGAS PESADAS.....	211
CARRO PARA CESTAS.....	212
CARRO PARA PLATOS AJUSTABLE	214
CARRO PORTA CUBETAS GASTRONORM.....	204-208
CARRO PORTACUBIERTOS	447, 210, 541
CASCANUECES.....	481
CAYENNE®	330-334
CAZO ALUMINIO	39
CAZO BOMBEADO	24, 39, 43, 243
CAZO COOL • LINE	32
CAZO IDEA	35-36
CAZO INOX-PRO	23-24
CAZO TIPO FRANCÉS.....	23
CAZO VIOLET	30-31
CAZOS DE MEDIDAS	145
CAZUELA ALUMINIO FUNDICIÓN	41
CAZUELA BLACK SERIES.....	41
CEDAZO.....	252
CENICERO	403, 506
CEPILLO METÁLICO	120
CESTA GRANDES BANDEJAS.....	190
CESTA PAN	495-496
CESTA PARA BANDEJAS ISOTÉRMICAS	190
CESTA PARA CUBIERTOS.....	186, 196
CESTA REJADA	452
CESTA UNIVERSAL.....	186, 196
CESTAS ABIERTAS	180-183
CESTAS CERRADAS	184-185
CESTAS PARA PLATOS.....	187-190, 196
CESTAS POLIPROPILENO	496-499
CESTILLO PARA CUBIERTOS.....	186
CHAFING, ACCESORIOS	457, 462-463

ARTÍCULO	PÁGINA
CHAFING DISH.....	456-461
CHAFING DISHEES ECONOMICOS	461
CHAFING DISHES INTRIGUE	456-457
CHAFING DISHES NEW YORK, NEW YORK.....	458-459
CHAMPAÑERA.....	512-514
CHAMPAÑERA, COMPLEMENTOS.....	520-521
CINTA PVC PARA MOUSSE.....	261
CLIP DE IDENTIFICACIÓN.....	178, 184-185, 189-190
COCTEL	516-517
COCTELERA	516
COLADOR.....	112-114
COLADOR BOLA INFUSIONES.....	527
COLADOR CHINO.....	113
COLADOR GUSANILLO	517
COLAPASTAS.....	26
COLECTIVIDADES.....	541-542, 544-545
CONJUNTOS COMPLETOS DE ESTANTERIAS	225-231
CONJUNTOS. CUBIC.....	430-433
COOL • LINE.....	32, 404-409
COPA HELADO	239
CORTADOR / DESCORAZONADOR MANZANAS.....	135
CORTADOR DE CEBOLLAS.....	129
CORTADOR DE LECHUGA	128
CORTADOR DE PATATAS FRITAS.....	127
CORTADOR EN CUBOS	134
CORTADOR QUESOS	134
CORTADOR SECCIONADOR.....	130
CORTADOR TOMATES.....	133
CORTADORA ELÉCTRICA DE FIAMBRES.....	307
CORTADOR-REBANADOR.....	125-126
CORTAHUEVOS	135
CORTAPASTAS	247, 259
CRÊPERA.....	297
CUBERTERO PARA CARRO SERVICIO.....	203
CUBETA GASTRONORM SIN BPA.....	168-169
CUBETAS HELADERÍA.....	240
CUBITERA DE PLÁSTICO.....	512
CUBO CHAMPÁN	512-514
CUBO CON BASE.....	514
CUBO HIELO.....	515
CUCHARA	84-85, 90, 91, 107, 246, 388, 473-478
CUCHARA BATIDORA.....	517
CUCHARA SERVICIO	85, 107
CUCHILLA/RODILLO DE RECAMBIO	135
CUCHILLO.....	473, 475, 478
CUSCUSERA.....	25
DISPENSADOR A PRESIÓN.....	116-118
DISPENSADOR BOLSAS TE Y AZÚCAR. CUBIC.....	437
DISPENSADOR CON CONTROL DE PORCIONES.....	254
DISPENSADOR DE CEREALES	464
DISPENSADOR DE ZUMOS	459, 464
DISPENSADOR LECHE	464
DISPENSADOR ZUMOS. CUBIC.....	434, 443
DISPENSADORES.....	254, 434, 443, 459, 464
DOSIFICADOR LICOR	517
ELEGANCE	375
ELEMENTO ELÉCTRICO CHAFING DISH.....	463
EMBUDO.....	115, 253
EMBUDO DOSIFICADOR.....	253

ARTÍCULO	PÁGINA
ENFRIADOR BOTELLAS BUFFET. CUBIC	437
ENFRIADOR ISOTÉRMICO.....	515
ENSALADERA ACRÍLICA	471
ESCAMADOR.....	120
ESCURRIDERA.....	114
ESPÁTULA	83, 91, 98, 107, 246, 473-478
ESPÁTULA PARA UNTAR.....	99-100
ESPECIEROS.....	118
ESPUMADERA	83-84, 91, 473-476
ESTACION BUFFET	465
ESTACION BUFFET PARA COCINA INDUCCION	465
ESTACION BUFFET TRINTANCHE	339
ESTANTERÍAS	218-235
EXPOSITOR BOLLERIA	454-455
EXPOSITOR DE TARTAS.....	252
EXPOSITOR GASTRONORM.....	399
EXPOSITOR TRES NIVELES. CUBIC.....	434
EXPOSITORES	453
EXPRIME LIMONES.....	517
EXPRIMIDOR	131
FLANERO.....	262, 271
FLAP IDENTIFICACIÓN.....	177
FLAP-RACK®	174-191
FONDOS PERFORADOS GASTRONORM....	157, 158, 161, 167, 169, 171, 208
FREIDORA.....	292-293
FUEL PARA CHAFING DISH	463
FUENTE FONDUE CHOCOLATE.....	340
FUENTE HONDA CÓNICA.....	244
FUENTE OVAL	364, 367-368, 385-386, 470
FUNDA PROTECTORA DE VINILO.....	214
FUNDAS DESECHABLES POLIETILENO DISPENSADOR	211
GANCHO.....	115
GASTRONORM FONDO DIFUSOR.....	165
GASTRONORM INOXIDABLE.....	156-162, 165
GASTRONORM MELAMINA.....	394-399
GASTRONORM POLICARBONATO.....	166-167
GASTRONORM POLIPROPILENO	170-171
GASTRONORM VIOLET	172
GEL LUBRICANTE SANITARIO.....	136
GOFRERAS	297
GRILL.....	304
GUANTES PROTECCIÓN.....	146
HELADERÍA	344-358, 238-240
HERVIDOR DE ARROZ.....	296
HORNOS.....	296
INDUCCIÓN 3-D MIRAGE	326-327
INOX-PRO	20-26
INSERTOS.....	286, 327, 290, 458-459
JARRA	530-531
JARRA AGUA	530-531
JARRA DE MEDIDAS	145
JARRA PARA INFUSIONES.....	527
JARRA POLICARBONATO	530-531
JARRA TERMO	528-529
JARRA VIOLET.....	320
LÁMPARAS MANTENEDORAS.....	336-338
LAVA-RACIONADOR ACERO INOX.....	240
LECHERA.....	524-526
LIBRADOR	244

ARTÍCULO	PÁGINA
LICUADORAS.....	322
LIDSAVER®.....	534-539
LLAUNAS PRESENTACIÓN.....	489
MANDOLINAS.....	136
MANGAS PASTELERAS.....	263-264
MANOPLA.....	146
MANTA ENFRIADORA.....	513
MANTECADORA.....	354-357
MANTEL ANTIDESLIZANTE PARA BANDEJA.....	522
MANTELES INDIVIDUALES.....	500-501
MARCADOR DE TARTAS.....	249
MARCADORES TIZA.....	483
MARCOS PARA BANDEJAS.....	72
MEDITERRANEAN.....	376
MELAMINA PRESENTACIÓN.....	360-403
MELAMINA SLIM.....	396-397
MESA DE CORTE.....	140
MESITA BUFFET. CUBIC.....	437
MICRO-ONDAS.....	295
MINIATURAS ALUMINIO FUNDICIÓN.....	41
MINIATURAS HIERRO FUNDIDO.....	486-487
MINIATURAS MELAMINA.....	401-402
MIRAGE®.....	326-327, 289-290
MIRAMAR® BATERÍA PRESENTACIÓN.....	416-421
MIRAMAR® PLANTILLAS.....	420-421
MOLDE CAKE.....	255, 262, 271
MOLDE FORMA CORAZÓN.....	261
MOLDE FORMA LÁGRIMA.....	261
MOLDE HEXAGONAL.....	261
MOLDE HUEVO.....	119
MOLDE MEDIA CAÑA.....	262
MOLDE NIDO.....	84
MOLDE OVAL.....	257, 261
MOLDE PARA PIZZA.....	77
MOLDE SEMIESFÉRICO.....	244
MOLDES "FLEXIPAN".....	274-281
MOLDES DE SILICONA.....	269-273
MOLDES PASTELERÍA.....	255-258, 260-262, 269-281
MOLDES SILICONA 600 X 400.....	272-273
MOLINILLO PIMENTA.....	502
MOLINILLO SAL.....	502
MULTIMETAL.....	43, 57
NEW YORK®.....	458-459
NÚMERO MESA.....	504
OLLA ALUMINIO.....	38
OLLA CON GRIFO.....	26
OLLA COOL • LINE.....	32, 407
OLLA ELÉCTRICA.....	334
OLLA IDEA.....	35
OLLA INOX-PRO.....	22, 26
OLLA TOP LINE.....	29
PAELLERA ACERO ESMALTADO.....	64
PAELLERA ALUMINIO.....	55
PAELLERA INOX-PRO.....	22
PAELLERA TOP LINE.....	29
PAELLERA VALENCIANA.....	64
PAELLERO ESMALTADO GAS.....	65
PALA CHIPS.....	97
PALA FAST-FOOD.....	99

ARTÍCULO	PÁGINA
PALA PASTELES.....	100
PALA PESCADO.....	83, 99
PALA PIZZA.....	78
PALA PRESENTACIÓN.....	390
PANEL INFORMACIÓN.....	482
PAÑO SILICONA.....	146
PAPEL SILICONADO.....	78
PAPELERA SOBREMESA.....	506
PARRILLA PLANA CON ASAS ALUMINIO.....	75
PASAPURÉS.....	115
PERFILES DIVISORIOS.....	157, 414
PINCEL.....	248
PINCHANOTAS.....	505
PINCHO / BROCHETA.....	505
PINCHOS. SOPORTE PRESENTACIÓN. CUBIC.....	435
PINZA.....	91, 93-97, 106, 478-481, 493, 517
PINZA BUFFET.....	94-95, 479-480
PINZA CHARCUTERÍA.....	481
PINZA PARA MARISCO.....	481
PINZA REPOSTERÍA.....	480
PINZA SERVICIO.....	479-481
PINZAS PARA EMPLATAR.....	93
PIZARRAS.....	483
PIZARRAS PRESENTACIÓN.....	490-491
PLACA "RESERVADO".....	504
PLACA ADAPTADORA ANGULAR.....	453
PLACA CALIENTE.....	338, 240
PLACA ENFRIADORA.....	471
PLACA PROHIBIDO FUMAR.....	504
PLACAS INDUCCIÓN.....	284-291
PLANTILLAS.....	420-421
PLATOS.....	364-369, 373, 374, 376-379, 387, 544
PLATOS COLORES.....	377
PORCIONADOR APRETABLE.....	238-239
PORTA BROCHETAS.....	505
PORTA CUBIERTOS.....	447, 203, 210, 541-542
PORTAMENÚS.....	508
PORTASALADOS / PORTASALSAS.....	503
PORTATARJETAS.....	508
POSTE SEPARACIÓN.....	482
PRESENTADOR BOLS MELAMINA. CUBIC.....	439
PRESENTADOR CUBETAS GN.....	163, 399
PROCESADOR DE ALIMENTOS.....	306-307
PROCESADOR VERSÁTIL MANUAL.....	135
PROCESADORES MANUALES DE ALIMENTOS.....	121-136
PROTECTOR ACRÍLICO ANTI-ALIENTO.....	462
PROTECTOR ANTI-ALIENTO.....	462
PUJADAS 1921. HIERRO DE FUNDICIÓN ULTRALIGERO INDUCCIÓN.....	61
QUEMADOR ELÉCTRICO.....	251
RACIONADOR DE HELADO.....	90, 107, 238-239
RALLADOR.....	110-111
RASQUETA.....	99-100, 120, 249
REBANADORA DE FRUTAS Y VERDURAS.....	129
RECIPIENTE PARA SALSAS.....	371, 373, 400, 402
RECOGEMIGAS.....	504
RECOGEVERDURAS.....	140
REJILLAS GN.....	74
REJILLAS PASTELERÍA.....	74, 254
RELOJ DE COCINA DIGITAL.....	143

ARTÍCULO	PÁGINA
REMO.....	120
RETERMALIZADOR	326-333
RETERMALIZADOR RETRO	328-329
RETERMALIZADORES / CALENTADORES ALIMENTOS	326-333
RODILLO	247-248
RULETA CORTAPIZZAS	99
RUSTIDERA	68-69, 75
SACACORCHOS.....	521
SACACORCHOS DE PARED	521
SALAMANDRA	296
SALSERA.....	503
SALSERA BORDE ONDULADO	503
SARTÉN "LIONESA"	63
SARTÉN ACERO INOXIDABLE	50-52
SARTÉN ALUMINIO	54-56
SARTÉN ALUMINIO FUNDICIÓN	58-59
SARTÉN BLACK PRO	58-59
SARTÉN CRÊPES.....	56, 59, 60, 63
SARTÉN HONDA ESMALTADA CON ASAS	64
SARTÉN IDEA.....	52
SARTÉN MULTIMETAL.....	57
SARTÉN PARA BLINIS	56
SARTÉN STEEL PRO	61
SARTÉN VIOLET.....	56
SARTENES.....	48-63
SARTENES COOL • LINE	408
SAUTEX ALUMINIO.....	39
SAUTEX INOX-PRO.....	24
SERVILLETERO	507
SERVILLETERO. CUBIC	437
SIGNATURE	195-197
SOLUCIONES DE DISPENSADO	534-539
SOPERA	471
SOPLETE COCINA	251
SOPORTE CUCURUCHO	239
SOPORTE MÁRMOL EXHIBICIÓN	393
SOPORTE MESA BANDEJA MARISCO	505
SOPORTE PARA BANDEJAS DE GRAN TAMAÑO	505
SOPORTE PARA BANDEJAS PORTACUBIERTOS GN	542
SOPORTE PARA CHINO O EMBUDO	113
SOPORTE PARA CUBO CHAMPÁN	513
SOPORTE PARA MANGAS PASTELERAS	264
SOPORTE PARA NÚMEROS	504
SOPORTE PARA PINCHOS. CUBIC	435
SOPORTE PARA PIZZAS	78
SOPORTE PARA TABLAS DE CORTE.....	163
SOPORTE PRESENTACIÓN MADERA BLANCA.....	391
SOPORTE PRESENTACIÓN PIZARRA-MÁRMOL	393
SOPORTE TAPAS GN	163
SPOODLE®	86-88, 106
STONE	374
SUPER PAN 3®	159-161
SUPER PAN® SUPER SHAPES	412-414
TABLA DE CORTE	137-140
TABLA DE CORTE VIOLET.....	140
TAPA BATERIA.....	23, 29, 30, 39
TAPA GN	160, 162, 167, 169, 170, 172
TAPA INOX PARA PLATOS.....	509

ARTÍCULO	PÁGINA
TAPA INOX-PRO	23
TAPA PARA BOL DOBLE PARED.....	467
TAPA PARA CESTA.....	186
TAPA PLATOS	509
TAPA PLATOS PLÁSTICO	509
TAPA POLINORM®	162, 167, 170, 172
TAPA TAZA DESAYUNO	544
TAPA VIOLET.....	30
TAPAS GN TRANSPARENTES	455
TAPETE DE SILICONA	78
TAPÓN CHAMPÁN	520
TAPÓN UNIVERSAL.....	520
TAZA	388
TENEDOR.....	85, 91, 120, 473-475
TERMO CON DOSIFICADOR	528-529
TERMÓMETRO	143-145
TERRACOTA.....	371-373
TETERA	525-527
TETERA CON FINLTRO	527
TOP LINE.....	28-29
TOSTADORA	298-302
TRÍPODE PAELLERO.....	65
T-VERSION	178-183
UTENSILIOS DE SERVICIO	473-481
UTENSILIOS MANGO MADERA.....	100
VAPORERA INOX-PRO	26
VASO	376, 545
VERSATIL MACHINE.....	131
VIOLET COLLECTION	30-31, 101-109, 172
VITRINAS PRESENTACIÓN.....	454-455
WOK ACERO	63
WOK BLACK SERIES	59
WOK INOX	52
WOK MULTIMETAL	57
WOK STEEL PRO.....	61

ARTÍCULO	PÁGINA
ADAPTOR BAR	157, 414
ADJUSTABLE DISH CADDY	214
AIR POT	528-529
ALLERGEN-FREE	30-31, 101-109
ALU-PRO	37-39
ANGLED ADAPTOR PLATE	453
ANTIMICROBIAL	86-88
ANTI-SKID MAT TRAY ACCESSORIES	522
APPLE CORER	135
ASHTRAY	403, 506
BAIN MARIE	24, 334, 340, 409, 411, 462
BAKERY DISPLAY CASES	454-455
BAR KEEP	523
BAR KEEP®	523
BAR MATS	518
BARRIER	482
BASE FOR BURNER	65
BASKET, BREAD	495-496
BASKET, WIRE	452
BILL SPIKE	505
BIRD NEST MOULD	84
BLACK FIRST	60
BLACK PRO	58-59
BLACK SERIES	41, 75
BLACK STEEL SPANISH PAELLA PAN	64
BLACKBOARDS	483
BLENDERS	311-321
BOILER	243
BOWL	106, 364, 366, 369, 372, 381, 402, 467-469, 544
BOWLS, ANGLED BEEHIVE	467
BOWLS, COVERS FOR DOUBLE WALL ROUND	467
BOWLS, DOUBLE WALL INSULATED SERVING	106, 467-469
BPA FREE GASTRONORM PAN	168-169
BREATH GUARDS, MOBILE	462
BREATH GUARDS, MOBILE ACRYLIC	462
BRUSH	248
BUCKET WITH BASE	514
BUCKET-HOLDER STAND	513
BUFFET CUBIC. BUFFET TROLLEY	422-447
BUFFET CUBIC. CUBES & SHELVES	438
BUFFET CUBIC. DISPLAY CASE	437, 440-442
BUFFET FUEL	463
BUFFET STATION	339
BUFFET STATION, CONTOURED	465
BUFFET STATION, INDUCTION	465
BUFFET WINE COOLER. CUBIC	437
BUTTER SPREADER	99-100
CAKE DIVIDER	249
CAKE MOULD	255, 262, 271
CAKE SERVER	100
CAKE STAND	252
CAN OPENER	135
CARAMEL CREAM MOULD	262, 271
CARAMELIZER	251
CARD HOLDER	508
CARRY-SKEWERS	505
CASSEROLE	41
CASSEROLE BLACK SERIES	41
CAST IRON MINIATURE	486-487

ARTÍCULO	PÁGINA
CAYENNE®	330-334
CAYENNE® WARMERS & RETHERMALIZERS	326-333
CEREAL DISPENSER	464
CHAFERS	456-461
CHAFERS ACCESSORIES	457, 462-463
CHAFERS, ECONOMY	461
CHAFERS, INTRIGUE®	456-457
CHAFERS, NEW YORK®	458-459
CHALKMARKERS	483
CHAMPAGNE BUCKET	512-514
CHAMPAGNE STOPPER	520
CHECK MINDER	120
CHEESE CUTTER	134
CHINESE COLANDER	113
CHIP BAGGER	97
CHOCOLATE FOUNTAIN	340
CLEAR GN LIDS	455
CLEARING TROLLEY	200, 203
CLIP TAGS	178, 184-185, 189-190
COCKTAIL SERVICE	516-517
COCKTAIL SPOON	517
COCKTAIL STRAINER	517
COFFE MAKER	527
COFFE POT	525-526
COLANDER	112-114
COLANDER	114
COLORED COOKWARE	32, 404-409
COMPLETE KITS OF SHELVING	225-231
CONDIMENT HOLDER	519
CONFECTIONERY FUNNEL	253
CONICAL SAUCEPAN	24, 39, 43, 243
COOL • LINE	32, 404-409
COOLING PLATE	471
CORKSCREW	521
CORNET STAND	239
COUNTER-TOP DISPENSER	447, 210, 541
COUNTERTOP MIXERS	306
COUSCUS SET	25
COVERS, PLASTIC PLATE	509
COVERS, PLATE	509
CREAMER	524-526
CRÊPE MAKER	297
CUBE CUTTER	134
CUP	388
CUTLERY BIN	542
CUTLERY DISPENSER FOR SERVING TROLLEY	203
CUTTING BOARD	137-140
CUTTING BOARD TABLE	140
CUTTING BOARD VIOLET	140
DICER & SLICER	125-126
DISHES	364-369, 373, 374, 376-379, 387, 544
DISHES, COLORED	377
DISPENSERS	254, 434, 443, 459, 464
DISPENSING SOLUTIONS	534-539
DISPLAY CABINET	454-455
DISPLAY COOKWARE	416-421
DISPLAY SLATES	490-491
DISPLAY STANDS	453
DISPLAY TRAY	389

ARTÍCULO	PÁGINA
DISPLAYER MELAMINE BOWLS. CUBIC.....	439
DISPOSABLE COVER	211
DOUBLE COUNTER-TOP CUTLERY DISPENSER GN	542
DOUBLE CUTTER	247, 259
DOUBLE FAST-FOOD TRAY TROLLEY.....	209
DOUBLE WALL INSULATED COOLER.....	515
DREGDERS.....	118
DROP-IN	286, 327, 290, 458-459
EGG RING.....	119
EGG SLICER.....	135
ELECTRIC HEATING UNIT FOR CHAFING DISH	463
ELECTRIC SLICING MACHINE	307
ELEGANCE	375
ENAMELLED GAS BURNIER.....	65
ENAMELLED STEEL PAELLA PAN.....	64
FAST-FOOD TURNER.....	99
FISH SCALER	120
FISH TURNER	83, 99
FLAP IDENTIFICATION	177
FLAP-RACK®	174-191
FLARED SAUCE CUPS.....	503
FLATWARE BASKET.....	186
FOOD-PROCESSORS.....	306-307
FORK	85, 91, 120, 473-475
FRENCH FRY CUTTER.....	127
FRENCH STYLE SAUCEPAN	23
FRUIT & VEGETABLE SLICER.....	129
FRY PAN "LYONNAISE".....	63
FRY PAN ALUMINIUM	54-56
FRY PAN BLACK SERIES	58-59
FRY PAN BLINIS	56
FRY PAN CAST ALUMINIUM.....	58-59
FRY PAN COOL • LINE.....	408
FRY PAN CRÊPE	56, 59, 60, 63
FRY PAN DEEP ENAMELLED WITH HANDLES	64
FRY PAN IDEA	52
FRY PAN MULTIMETAL	57
FRY PAN PUJADAS 1921.....	61
FRY PAN ST/STEEL	50-52
FRY PAN VIOLET	56
FRY PANS	48-63
FRYER	292-293
FUNNEL.....	115, 253
GASTRONORM CONTAINERS (MELAMINE).....	394-399
GASTRONORM CONTAINERS (POLYCARBONATE).....	166-167
GASTRONORM CONTAINERS (POLYPROPYLENE)	170-171
GASTRONORM FOR DEFROST TROLLEY	208
GASTRONORM SANDWICH BOTTOM	165
GASTRONORM ST/STEEL.....	156-162, 165
GASTRONORM STAND.....	399
GASTRONORM VIOLET	172
GLASS	376, 545
GLOVES.....	146
GN BAMBOO BOX	449
GN TRANSPORT TROLLEY.....	204-208
GRANITE-SLATE DISPLAYER.....	393
GRATER.....	110-111
GRAVY BOAT	503
GRID GN.....	74

ARTÍCULO	PÁGINA
GRID PASTRY	74, 254
GRILL.....	59, 60
GRILL.....	304
HEART RING MOULD	261
HEATING LAMPS	336-338
HEATING PLATE.....	338, 240
HEMISPHERICALD MOULD	244
HEXAGON MOULD	261
HOOK.....	115
HOT CUPBOARD	341-342
HOT TRAY WARMER	343
HOT-PLATE WITH HANDLES	75
ICE BUCKET	515
ICE CADDY.....	215
ICE CREAM CONTAINERS	240
ICE CREAM CUP	239
ICE CREAM SCOOP.....	90, 107, 238-239
ICE-CREAM CHURN.....	354-357
ICE-CREAM PARLOUR.....	344-358, 238-240
IDEA COOKWARE.....	34-36
INDUCTION HOBS	284-291
INFORMATION SIGN.....	482
INOX-PRO	20-26
INSTITUTIONS.....	541-542, 544-545
INSULATED COFFE POT	528-529
ISOTHERMAL TRAY	544
JIGGER	517
JUICE DISPENSER	459, 464
JUICE DISPENSER. CUBIC.....	434, 443
JUICE EXTRACTORS.....	322
KITCHEN BOWL.....	244
KITCHEN TIMER ALARM	143
KITS. CUBIC.....	430-433
KNIFE	473, 475, 478
KNIFE SHARPENER	322
KNIVE / WHEEL (SPARE PART).....	135
LADLE	82, 91, 106, 388, 473-477
LARGE TRAY HOLDER.....	505
LEMON SQUEEZER	517
LID FOR BREAKFAST CUP	544
LID FOR COOKWARE.....	23, 29, 30, 39
LID GN.....	160, 162, 167, 169, 170, 172
LID INOX-PRO	23
LID RACKS.....	186
LID VIOLET.....	30
LIDSAVER®.....	534-539
LOBSTER CRACKER.....	481
MANDOLINES	136
MANUAL FOOD PROCESSORS	121-136
MARBLE OBLONG DISPLAY PLATE	393
MATS	147
MEASURING CUPS.....	145
MEASURING JUG.....	145
MEAT BEATER.....	119
MEDITERRANEAN.....	376
MELAMINE FOR PRESENTATION.....	360-403
MELAMINE MINIATURES	401-402
MELAMINE SLIM	396-397
MENU HOLDER.....	508

ITEM	PAGE
METALLIC BRUSH.....	120
MICRO-WAVES.....	295
MILK DISPENSER.....	464
MINIATURE CAST ALUMINIUM.....	41
MIRAGE®.....	326-327, 289-290
MIRAGE® 3D INDUCTION.....	326-327
MIRAGE® INDUCTION WARMER.....	289-290
MIRAMAR® DISPLAY COOKWARE.....	416-421
MIRAMAR® TEMPLATES.....	420-421
MIXERS.....	306-307
MIXING PADDLE.....	120
MOULDS "FLEXIPAN".....	274-281
MULTIMETAL.....	43, 57
NAPKIN HOLDER.....	507
NAPKIN HOLDER. CUBIC.....	437
NATURAL BAMBOO & WOOD.....	492-493
NEW YORK®.....	458-459
NON SLIP SERVING TRAY.....	505, 522
NON-SMOKING SING.....	504
NON-STICK SILICONE MAT.....	78
NUMBER CARD HOLDER.....	504
NUT CRACKER.....	481
OIL POURER.....	120
ONION CUTTER.....	129
OVAL MOULD.....	257, 261
OVAL SERVING DISH.....	364, 367-368, 385-386, 470
OVAL SERVING TRAY.....	470
OVEN MITT.....	146
OVENS.....	296
OYSTER OPENER.....	134
PAELLA PAN ALUMINIUM.....	55
PAELLA PAN INOX-PRO ST/STEEL.....	22
PAELLA PAN TOP LINE.....	29
PAN BAND.....	164
PASTA COLANDER.....	26
PASTRY BAGS.....	263-264
PASTRY MOULDS.....	255-258, 260-262, 269-281
PASTRY TORCH.....	251
PEPPER MILL.....	502
PERFORATED BOTTOMS GASTRONORM 157, 158, 161, 167, 169, 171, 208	
PIZZA MOULD.....	77
PIZZA PAN.....	77
PIZZA PAN RACK.....	78
PIZZA PEEL.....	78
PIZZA WHEEL.....	99
PLACE MATS.....	500-501
PLASTIC CHAMPAGNE BUCKET.....	512
PLATING TONGS.....	93
POLINORM® LID.....	162, 167, 170, 172
POLYCARBONATE TUBE.....	268
POLYPROPYLENE BASKETS.....	496-499
PORTION CONTROL DISPENSER.....	254
POT-GRABBER.....	146
PUJADAS 1921. ULTRALIGHT WEIGHT CAST IRON INDUCTION.....	61
PVC RIBBON.....	261
RACK (BIG TRAYS).....	190
RACK (CLOSED SYSTEM).....	184-185
RACK (DISHES).....	187-190, 196
RACK (FLATWARE).....	186, 196

ITEM	PAGE
RACK (ISOTHERMAL TRAYS).....	190
RACK (OPENED SYSTEM).....	180-183
RACK (UNIVERSAL).....	186, 196
RAMEKIN.....	371, 373, 400, 402
RECTANGLE FOR BAKING SHEETS.....	72
REITHERMALIZER RETRO.....	328-329
REITHERMALIZERS.....	326-333
RICE COOKER.....	296
RING.....	260
RING STOP DROP.....	521
ROAST PAN.....	68-69, 75
ROLLING PIN.....	247-248
SALAD BOWL.....	471
SALAD CUTTER.....	128
SALAMANDER.....	296
SALT MILL.....	502
SANITARY GEL LUBRICANT.....	136
SAUCE PAN ALUMINIUM.....	39
SAUCE PAN COOL • LINE.....	32
SAUCE PAN IDEA.....	35-36
SAUCE PAN INOX-PRO ST/STEEL.....	23-24
SAUCE POT ALUMINIUM.....	38
SAUCE POT COOL • LINE.....	32
SAUCE POT IDEA.....	35-36
SAUCE POT ST/STEEL INOX-PRO.....	22
SAUCE POT TOP LINE.....	29
SAUCE POT VIOLET.....	30-31
SAUCEPAN VIOLET.....	30-31
SAUTÉ PAN ALUMINIUM.....	39
SAUTÉ PAN INOX-PRO.....	24
SCALE.....	141-143
SCOOP.....	244
SCRAPER.....	99-100, 120, 249
SERVER.....	530-531
SERVER VIOLET.....	320
SERVER, POLICARBONATE.....	530-531
SERVING PADDLE.....	390
SERVING TOOLS.....	473-481
SERVING TRAY.....	522
SERVING TRAY. CUBIC.....	436
SHAKER.....	516
SHELVING.....	218-235
SIEVES.....	252
SIGNATURE.....	195-197
SILICONE MOULDS.....	269-273
SILICONE MOULDS 600 X 400.....	272-273
SILICONIZED BAKING PAPERS.....	78
SKEVER.....	505
SKEWER SERVING SUPPORT. CUBIC.....	435
SKEWER SUPPORT. CUBIC.....	435
SKIMMER.....	83-84, 91, 473-476
SNACK BOWL SET.....	503
SOUP KETTLE.....	334
SOUP TOUREEN.....	471
SPATULA.....	83, 91, 98, 107, 246, 473-478
SPOODLE®.....	86-88, 106
SPOON.....	84-85, 90, 91, 107, 246, 388, 473-478
SPOONS.....	85, 107
SQUEEZE DISHER.....	238-239

ITEM	PAGE
SQUEEZER.....	131
SQUEEZE DISPENSER.....	116-118
ST/STEEL SCOOP WASHER.....	240
ST/STEEL SELF-SERVICE TRAY.....	541-542
STAINLESS STEEL PLATE COVERS.....	509
STAND FOR CHINESE COLANDER OR FUNN.....	113
STAND FOR CUTTING BOARDS.....	163
STAND FOR GN CONTAINERS.....	163, 399
STAND FOR GN LIDS.....	163
STAND FOR SEA FOOD TRAY.....	505
STEAM POT INOX-PRO.....	26
STICK BLENDERS.....	308-310
STOCK POT ALUMINIUM.....	38
STOCK POT COOL • LINE.....	32, 407
STOCK POT IDEA.....	35
STOCK POT INOX-PRO.....	22, 26
STOCK POT TOP LINE ST/STEEL.....	29
STOCK POT WITH TAP.....	26
STONE.....	374
SUGAR BOWL.....	525
SUPER PAN 3®.....	159-161
SUPER PAN® SUPER SHAPES.....	412-414
SUPPORT FOR CUTLERY DISPENSER.....	447, 203, 210, 541-542
SUPPORT FOR PASTRY BAGS.....	264
TABLE CRUMBER.....	504
TABLE NUMBER.....	504
TABLE SING "RESERVED".....	504
TABLE-TIDY.....	506
TEA INFUSION MESH.....	527
TEA POT.....	525-527
TEA POT WITH FILTER.....	527
TEA&SUGAR BAGS DISPENSER. CUBIC.....	437
TEAR MOULD.....	261
TEMPLATES.....	420-421
TERRACOTA.....	371-373
THERMOMETER.....	143-145
THREE LEVELS STAND. CUBIC.....	434
TIN PLATES DISPLAY.....	489
TOASTER.....	298-302
TOMATOES SLICER.....	133
TONG.....	91, 93-97, 106, 478-481, 493, 517
TONG. BUTCHER'S.....	481
TONG. CAKE.....	480
TONG. UTILITY.....	94-95, 479-480
TONGS, SERVING.....	479-481
TOP LINE.....	28-29
TRAY.....	70-73, 76, 366, 368-371, 380-386, 378, 470, 522, 541-542
TRAY (FAST-FOOD).....	541
TRAY (GASTRONORM).....	70
TRAY (NON-STICK ALUMINIUM).....	70, 73
TRAY (PASTRY).....	72-73, 76, 389
TRAYS, FIBERGLASS.....	541
TRIANGLE CAKE MOULD.....	262
TROLLEY (ALUMINIUM SERVING).....	200
TROLLEY (DEFROST WITH RAIL).....	208
TROLLEY (DISASSEMBLED SERVING TROLLEY).....	202
TROLLEY (DISASSEMBLED WITH RAIL).....	205-207
TROLLEY (GUERIDON).....	446
TROLLEY (INOX SERVING).....	201-203

ITEM	PAGE
TROLLEY (PLASTIC).....	200, 214-215
TROLLEY (RAIL).....	204-209, 211-212
TROLLEY (STACKABLE).....	205-207
TROLLEY (WOODEN).....	444-447
TROLLEY FOR DISHWASER RACKS.....	212
TROLLEY FOR HEAVY LOADS.....	211
TROLLEY WITH WORKING TOP.....	211
TUBE.....	265-268
T-VERSION.....	178-183
UNIVERSAL STOPPER.....	520
VEGETABLE SCRAPER.....	140
VEGETABLE SIEVE.....	115
VERSATIL MACHINE.....	131
VERSATILE MANUAL PROCESSOR.....	135
VINYL RACK COVER.....	214
VIOLET COLLECTION.....	30-31, 101-109, 172
WAFFLES MAKER.....	297
WALL-MOUNTED COWKSCREW.....	521
WARMERS.....	324-325, 333-334, 409, 411
WATER PITCHER.....	530-531
WEDGER.....	130
WHISK.....	107, 245
WHITE WOOD SERVING TRAY.....	391
WINE BUCKETS.....	512-514
WINE COMPLEMENTS.....	520-521
WINE COOLER.....	513
WIRE SKIMMER.....	84
WOK (ST/STEEL).....	52
WOK BLAC SERIES.....	59
WOK MULTIMETAL.....	57
WOK STEEL.....	63
WOK STEEL PRO.....	61
WOOD HANDLE UTENSILS.....	100
WOODEN TABLE. CUBIC.....	437

ARTÍCULO	PÁGINA
AIGUISEUR ÉLECTRIQUE.....	322
ALU-PRO.....	37-39
ANTI ALLERGIQUE	30-31, 101-109
ANTIMICROBIEN	86-88
APLATISSEUR	119
APPAREILS ET DE MAINTIEN EN TEMP.....	324-325, 333-334, 409, 411
APPAREILS MANUELS DE TRANSFORMATION	
DES ALIMENTS	121-136
ARAIGNÉE	84
ARDOISES PRÉSENTATION.....	490-491
ARMOIRE CHAUD	341-342
ASSIETTES.....	364-369, 373, 374, 376-379, 387, 544
ASSIETTES, COULEUR.....	377
BAC GASTRONORME SANS BPA.....	168-169
BAIN-MARIE.....	24, 334, 340, 409, 411, 462
BALANCE.....	141-143
BAMBOU NATUREL & BOIS.....	492-493
BANDE À SILICONE.....	164
BAR KEEP®	523
BARRE INTERMÉDIAIRE	157, 414
BARRE PORTE-BONS	120
BASSINE	243
BASSINE PÂTISSIÈRE	244
BATTERIE À COULEURS.....	32, 404-409
BATTERIE DE CUISINE / PRÉSENTATION.....	416-421
BATTERIE IDEA.....	34-36
BLACK FIRST	60
BLACK PRO	58-59
BLACK SERIES.....	41, 75
BLENDERS.....	311-321
BOIS BLANVC, PLATEAU.....	391
BOÎTE À CONDIMENT	519
BOL.....	106, 364, 366, 369, 372, 381, 402, 467-469, 544
BOL POUR SNACKS	503
BOLS DE SERVICE ISOTHERMES À DOUBLE PAROI.....	106, 467-469
BOLS NID D'ABEILLES À PAROI INCLINÉE	467
BOUCHON À CHAMPAGNE	520
BOUCHON UNIVERSEL	520
BOUTEILLE DE BAR.....	523
BROCHETTE.....	505
BROSSE METALLIQUE	120
BRÛLER ÉMAILLÉ.....	65
BUFFET CUBIC. CHARIOT BUFFET	422-447
BUFFET CUBIC. CUBES ET TABLETTES.....	438
BUFFET CUBIC. MEUBLE PRÉSENTOIR.....	437, 440-442
CAFETIÈRE	525-526
CANNETTE ISOLANTE	528-529
CARAMÉLISER.....	251
CASSE-NOIX.....	481
CASSE-PATTES	481
CASSEROLE ALUMINIUM.....	39
CASSEROLE BOMBÉE	24, 39, 43, 243
CASSEROLE COOL • LINE.....	32
CASSEROLE FORME FRANÇAISE	23
CASSEROLE IDEA.....	35-36
CASSEROLE INOX-PRO	23-24
CASSEROLE VIOLET.....	30-31
CASSEROLLES DOSEUR.....	145

ARTÍCULO	PÁGINA
CAYENNE®	330-334
CAYENNE® RÉCHAUDS ET APPAREILS DE REMISE	
EN TEMPÉRATURE	326-333
CENDRIER.....	403, 506
CENTRIFUGEUSES.....	322
CERCLE.....	260
CHAFERS.....	456-461
CHAFERS INTRIGUE	456-457
CHAFERS NEW YORK®.....	458-459
CHAFERS, ACCESSOIRES POUR.....	457, 462-463
CHAFING DISH ECONOMIQUE	461
CHARIOT À CHARGES LOURDES	211
CHARIOT À DÉGIVRAGE.....	208
CHARIOT À GLAÇONS.....	215
CHARIOT À GLISSIÈRES	204-209, 211-212
CHARIOT À GLISSIÈRES, DÉMONTABLE.....	205-207
CHARIOT À GLISSIÈRES, EMBOÎTABLE	205-207
CHARIOT À PLASTIQUE	200, 214-215
CHARIOT AJUSTABLE.....	214
CHARIOT AVEC PLAN DE TREVALL	211
CHARIOT DE DÉBARASSAGE.....	200, 203
CHARIOT DE SERVICE DÉMONTABLE.....	202
CHARIOT DE SERVICE EN ALUMINIUM	200
CHARIOT DOUBLE POUR PLATEAUX FAST-FOOD	209
CHARIOT EN BOIS	444-447
CHARIOT GUERIDON	446
CHARIOT POUR PANIERS À VAISSELLE.....	212
CHARIOT TRANSPORT BAC GN.....	204-208
CHARIOTS DE SERVICE INOXYDABLE.....	201-203
CHINOIS À GAZE	113
CLIP D'IDENTIFICATION.....	178, 184-185, 189-190
COCKTAIL	516-517
COCOTTE	41
COCOTTE BLACK SERIES.....	41
COCOTTES FONTE ALUMINIUM.....	41
COLLECTIVITÉS	541-542, 544-545
CONTENEUR POUR SERVIETTES	507
COOL • LINE.....	32, 404-409
CORBILLE PAIN.....	495-496
CORBILLES POLYPROPYLÈNE	496-499
CORPS DE CHAUFFE POUR CHAFING DISH.....	463
COUPE À GLACE	239
COUPE EN CUBES.....	134
COUPE FRITES.....	127
COUPE FROMAGE	134
COUPE TOMATES	133
COUPE-OEUF.....	135
COUPE-ONIONS	129
COUPE-SALADE	128
COUP-FRUIT ET LÉGUMES.....	129
COUSCOUSSIER	25
COUTEAU.....	473, 475, 478
COUTEAU / ROULEAU (PIÈCE DE RECHNGE).....	135
COUTEAU À BEURRE.....	99-100
COUVER-ASSIETTES EN PLASTIQUE.....	509
COUVERCLE BATTERIE	23, 29, 30, 39
COUVERCLE GN.....	160, 162, 167, 169, 170, 172
COUVERCLE INOX-PRO.....	23
COUVERCLE POLINORM®	162, 167, 170, 172

ARTÍCULO	PÁGINA
COUVERCLE POUR COUPELLE DESSERT.....	544
COUVERCLE POUR PANIER.....	186
COUVERCLE VIOLET	30
COUVERCLES À ASSIETTE.....	509
COUVERCLES GN TRANSPARENTS	455
COUVERCLES POUR BOLS RONDS À DOUBLE PAROI	467
COUVRE-ASSIETTES INOX.....	509
CREMIÈRE	524-526
CRÊPIÈRE.....	297
CROCHET.....	115
CUILLÈRE	84-85, 90, 91, 107, 246, 388, 473-478
CUILLÈRE À COCKTAIL.....	517
CUILLÈRE À GLACE	90, 107, 238-239
CUILLÈRES À SERVIR.....	85, 107
CUISEUR À RIZ.....	296
CUIT-PÂTES.....	26
CUIT-VAPEUR INOX-PRO	26
DEMI-SPÉRIQUE	244
DISTRIBUER À JUS	459, 464
DISTRIBUTEUR À JUS. CUBIC.....	434, 443
DISTRIBUTEUR À LAIT.....	464
DISTRIBUTEUR À PRESSION.....	116-118
DISTRIBUTEUR CONTRÔLE DE LA PARTIE.....	254
DISTRIBUTEUR DE CÉRÉALES	464
DISTRIBUTEUR DES SAQUETTES THÉ & SUCRE. CUBIC	437
DISTRIBUTEUR SERVIETTES. CUBIC.....	437
DISTRIBUTEURS.....	254, 434, 443, 459, 464
DIVISEUR	130
DOSEUR À PRESSER	238-239
DOUILLE	265-268
ECAILEUR.....	120
ECUMOIRE.....	83-84, 91, 473-476
EGOUTTOIRS POUR BACS	
GASTRONORME.....	157, 158, 161, 167, 169, 171, 208
ELEGANCE	375
ENCASTRÉE	286, 327, 290, 458-459
ENTONNOIR	115, 253
ENTONNOIR DOSEUR.....	253
EPINGLE PORTE-TICKETS.....	505
ETAGÈRES	218-235
FAITOUT ALUMINIUM	38
FAITOUT COOL • LINE	32
FAITOUT IDEA.....	35-36
FAITOUT INOX-PRO	22
FAITOUT TOP LINE	29
FAITOUT VIOLET	30-31
FLAP IDENTIFICATION	177
FLAP-RACK®	174-191
FONTAIN À CHOCOLAT	340
FOUET	107, 245
FOUR À MICRO-ONDES	295
FOURCHETTE.....	85, 91, 120, 473-475
FOURS.....	296
FRITEUSE	292-293
FUEL POR CHAFING DISH	463
GABARITS	420-421
GANT À FOUR.....	146
GANTS.....	146
GASTRONORME POUR CHARIOT DÉGIVRAGE.....	208

ARTÍCULO	PÁGINA
GASTRONORM INOXYDABLE.....	156-162, 165
GASTRONORME (MELAMINE)	394-399
GASTRONORME (POLYCARBONATE).....	166-167
GASTRONORME (POLYPROPYLENE).....	170-171
GASTRONORME AVEC FOND THERMO-DIFFUSEUR.....	165
GASTRONORME VIOLET	172
GAUFFRIERS.....	297
GEL LUBRIFIANT SANITAIRE	136
GLACES.....	344-358, 238-240
GOUTTIÈRE.....	262
GRILL.....	59, 60
GRILL.....	304
GRILL PLAT AVEC POIGNÉES	75
GRILLE GN.....	74
GRILLE PÂTISSERIE	74, 254
HOUSSE JETABLES	211
HUILIÈRE.....	120
INFUSER À THÉ	527
INOX-PRO	20-26
KITS PRÉPARÉS DE ÉTEGÈRE	225-231
KITS. CUBIC.....	430-433
LAMPE CHAUFFANTE.....	336-338
LIDSAVER®.....	534-539
LOUCHE	82, 91, 106, 388, 473-477
MANDOLINES	136
MARMITE ALUMINIUM	38
MARMITE BUFFET	334
MARMITE COOL • LINE	32, 407
MARMITE INOX-PRO.....	22, 26
MARMITE TOP LINE	29
MARMITE TRAITEUR AVEC ROBINET.....	26
MARMITE TRAITEUR IDEA.....	35
MARMITES DE REMISE EN TEMPÉRATURE.....	326-333
MARMITES DE REMISE EN TEMPÉRATURE RÉTRO	328-329
MARQUEURS.....	483
MEDITERRANEAN.....	376
MELAMINE POUR PRÉSENTATION	360-403
MÉLAMINE SLIM	396-397
MÉLANGEURS	306-307
MÉLANGEURS DE COMPTOIR.....	306
MESURE À COCKTAIL	517
MINIATURE FONTE ÉMAILLÉE.....	486-487
MINIATURES MÉLAMINE	401-402
MINUTEUR DE CUISINE	143
MIRAGE®	326-327, 289-290
MIRAGE® 3D INDUCTION.....	326-327
MIRAGE® INDUCTION WARMER.....	289-290
MIRAMAR® BATTERIE DE CUISINE / PRÉSENTATION	416-421
MIRAMAR® GABARITS.....	420-421
MIXEURS.....	308-310
MOULE À CAKE.....	255, 262, 271
MOULE À FLAN.....	262, 271
MOULE À FLAN ÉVASSÉ.....	503
MOULE À NID	84
MOULE À OEUF.....	119
MOULE À PIZZA	77
MOULE COEUR.....	261
MOULE HEXAGONE.....	261
MOULE LARME.....	261

ARTICLE	PAGE
MOULE OVALE	257, 261
MOULES "FLEXIPAN"	274-281
MOULES À SILICONE 600 X 400	272-273
MOULES DE SILICONE	269-273
MOULES PÂTISSERIE.....	255-258, 260-262, 269-281
MOULIN À LÉGUMES.....	115
MOULINS À POIVRE	502
MOULINS À SEL.....	502
MULTIMETAL.....	43, 57
NEW YORK®	458-459
NUMÉRO DE TABLE.....	504
OICHET À EAU.....	530-531
OUVRE HŪITRES.....	134
OUVRE-BOÎTES.....	135
PALETTE	83, 91, 98, 107, 246, 473-478
PALETTE À FISH	83, 99
PALETTE FAST-FOOD	99
PANIER FERMÉES.....	180-183
PANIER OUVERTS.....	184-185
PANIER POUR ASSITTES.....	187-190, 196
PANIER POUR COUVERTS	186, 196
PANIER POUR PLATEAUX.....	190
PANIER POUR PLATEAUX ISOTHERMES.....	190
PANIER UNIVERSEL.....	186, 196
PANIER, METALIQUE	452
PANNEAU INFORMATION	482
PAPIER SILICONE.....	78
PARE-HALEINE MOBILES.....	462
PARE-HALEINE MOBILES EN ACRYLIQUE.....	462
PASSOIRE À COCKTAIL.....	517
PASSOIRE À POIGNÉES.....	114
PASSOIRE À QUEUE.....	112-114
PELLE À ENFOURNER.....	78
PELLE À FARINE.....	244
PELLE À FRITES	97
PELLE À GÂTEAU.....	100
PELLE À LEGUMES.....	140
PELLE PRÉSENTATION	390
PETIT PANIER POUR LES COUVERTS.....	186
PICHET	530-531
PICHET POLYCARBONATE	530-531
PICHET VIOLET	320
PIED POUR BRŪLEUR	65
PINCE	91, 93-97, 106, 478-481, 493, 517
PINCE À GÂTEAU	480
PINCE À VIANDE.....	481
PINCE BUFFET	94-95, 479-480
PINCE DE SERVICE	479-481
PINCEAU.....	248
PINCES POUR PRÉSENTATION.....	93
PIQUES SUPPORT PRÉSENTATION. CUBIC	435
PLANCHE À DÉCOUPER	137-140
PLANCHE À DÉCOUPER VIOLET.....	140
PLAQUE "DÉFENSE DE FUMER"	504
PLAQUE "RESERVÉ"	504
PLAQUE À PÂTISSERIE	72-73, 76, 389
PLAQUE À PIZZA.....	77
PLAQUE À RŪTIR	68-69, 75
PLAQUE ALUMINIUM ANTI-ADHESIF	70, 73

ARTICLE	PAGE
PLAQUE CHAUFFANTE	338, 240
PLAQUE GASTRONORME.....	70
PLAQUE INTERMÉDIAIRE INCLINÉE	453
PLAQUE RÉFRIGÉRANTE.....	471
PLAQUES INDUCTION	284-291
PLAT À PAELLA ACIER ÉMAILLÉ	64
PLAT À PAELLA ALUMINIUM.....	55
PLAT À PAELLA EN TŪLE ACIER.....	64
PLAT À PAELLA INOX-PRO	22
PLAT À PAELLA TOP LINE.....	29
PLAT OVALE.....	364, 367-368, 385-386, 470
PLATEAU.....	70-73, 76, 366, 368-371, 380-386, 378, 470, 522, 541-542
PLATEAU.....	522
PLATEAU DE SERVICE ANTI-DÉRRAPANT.....	505, 522
PLATEAU FAST-FOOD.....	541
PLATEAU FORME OVALE.....	470
PLATEAU ISHOTHERMIC.....	544
PLATEAU MARBRES NOIR.....	393
PLATEAU PRÉSENTATION	389
PLATEAU PRÉSENTATION. CUBIC.....	436
PLATEAU SELF-SERVICE ACIER INOX.....	541-542
PLATEAUX EN FIBRE DE VERRE.....	541
PLATEAUX INOX PRÉSENTATION	489
POCHES PÂTISSIÈRES.....	263-264
POÊLE "LYONNAISE"	63
POÊLE À BLINIS	56
POÊLE À CRÊPES.....	56, 59, 60, 63
POÊLE ACIER INOXYDABLE.....	50-52
POÊLE ALUMINIUM	54-56
POÊLE ALUMINIUM FONTÉ.....	58-59
POÊLE BLACK SERIES	58-59
POÊLE COOL • LINE.....	408
POÊLE HAUTE AVEC ANSES.....	64
POÊLE IDEA.....	52
POÊLE MULTIMETAL.....	57
POÊLE PUJADAS 1921	61
POÊLE VIOLET.....	56
POÊLES.....	48-63
POLUCARBONATE DOUILLE.....	268
PORTE-BROCHETTES.....	505
PORTE-CARTES.....	508
PORTE-MENU.....	508
POT À INFUSIONS	527
POT MESUREUR	145
POTEAU.....	482
PRÉSENTOIR.....	453
PRÉSENTOIR 3 NIVEAUX. CUBIC	434
PRÉSENTOIR BACS GASTRONORME.....	399
PRÉSENTOIR BOLS MÉLAMINE. CUBIC	439
PRÉSENTOIR DE TARTES.....	252
PRÉSENTOIR GN BAMBOU.....	449
PRÉSENTOIR GRANITE-ARDOISE	393
PRESS FRUITS.....	131
PRESSE CITRON.....	517
PROCESSEUR VERSATILE ET MANUEL.....	135
PROTECTRICE EN VINYLE.....	214
PUJADAS 1921. FONTE ULTRALÉGER INDUCTION.....	61
RACLETTE	99-100, 120, 249
RAMASSE-COUVERTS	542

ARTICLE	PAGE
RAMASSE-COUVERTS POUR CHARIOT SERVICE.....	203
RAMASSE-MIETTES.....	504
RAMEQUIN.....	371, 373, 400, 402
RÂPE.....	110-111
RECEPTALBE À DÉCHETS.....	506
RÉCHAUD.....	343
RÉCIPIENT À GLACE.....	240
RECTANGLE POUR PLAQUES INOX.....	72
REFRAÎCHISSEUR.....	513
REFRAÎCHISSEUR BOUTEILLES. CUBIC.....	437
REFRAÎCHISSEUR ISOTHERME.....	515
RINCE-CUILLÈRES ACIER INOX.....	240
ROBOT MULTIFUNCTION.....	306-307
ROULEAU.....	247-248
ROULETTE À PÂTES.....	247, 259
ROULETTE À PIZZA.....	99
RUBAN PÂTISSIER.....	261
SALADIER.....	471
SALAMANDRE.....	296
SAUCIÈRE.....	503
SAUPOUDREUSES.....	118
SAUTEUSE ALUMINIUM.....	39
SAUTEUSE INOX-PRO.....	24
SEAU À CHAMPAGNE.....	512-514
SEAU À CHAMPAGNE EN PLASTIQUE.....	512
SEAU À CHAMPAGNE, COMPLEMENTS.....	520-521
SEAU À GLAÇONS.....	515
SEAU AVEC BASE.....	514
SEAUX À VIN.....	512-514
SÉPARATEUR DE PORTIONS.....	249
SETS DE TABLE.....	500-501
SHAKER.....	516
SIGNATURE.....	195-197
SOLUTIONS DE DISTRIBUTION.....	534-539
SOUPIÈRE.....	471
SPATULE GÉANTE.....	120
SPOODLE®.....	86-88, 106
STATION POUR BUFFET À INDUCTION.....	465
STATIONS POUR BUFFET.....	339
STATIONS POUR BUFFET ARRONDIES.....	465
STONE.....	374
STOP GOUTTES.....	521
SUCRIER.....	525
SUPER PAN 3®.....	159-161
SUPER PAN® SUPER SHAPES.....	412-414
SUPPORT À PIQUES. CUBIC.....	435
SUPPORT DE TABLE POU SEAUX.....	513
SUPPORT DOUBLE PORTE-COUVERTS GN.....	542
SUPPORT NUMÉRO.....	504
SUPPORT POUR BACS GN.....	447, 210, 541
SUPPORT POUR BACS GN.....	163, 399
SUPPORT POUR CORNETS.....	239
SUPPORT POUR COUVERCLES GN.....	163
SUPPORT POUR ENTONNOIR OU CHINOIS.....	113
SUPPORT POUR GRANDS PLATEAUX.....	505
SUPPORT POUR PLANCHES À DÉCOUPER.....	163
SUPPORT POUR PLAQUES À PIZZA.....	78
SUPPORT POUR PLATEAU À FRUITS DE MER.....	505
SUPPORT POUR POCHE PÂTISSIER.....	264

ARTICLE	PAGE
SUPPORT RAMASSE-COUVERTS.....	447, 203, 210, 541-542
TABLE À DÉCOUPER.....	140
TABLE EN BOIS. CUBIC.....	437
TABLEAUX.....	483
TAMIS.....	252
TAPIS.....	147
TAPIS ANTIDÉRAPANT.....	522
TAPIS DE BAR.....	518
TASSE.....	388
TERRACOTA.....	371-373
THÉIÈRE.....	525-527
THÉIÈRE AVEC FILTRE.....	527
THERMOMÈTRE.....	143-145
TIRE-BOUCHONS.....	521
TIRE-BOUCHONS MUR.....	521
TOASTEUR.....	298-302
TOILE DE CUISSON.....	78
TOP LINE.....	28-29
TORCHE À CARAMÉLISER.....	251
TORCHON EN SILICONE.....	146
TRANCHES ET CUBES.....	125-126
TRANCHEUR ELÉCTRIQUE.....	307
TURBINE À GLACE.....	354-357
T-VERSION.....	178-183
USTENSILES MANCHE EN BOIS.....	100
USTENSILS DE SERVICE.....	473-481
VERRE.....	376, 545
VERSATIL MACHINE.....	131
VERSEUSE À POMPE.....	528-529
VIDE / COUPE POMMES.....	135
VIOLET COLLECTION.....	30-31, 101-109, 172
VITRINES À PÂTISSERIES.....	454-455
VITRINES PRÉSENTATION.....	454-455
WOK ACIER.....	63
WOK BLACK SERIES.....	59
WOK INOX.....	52
WOK MULTIMÉTAL.....	57
WOK STEEL PRO.....	61

ARTIKEL	SEITE
ABRÄUMWAGEN	200, 203
ABSPERRUNG	482
ADAPTERSCHIENE	157, 414
ALUMINIUMGUSSPFANNE	58-59
ALUMINIUMSAUTEUSE	39
ALUMINIUMTOPF	39
ALU-PRO	37-39
ANGEWINKELTE BIENENSTOCK-SCHÜSSELN	467
ANTI ALLERGIE	30-31, 101-109
ANTIHAFTBESCHICHTETES ALUMINIUMBLECH	70, 73
ANTIMIKROBIOTIKUM	86-88
ANTITROPFRING	521
ANZEIGETAFELN	490-491
APFELAUSSTECHER	135
ARBEITSFLÄCHEN-MIXER	306
ASCHENBECHER	403, 506
AUSFSTRICHMESSER	99-100
AUSGABELÖSUNGEN	534-539
AUSLAGEVETRINE	454-455
AUSSTECHFORMEN	247, 259
AUSSTELLER GASTRONORM	399
AUSTERÖFFNER	134
BACKWARENVITRINEN	454-455
BAR KEEP®	523
BARFLASCHE	523
BARMATTEN	518
BEHÄLTER FÜR SERVICEWAGEN	203
BESTECKKASTEN	542
BESTECKKASTEN	447, 203, 210, 541-542
BESTECKKÖRBCHEN	186
BESTECKSPÜLKORB	186, 196
BLACK FIRST	60
BLACK PRO	58-59
BLACK SERIES	41, 75
BLINISPFANNE	56
BRÄTER	68-69, 75
BRATPFANNE COOL • LINE	408
BRATPFANNE VIOLET	56
BRENNSTOFF FÜR CHAFING DISH	463
BROTKORB	495-496
BUFFET CUBIC. BUFFETWAGEN	422-447
BUFFET CUBIC. KÜBEL UND REGALE	438
BUFFET CUBIC. VITRINE	437, 440-442
BUFFETFLASCHENKÜHLER. CUBIC	437
BÜFFETSTATIONEN	339
BUFFETTISCHCHEN	437
BUFFETUTENSILIEN	473-481
BUFFETZANGE	94-95, 479-480
CAYENNE®	330-334
CAYENNE® SPEISENWÄRMER UND RETHERMALISIERER	326-333
CHAMPAGNERKÜHLER	520-521
COCKTAIL	516-517
COCKTAIL-LÖFFEL	517
COCKTAIL-SIEB	517
COOL • LINE	32, 404-409
COUSCOUSTOPF	25
CREPE-EISEN	297
CREPEPFANNE	56, 59, 60, 63
DAMPFGARER INOX-PRO	26

ARTIKEL	SEITE
DECKEL FRÜHSTÜCKSTASSE	544
DECKEL FÜR DOPPELWANDIGE SCHÜSSEL	467
DECKEL FÜR KOCHGESCHIRR	23, 29, 30, 39
DECKEL INOX-PRO	23
DECKEL POLINORM®	162, 167, 170, 172
DECKEL VIOLET	30
DECKELGN	160, 162, 167, 169, 170, 172
DIGITALE KÜCHENUHR	143
DOPPELTER FAST-FOOD TABLET-TROLLEY	209
DOPPELWANDIG ISOLIERTE SERVIERSCHÜSSELN	106, 467-469
DOSIERUNGSTRICHTER	253
DOSSIERKASSEROLLEN	145
DREIECKIGE FORM	262
DREIFUSSTÄNDER FÜR GASBRENNER	65
DRUCKDISPENSER	116-118
EDELSTAHL-TELLERHAUBEN	509
EIERSCHNEIDER	135
EIFORM	119
EIMER MIT FUSS	514
EINBAU	286, 327, 290, 458-459
EINSETZSCHABLONEN	420-421
EINSTELLBARER TELLERWAGEN	214
EINWEG-HÜLLEN AUS POLYÄTHYLEN	211
EISCREMEBECHER	239
EISCREMESCHALEN	240
EISCREMEWAFFELSTÄNDER	239
EISDIELE	344-358, 238-240
EISKÜBEL	515
EISMASCHINE	354-357
EISPORTIONIERER	238-239
EISPORTIONIERER	90, 107, 238-239
EISWAGEN	215
ELEGANCE	375
ELEKTRISCHER AUFSCHNITTMASCHINE	307
ELEKTRISCHER BRENNER	251
ELEKTRISCHER TOPF	334
ELEKTRISCHES ELEMENT FÜR CHAFING DISH	463
EMAILLIERTE GASPAELLAPFANNE	65
EMAILLIERTE PAELLAPFANNE AUS STAHL	64
FAST-FOOD- SCHAUFEL	99
FAST-FOOD-TABLETT	541
FISCHENTSCHUPPER	120
FISCHWENDER	83, 99
FLAP IDENTIFIKATION	177
FLAP-RACK®	174-191
FLEISCHSTAMPFER	119
FORMEN "FLEXIPLAN"	274-281
FRANZÖSISCHER KOCHTOPF INOX-PRO	23
FRITEUSE	292-293
FRITTENHEBER	97
FRITTIERSCHAUFEL	84
GABEL	85, 91, 120, 473-475
GASTRONORM BEHÄLTER OHNE BPA	168-169
GASTRONORM DIFFUSONSBODEN	165
GASTRONORM MELAMIN	394-399
GASTRONORM POLYKARBONAT	166-167
GASTRONORM POLYPROPYLEN	170-171
GASTRONORM ROSTFREI	156-162, 165
GASTRONORM VIOLET	172

ARTIKEL	SEITE
GASTRONORMTABLETT	70
GEBÄCKZANGE	480
GELOCHTE BÖDEN GASTRONORM	157, 158, 161, 167, 169, 171, 208
GEMÜSEHACKER	140
GEMÜSEHOBEL	136
GEMÜSESIEB	115
GEWELLTE BÜFFETSTATIONEN	465
GEWINKELTE ADAPTERPLATTE	453
GEWÜRZKISTE	519
GEWÜRZSTÄNDER	118
GLAS	376, 545
GLASFASERTABLETTS	541
GN BAMBUS BOX	449
GN TRANSPORTWAGEN	204-208
GRANIT-SCHIEFER PRÄSENTIERPLATTE	393
GRILL	304
GRILL	59, 60
GRILLKORB, SCHWARZER	452
GRILLPLATTE MIT GRIFFEN ALUMINIUM	75
HAKEN	115
HALBKUGELFORM	244
HALTER FÜR BESTECKKASTEN GN	542
HALTER FÜR GN DECKEL	163
HALTER FÜR GROSSE PLATTEN	505
HALTER FÜR SCHNEIDEBRETTER	163
HALTER FÜR SPRITZBEUTEL	264
HERDPLATTE	338, 240
HERZFORM	261
IDEA KASSEROLLE	35-36
IDEA KOCHBEDARF	34-36
IDEA STIELKASSEROLLE	35-36
IDEA TOPF	35
INDIVIDUELLE PLATZMATTEN	500-501
INDUKTIONSBÜFFETSTATION	465
INDUKTIONSKOCHFELDER	284-291
INDUSTRIELLER DOSENÖFFNER	135
INFORMATIONSTAFEL	482
INOX-PRO	20-26
ISOTHERMISCHER KÜHLER	515
ISOTHERMISCHES TABLETT	544
KAFFEEKANNE	525-526
KANNE	530-531
KANNE VIOLET	320
KARAFFE AUS POLYCARBONAT	530-531
KARTENHALTER	508
KÄSE DRAHTSCHNEIDER	134
KASSEROLLE	41
KASSEROLLE ALUMINIUM	38
KASSEROLLE BLACK SERIES	41
KASSEROLLE COOL • LINE	32
KASSEROLLE COOL • LINE	32
KASSEROLLE INOX-PRO	22
KASSEROLLE TOP LINE	29
KASSEROLLE VIOLET	30-31
KOCHGESCHIRR FARBIG	32, 404-409
KOCHTOPF INOX-PRO	23-24
KOLLEKTIVITÄT	541-542, 544-545
KOMPLETTE REGALSETS	225-231

ARTIKEL	SEITE
KONISCHE, TIEFE PLATTE	244
KONISCHER KOCHTOPF	24, 39, 43, 243
KORKENZIEHER	521
KORKENZIEHER WANDMONTAGE	521
KREIDEMARKER	483
KRÜMMELCHAUFEL	504
KUCHENBACKFORM	255, 262, 271
KÜCHENBRENNER	251
KÜCHENMASCHINE	306-307
KÜCHENMASCHINE	131
KÜHLPLATTE	471
LIDSAVER®	534-539
LÖFFEL	84-85, 90, 91, 107, 246, 388, 473-478
LÖFFEL	85, 107
LYONER PFANNE	63
MANUELLE KÜCHENMASCHINEN	121-136
MATTEN	147
MEDITERRANEAN	376
MEDIZINISCHES GLEITGEL	136
MEERESFRÜCHTEZANGE	481
MELAMIN MINIATUREN	401-402
MELAMIN PRÄSENTATION	360-403
MELAMIN PRÄSENTIERSCHALEN	439
MELMIN SLIM	396-397
MENÜHALTER	508
MESSBECHER	517
MESSBECHER	145
MESSER	473, 475, 478
MESSER/RAD (ERSATZTEIL)	135
MESSERSCHÄRFER	322
METALLBÜRSTE	120
MIKROWELLE	295
MILCHDISPENSER	464
MILCHKÄNNCHEN	524-526
MINIATUREN GUSSEISEN	486-487
MINIS AUS ALUMINIUM GUSS	41
MIRAGE®	326-327, 289-290
MIRAGE® 3D INDUCTION	326-327
MIRAGE® INDUCTION WARMER	289-290
MIRAMAR® EINSETZSCHABLONEN	420-421
MIRAMAR® PRÄSENTATIONS-KOCHGESCHIRR	416-421
MIXER	311-321
MIXERS	306-307
MOBILE ACRYL-ATEMSCHUTZPLATTEN	462
MOBILE ATEMSCHUTZPLATTEN	462
MULTIFUNKTIONSREIBE	135
MULTIMETAL	43, 57
NAMENSSCHILDER MIT CLIP	178, 184-185, 189-190
NATURBAMBUS & HOLZ	492-493
NEW YORK®	458-459
NOTIZLEISTE	120
NUDELSIEB	26
NUSSKNACKER	481
OBSTSCHNEIDER	129
ÖFEN	296
ÖKONOMISCHER CHAFING DISH	461
ÖLKANNE	120
OVALE FORM	257, 261

ARTIKEL	SEITE
OVALE PLATTE	470
OVALE PLATTE	364, 367-368, 385-386, 470
PAELLAPFANNE ALUMINIUM	55
PAELLAPFANNE INOX-PRO	22
PAELLAPFANNE TOP LINE	29
PATISSERIEFORMEN	255-258, 260-262, 269-281
PATISSERIEROST	74, 254
PATISSERIETABLETT	72-73, 76, 389
PFANNE ALUMINIUM	54-56
PFANNE BLACK SERIES	58-59
PFANNE EDELSTAHL	50-52
PFANNE IDEA	52
PFANNE MULTIMETAL	57
PFANNE PUCHADAS 1921	61
PFANNEN	48-63
PFANNENWENDER	83, 91, 98, 107, 246, 473-478
PFEFFERMÜHLE	502
PINSEL	248
PIZZAFORM	77
PIZZAMESSER	99
PIZZAPLATTE	77
PIZZAROST	78
PIZZASCHAUFEL	78
PLASTIK-SEKTKÜHLER	512
POLYPROPYLEN KÖRBE	496-499
POMMES FRITES-SCHNEIDER	127
PORTIONIERER	244
PORTIONSKONTROLLSPENDER	254
PRÄSENTATIONS-KOCHGESCHIRR	416-421
PRÄSENTATIONSSCHALE	389
PRÄSENTATIONSSTÄNDER	453
PRÄSENTATIONSTABLETT. CUBIC	436
PRÄSENTATIONSTABLETTES	489
PRÄSENTIERHALTER FÜR SPIESSCHEN, VIERECKIG	435
PRÄZISIONSPINZETTE	93
PRESSE	131
PUDDINGFORM	262, 271
PUJADAS 1921. GUSSEISEN ULTRALEICHT INDUKTION	61
PVC-BAND FÜR MOUSSE	261
RAHMEN FÜR BACKBLECHE	72
RECHAUDS	456-461
RECHAUDS INTRIGUE™	456-457
RECHAUDS NEW YORK®	458-459
RECHAUD-ZUBEHÖR	457, 462-463
RECHTECKIGE MARMOR-PRÄSENTATIONSPLATTE	393
REGALE	218-235
REIBE	110-111
REISKOCHER	296
REHERMALISIERER	326-333
RETRO REHERMALISIERER	328-329
RING	260
ROST GN	74
RÜHRBESEN	107, 245
RÜHRQUIRL	120
RÜHRSCHÜSSEL	243
RUTSCHFESTE MATTE	522
SAFTDISPENSER	459, 464
SAFTPRESSE	322
SAFTSPENDER. CUBIC	434, 443

ARTIKEL	SEITE
SALAMANDER	296
SALATSCHNEIDER	128
SALATSCHÜSSEL	471
SALZMÜHLE	502
SAUCIERE GEWELLTER RAND	503
SAUTEUSE INOX-PRO	24
SCHABER	99-100, 120, 249
SCHALE	106, 364, 366, 369, 372, 381, 402, 467-469, 544
SCHAUMLÖFFEL	83-84, 91, 473-476
SCHILD "RAUCHEN VERBOTEN"	504
SCHILD "RESERVIERT"	504
SCHNEIDEBRETT	137-140
SCHNEIDEBRETT VIOLET	140
SCHNEIDETISCH	140
SCHOKOLADENBRUNNEN	340
SCHÖPFLÖFFEL	82, 91, 106, 388, 473-477
SCHUTZHANDSCHUHE	146
SCHUTZHÜLLE VINYL	214
SECHSECKIGE FORM	261
SEKTKORKEN	520
SEKTKÜHLER	512-514
SELBSTBEDIENUNGSTABLETT EDELSTAHL	541-542
SERVICETABLETT ANTIRUTSCHBERSCHICHTUNG	505, 522
SERVIERPLATTE	390
SERVIERTABLETT	522
SERVIERWAGEN (ALUMINIUM)	200
SERVIERWAGEN (DEMONTIERBAR)	202
SERVIERWAGEN (INOX)	201-203
SERVIERZANGE	479-481
SERVETTENHALTER	507
SERVETTENSPENDER	437
SETS. CUBIC	430-433
SHAKER	516
SIEB	252
SIEB	112-114
SIEB	114
SIGNATURE	195-197
SILIKON-BAND	164
SILIKONFORMEN	269-273
SILIKONFORMEN 600 X 400	272-273
SILIKONPAPIER	78
SILIKONTUCH	146
SILIKONTUCH	78
SNACKSCHÄLCHEN	503
SOSSEN- UND SNACKHALTER	503
SOSSENSCHALE	371, 373, 400, 402
SPEISENWÄRMER IM VERGLEICH	324-325, 333-334, 409, 411
SPENDER	254, 434, 443, 459, 464
SPIESS	505
SPIESSCHENHALTER, VIERECKIG	435
SPIESSHALTER	505
SPITZSIEB	113
SPOODLE®	86-88, 106
SPRITZBEUTEL	263-264
SPÜLBECKEN FÜR PORTIONIERER	240
SPÜLKORB (GESCHLOSSENES SYSTEM)	184-185
SPÜLKORB (GROSSE TABLETTES)	190
SPÜLKORB (ISOTHERMISCHE TABLETTES)	190
SPÜLKORB (OFFENES SYSTEM)	180-183

ARTIKEL	SEITE
SPÜLKORB (TELLER).....	187-190, 196
SPÜLKORBDECKEL.....	186
STABMIXER.....	308-310
STAHLWOK.....	63
STÄNDER DREI EBENEN. CUBIC.....	434
STÄNDER FÜR GN BEHÄLTER.....	163, 399
STÄNDER FÜR MEERESFRÜCHTEPLATTE.....	505
STÄNDER FÜR SEKTKÜHLER.....	513
STÄNDER FÜR SPITZSIEB ODER TRICHTER.....	113
STIELKASSEROLLE VIOLET.....	30-31
STONE.....	374
SUPER PAN 3®.....	159-161
SUPER PAN® SUPER SHAPES.....	412-414
SUPPENSCHÜSSEL.....	471
TABLETT.....	70-73, 76, 366, 368-371, 380-386, 378, 470, 522, 541-542
TAFELN.....	483
TASSE.....	388
TEE- UND ZUCKERBEUTELHALTER.....	437
TEEKANNE.....	527
TEEKANNE.....	525-527
TEEKANNE MIT FILTER.....	527
TEESIEB.....	527
TEIGROLLE.....	247-248
TELLER.....	364-369, 373, 374, 376-379, 387, 544
TELLER, FARBE.....	377
TELLERHAUBEN.....	509
TELLERHAUBEN, KUNSTSTOFF.....	509
TELLERWÄRMER.....	343
TERRACOTA.....	371-373
THERMOMETER.....	143-145
THERMOSKANNE.....	528-529
THERMOSKANNE MIT DOSIERER.....	528-529
TIEFE, EMALLIERTE PFANNE MIT GRIFFEN.....	64
TISCHABFALLEIMER.....	506
TISCHNUMMERHALTER.....	504
TISCHNUMMERN.....	504
TISCHWÜRFELSCHNEIDER UND - HOBEL.....	125-126
TOASTER.....	298-302
TOMATENSCHNEIDER.....	133
TOP LINE.....	28-29
TOPF ALUMINIUM.....	38
TOPF COOL • LINE.....	32, 407
TOPF INOX-PRO.....	22, 26
TOPF MIT HAHN.....	26
TOPF TOP LINE.....	29
TOPFHANDSCHUH.....	146
TORTENHEBER.....	100
TORTENSCHNEIDER.....	249
TORTENSTÄNDER.....	252
TRÄNFENFORM.....	261
TRANSPARENTE GN PRÄSENTATIONDECKEL.....	455
TRANSPORTWAGE FÜR BESTECKBEHÄLTER.....	447, 210, 541
TRICHTER.....	115, 253
TROLLEY (GUERIDON).....	446
TÜLLE.....	265-268
TÜLLE POLYCARBONAT.....	268
T-VERSION.....	178-183
UNIVERSALSPÜLKORB.....	186, 196

ARTIKEL	SEITE
UNIVERSELLER KORKEN.....	520
UTENSILIEN MIT HOLZGRIFF.....	100
VALENZIANISCHE PAELLAPFANNE.....	64
VIOLET COLLECTION.....	30-31, 101-109, 172
VOGELNESTFORM.....	84
WAAGE.....	141-143
WAFFELEISEN.....	297
WAGEN (AUFTAUEN).....	208
WAGEN (EINSCHÜBE DEMONTIERBAR).....	205-207
WAGEN (EINSCHÜBE).....	204-209, 211-212
WAGEN (HOLZ).....	444-447
WAGEN (KUNSTSTOFF).....	200, 214-215
WAGEN (STAPELBAR).....	205-207
WAGEN AUFTAUEN.....	208
WAGEN FÜR SCHWERE LASTEN.....	211
WAGEN FÜR SPÜLKORBE.....	212
WAGEN MIT ARBEITSFLÄCHE.....	211
WÄRMELAMPEN.....	336-338
WARMHALTESCHRANK.....	341-342
WASSERBAD.....	24, 334, 340, 409, 411, 462
WASSERKRUG.....	530-531
WEDGER SCHNEIDER.....	130
WEIBE HOLZPRÄSENTATIONSTABLETT.....	391
WEINKÜHLER.....	512-514
WEINKÜHLER.....	513
WOK BLACK SERIES.....	59
WOK INOX.....	52
WOK MULTIMETAL.....	57
WOK STEEL PRO.....	61
WÜRFELSCHNEIDER.....	134
WURSTZANGE.....	481
ZANGE.....	91, 93-97, 106, 478-481, 493, 517
ZEREALIEN-DOPPELBEHÄLTER.....	464
ZETTELSPIESSER.....	505
ZITRONENPRESSE.....	517
ZUCKERDOSE.....	525
ZWIEBELSCHNEIDER.....	129

ARTIGO	PÁGINA
ABRE-LATAS INDUSTRIAL.....	135
ABRIDOR DE OSTRAS.....	134
AÇUCAREIRO.....	525
AFIADOR DE FACAS.....	322
ALMOTOLIA.....	120
ALU-PRO.....	37-39
ANEL ANTI-GOTEJAMENTO.....	521
ANTIALÉRGICO.....	30-31, 101-109
ANTIMICROBIANO.....	86-88
APANHADOR DE MIGALHAS.....	504
APRESENTADOR CUBAS GN.....	163, 399
APRESENTADOR TIGELAS MELAMINA. CUBIC.....	439
AQUECEDOR DE PRATOS.....	343
AQUECEDOR INDUÇÃO MIRAGE.....	289-290
AQUECEDORES.....	324-325, 333-334, 409, 411
ARANHA.....	84
ARDÓSIAS.....	483
ARDÓSIAS APRESENTAÇÃO.....	490-491
ARGOLA DE GUARDANAPO.....	507
ARGOLA DE GUARDANAPO. CUBIC.....	437
ARMÁRIO QUENTE.....	341-342
ARO.....	260
ASSADEIRA.....	68-69, 75
ASSADOR GRILL.....	59, 60
BALANÇA.....	141-143
BALDE CHAMPANHE.....	512-514
BALDE COM BASE.....	514
BALDE DE GELO DE PLÁSTICO.....	512
BALDE GELO.....	515
BAMBU NATURAL & MADEIRA.....	492-493
BANDEJA.....	70-73, 76, 366, 368-371, 380-386, 378, 470, 522, 541-542
BANDEJA ALUMÍNIO ANTI-ADERENTE.....	70, 73
BANDEJA APRESENTAÇÃO.....	389
BANDEJA EMPREGADO DE BAR.....	522
BANDEJA FAST-FOOD.....	541
BANDEJA GASTRONORM.....	70
BANDEJA ISOTÉRMICA.....	544
BANDEJA OVAL.....	470
BANDEJA PASTELARIA.....	72-73, 76, 389
BANDEJA PORTA-TALHERES.....	542
BANDEJA SELF-SERVICE AÇO INOX.....	541-542
BANDEJAS ANTIDESLIZANTES.....	505, 522
BANDEJAS FIBRA DE VIDRO.....	541
BANDEJAS. CUBIC.....	436
BANDOLINS.....	136
BANHO-MARIA.....	24, 334, 340, 409, 411, 462
BAR KEEP®.....	523
BARRA DE NOTAS.....	120
BASE PIZA.....	77
BATEDEIRAS DE COPO.....	311-321
BATEDOR.....	107, 245
BATEDORA DE MESA.....	306
BATERIA APRESENTAÇÃO.....	416-421
BATERIA COR.....	32, 404-409
BATERIA IDEA.....	34-36
BLACK FIRST.....	60
BLACK PRO.....	58-59
BLACK SERIES.....	41, 75
BOLSA PROTECTORA DE VINIL.....	214

ARTIGO	PÁGINA
BOLSAS REJEITÁVEIS POLIETILENO DISTRIBUIDOR.....	211
BOQUILHA.....	265-268
BOQUILHA POLICARBONATO.....	268
BRAÇOS TRITURADORES.....	308-310
BUFETE CUBIC. BALDES E ESTANTES.....	438
BUFETE CUBIC. CARRO BUFETE.....	422-447
BUFETE CUBIC. MÓVEL EXPOSITOR.....	437, 440-442
ÇAÇAROLA ALUMÍNIO.....	38
ÇAÇAROLA COOL • LINE.....	32
ÇAÇAROLA IDEA.....	35-36
ÇAÇAROLA INOX-PRO.....	22
ÇAÇAROLA TOP LINE.....	29
ÇAÇAROLA VIOLET.....	30-31
ÇAÇOILA ALUMÍNIO FUNDIÇÃO.....	41
ÇAÇOILA BLACK SERIES.....	41
CAFETEIRA.....	525-526
CAIXA CONDIMENTOS.....	519
CAIXA GN BAMBU.....	449
CALDEIRO.....	243
CARRO COM GUIAS.....	204-209, 211-212
CARRO COM GUIAS, DESMONTÁVEL.....	205-207
CARRO COM GUIAS, ENCASTRÁVEL.....	205-207
CARRO COM SUPERFÍCIE DE TRABALHO.....	211
CARRO DE MADEIRA.....	444-447
CARRO DE PLÁSTICO.....	200, 214-215
CARRO DE SERVIÇO DESMONTÁVEL.....	202
CARRO DE SERVIÇO EM ALUMÍNIO.....	200
CARRO DE SERVIÇO INOXIDÁVEL.....	201-203
CARRO DESCONGELAÇÃO.....	208
CARRO DESEMBARAÇO.....	200, 203
CARRO DUPLO PARA BANDEJAS FAST-FOOD.....	209
CARRO GASTRONORM DESCONGELAÇÃO.....	208
CARRO GELO.....	215
CARRO GUERIDON.....	446
CARRO PARA CARGAS PESADAS.....	211
CARRO PARA CESTOS.....	212
CARRO PARA PRATOS AJUSTÁVEL.....	214
CARRO PORTA-CUBAS GASTRONORM.....	204-208
CARRO PORTA-TALHERES.....	447, 210, 541
CAYENNE®.....	330-334
CESTA GRADEADA.....	452
CESTA PÃO.....	495-496
CESTINHO PARA TALHERES.....	186
CESTO DE PAPÉIS MESA.....	506
CESTO GRANDES BANDEJAS.....	190
CESTO PARA BANDEJAS ISOTÉRMICAS.....	190
CESTO PARA TALHERES.....	186, 196
CESTO UNIVERSAL.....	186, 196
CESTOS ABERTOS.....	180-183
CESTOS FECHADOS.....	184-185
CESTOS PARA PRATOS.....	187-190, 196
CESTOS POLIPROPILENO.....	496-499
CHAFING DISH.....	456-461
CHAFING DISHES ECONÓMICOS.....	461
CHAFING DISHES INTRIGUE.....	456-457
CHAFING DISHES NEW YORK, NEW YORK.....	458-459
CHAFING, ACESSÓRIOS.....	457, 462-463
CHALEIRA.....	525-527
CHALEIRA COM FILTRO.....	527

ARTIGO	PÁGINA
CHAMPANHEIRA	512-514
CHAMPANHEIRA, COMPLEMENTOS.....	520-521
CHÁVENA.....	388
CINZEIRO.....	403, 506
COADOR.....	112-114
COADOR CHINÊS.....	113
COADOR DE LÍQUIDOS	517
COADOR DE MASSA	26
COADOR ESFERA INFUSÕES.....	527
COCKTAIL	516-517
COLECTIVIDADES.....	541-542, 544-545
COLHER.....	84-85, 90, 91, 107, 246, 388, 473-478
COLHER BATEDEIRA	517
COLHER PARA UNTAR.....	99-100
COLHER SERVIÇO	85, 107
CONCHA.....	82, 91, 106, 388, 473-477
CONJUNTO DE TEMPEROS	118
CONJUNTOS DE ESTANTES COMPLETOS.....	225-231
CONJUNTOS. CUBIC.....	430-433
COOL • LINE.....	32, 404-409
COPO	376, 545
COQUETELEIRA.....	516
CORTADOR DE ALFACE	128
CORTADOR DE BATATAS FRITAS.....	127
CORTADOR DE CEBOLAS.....	129
CORTADOR DE OVOS.....	135
CORTADOR EM CUBOS.....	134
CORTADOR QUEIJOS	134
CORTADOR SECCIONADOR	130
CORTADOR TOMATES	133
CORTADOR/DESCAROÇADOR MAÇÃS	135
CORTADORA DE FIAMBRES ELÉCTRICA.....	307
CORTADORA DE FRUTAS E VERDURAS.....	129
CORTADOR-FIADOR.....	125-126
CORTA-MASSAS	247, 259
CRIVO	252
CUBA GASTRONORM SEM BPA	168-169
CUBAS GELATARIA.....	240
CUSCUZEIRA.....	25
DISTRIBUIDOR COM CONTROLO DE PORÇÕES	254
DISTRIBUIDOR DE CEREAIS.....	464
DISTRIBUIDOR DE SUMOS	459, 464
DISTRIBUIDOR LEITE.....	464
DISTRIBUIDOR SACOS CHÁ E AÇÚCAR. CUBIC.....	437
DISTRIBUIDOR SOB PRESSÃO	116-118
DISTRIBUIDOR SUMOS. CUBIC.....	434, 443
DISTRIBUIDORES.....	254, 434, 443, 459, 464
DOSEADOR LICOR.....	517
ELEGANCE	375
ELEMENTO ELÉCTRICO CHAFING DISH.....	463
ESCAMADOR.....	120
ESCORREDOR.....	114
ESCOVA METÁLICA.....	120
ESCUMADEIRA	83-84, 91, 473-476
ESMAGA-CARNES.....	119
ESPÁTULA	83, 91, 98, 107, 246, 473-478
ESPETO PARA NOTAS.....	505
ESPETOS. SUPORTE APRESENTAÇÃO. CUBIC.....	435

ARTIGO	PÁGINA
ESPREMEDOR	131
ESPREME-LIMÕES.....	517
ESTAÇÃO BUFFET	465
ESTAÇÃO BUFFET PARA FOGÃO INDUÇÃO.....	465
ESTAÇÃO BUFFET TRINTANCHE	339
ESTANTES	218-235
EXPOSITOR DE TORTAS.....	252
EXPOSITOR DOÇARIA	454-455
EXPOSITOR GASTRONORM.....	399
EXPOSITOR TRÊS NÍVEIS. CUBIC.....	434
EXPOSITORES	453
FACA.....	473, 475, 478
FERVEDOR DE ARROZ.....	296
FITA DE SELAGEM SILICONE.....	164
FITA PVC PARA MOUSSE	261
FLAP IDENTIFICAÇÃO.....	177
FLAP-RACK®	174-191
FORMA DE PUDIM.....	262, 271
FORNOS.....	296
FRITADEIRA.....	292-293
FUELÓLEO PARA CHAFING DISH	463
FUNDOS PERFURADOS	
GASTRONORM.....	157, 158, 161, 167, 169, 171, 208
FUNIL.....	115, 253
FUNIL DOSEADOR.....	253
GANCHO.....	115
GARFO	85, 91, 120, 473-475
GARRAFA BAR	523
GASTRONORM FUNDO DIFUSOR	165
GASTRONORM INOXIDÁVEL	156-162, 165
GASTRONORM MELAMINA.....	394-399
GASTRONORM POLICARBONATO.....	166-167
GASTRONORM POLIPROPILENO.....	170-171
GASTRONORM VIOLET	172
GEL LUBRIFICANTE SANITÁRIO	136
GELATARIA	344-358, 238-240
GRAMPO DE IDENTIFICAÇÃO.....	178, 184-185, 189-190
GRELHA PLANA COM PEGAS ALUMÍNIO.....	75
GRELHADOR	304
GRELHAS GN	74
GRELHAS PASTELARIA	74, 254
INDUÇÃO 3-D MIRAGE.....	326-327
INOX-PRO	20-26
INSERTOS.....	286, 327, 290, 458-459
JARRA	530-531
JARRA ÁGUA	530-531
JARRA DE MEDIÇÃO	145
JARRA PARA INFUSÕES.....	527
JARRA POLICARBONATO	530-531
JARRA TERMO	528-529
JARRA VIOLET.....	320
LÂMINA/ROLO SOBRESSALENTE	135
LÂMPADA MANTENEDORA	336-338
LAVA-RACIONADOR AÇO INOX.....	240
LEITEIRA.....	524-526
LIDSAVER®.....	534-539
LIQUIDIFICADORES.....	322
LUVA SEM DEDOS	146

ARTIGO	PÁGINA
LUVAS PROTECÇÃO	146
MAÇARICO COZINHA	251
MANGAS DE PASTÉIS	263-264
MANTA REFRIGERADORA	513
MÁQUINA DE CREPES	297
MÁQUINA DE GELADOS	354-357
MÁQUINAS DE GOFRES	297
MARCADOR DE TORTAS	249
MARCADORES GIZ	483
MEDITERRANEAN	376
MELAMINA APRESENTAÇÃO	360-403
MELAMINA SLIM	396-397
MESA DE CORTE	140
MESINHA BUFFET. CUBIC	437
MICRO-ONDAS	295
MINIATURAS ALUMÍNIO FUNDIÇÃO	41
MINIATURAS FERRO FUNDIDO	486-487
MINIATURAS MELAMINA	401-402
MIRAGE®	326-327, 289-290
MIRAMAR® BATERIA APRESENTAÇÃO	416-421
MIRAMAR® MODELOS	420-421
MODELOS	420-421
MOINHO PIMENTA	502
MOINHO SAL	502
MOLDE CAKE	255, 262, 271
MOLDE FORMA CORAÇÃO	261
MOLDE FORMA LÁGRIMA	261
MOLDE HEXAGONAL	261
MOLDE MEIA CANA	262
MOLDE NINHO	84
MOLDE OVAL	257, 261
MOLDE OVO	119
MOLDE PARA PIZA	77
MOLDE SEMIESFÉRICO	244
MOLDES "FLEXIPAN"	274-281
MOLDES DE SILICONE	269-273
MOLDES PASTELARIA	255-258, 260-262, 269-281
MOLDES SILICONE 600 X 400	272-273
MOLHEIRA	503
MOLHEIRA BORDA ONDULADA	503
MULTIMETAL	43, 57
NEW YORK®	458-459
NÚMERO MESA	504
PÁ	244
PÁ APRESENTAÇÃO	390
PÁ BATATAS FRITAS	97
PÁ FAST-FOOD	99
PÁ PASTÉIS	100
PÁ PEIXE	83, 99
PÁ PIZA	78
PAINEL INFORMAÇÃO	482
PANELA A VAPOR INOX-PRO	26
PANELA ALUMÍNIO	38
PANELA COM TORNEIRA	26
PANELA COOL • LINE	32, 407
PANELA DE PAELHA ESMALTADA GÁS	65
PANELA ELÉCTRICA	334
PANELA IDEA	35
PANELA INOX-PRO	22, 26

ARTIGO	PÁGINA
PANELA TOP LINE	29
PANO SILICONE	146
PAPEL SILICONIZADO	78
PASSADOR DE PURÉS	115
PERFIS DIVISÓRIOS	157, 414
PICO/ESPETO	505
PIÇA	91, 93-97, 106, 478-481, 493, 517
PIÇA BUFETE	94-95, 479-480
PIÇA CHARCUTARIA	481
PIÇA PARA MARISCO	481
PIÇA PASTELARIA	480
PIÇA SERVIÇO	479-481
PIÇAS PARA EMPRATAR	93
PINCEL	248
PLACA "RESERVADO"	504
PLACA ADAPTADORA ANGULAR	453
PLACA DE CORTE	137-140
PLACA DE CORTE VIOLET	140
PLACA PROIBIDO FUMAR	504
PLACA QUENTE	338, 240
PLACA REFRIGERADORA	471
PLACAS INDUÇÃO	284-291
PORCIONADOR APERTÁVEL	238-239
PORTA-CARTÕES	508
PORTA-ESPETOS	505
PORTA-MENUS	508
PORTA-SALGADOS/PORTA-MOLHOS	503
PORTA-TALHERES	447, 203, 210, 541-542
POSTE SEPARAÇÃO	482
PRATOS	364-369, 373, 374, 376-379, 387, 544
PRATOS COLORIDOS	377
PROCESSADOR DE ALIMENTOS	306-307
PROCESSADOR VERSÁTIL MANUAL	135
PROCESSADORES MANUAIS DE ALIMENTOS	121-136
PROTETOR ACRÍLICO ANTI-HÁLITO	462
PROTETOR ANTI-HÁLITO	462
PUXADAS 1921. FERRO DE FUNDIÇÃO ULTRALEVE INDUÇÃO	61
QUADROS PARA BANDEJAS	72
QUEBRA-NOZES	481
QUEIMADOR ELÉCTRICO	251
RACIONADOR DE GELADO	90, 107, 238-239
RALADOR	110-111
RASPADOR	99-100, 120, 249
RECIPIENTE PARA MOLHOS	371, 373, 400, 402
RECOLHE-VERDURAS	140
REFRIGERADOR GARRAFAS BUFFET. CUBIC	437
REFRIGERADOR ISOTÉRMICO	515
RELÓGIO DE COZINHA DIGITAL	143
REMO	120
RETERMALIZADOR	326-333
RETERMALIZADOR RETRO	328-329
RETERMALIZADORES/AQUECEDORES ALIMENTOS	326-333
ROLETA CORTA-PIZAS	99
ROLO	247-248
SACA-ROLHAS	521
SACA-ROLHAS DE PAREDE	521
SALADEIRA ACRÍLICA	471
SALAMANDRA	296
SAUTEX ALUMÍNIO	39

ARTIGO	PÁGINA
SAUTEX INOX-PRO.....	24
SERTÃ "LIONESA".....	63
SERTÃ AÇO ESMALTADO.....	64
SERTÃ AÇO INOXIDÁVEL.....	50-52
SERTÃ ALUMÍNIO.....	55
SERTÃ ALUMÍNIO.....	54-56
SERTÃ ALUMÍNIO FUNDIÇÃO.....	58-59
SERTÃ BLACK SERIES.....	58-59
SERTÃ CREPES.....	56, 59, 60, 63
SERTÃ FUNDA ESMALTADA COM PEGAS.....	64
SERTÃ IDEA.....	52
SERTÃ INOX-PRO.....	22
SERTÃ MULTIMETAL.....	57
SERTÃ PARA BLINIS.....	56
SERTÃ PUXADAS 1921.....	61
SERTÃ TOP LINE.....	29
SERTÃ VALENCIANA.....	64
SERTÃS.....	48-63
SERTÃS COOL • LINE.....	408
SERTÃS VIOLET.....	56
SIGNATURE.....	195-197
SOLUÇÕES DE DISPENSA.....	534-539
SPOODLE®.....	86-88, 106
STONE.....	374
SUPER PAN 3®.....	159-161
SUPER PAN® SUPER SHAPES.....	412-414
SUPORTE APRESENTAÇÃO ARDÓSIA-MÁRMORE.....	393
SUPORTE APRESENTAÇÃO MADEIRA BRANCA.....	391
SUPORTE CARTUCHO.....	239
SUPORTE MÁRMORE APRESENTAÇÃO.....	393
SUPORTE MESA BANDEJA MARISCO.....	505
SUPORTE PARA BALDE CHAMPANHE.....	513
SUPORTE PARA BANDEJAS DE TAMANHO GRANDE.....	505
SUPORTE PARA BANDEJAS PORTA-TALHERES GN.....	542
SUPORTE PARA ESPETOS. CUBIC.....	435
SUPORTE PARA MANGAS DE PASTÉIS.....	264
SUPORTE PARA NÚMEROS.....	504
SUPORTE PARA PASSADOR CHINÊS OU FUNIL.....	113
SUPORTE PARA PIZAS.....	78
SUPORTE PARA PLACAS DE CORTE.....	163
SUPORTE TAMPAS GN.....	163
TABULEIRO DE TALHERES PARA CARRO SERVIÇO.....	203
TAÇA GELADO.....	239
TACHO ALUMÍNIO.....	39
TACHO BOLEADO.....	24, 39, 43, 243
TACHO COOL • LINE.....	32
TACHO IDEA.....	35-36
TACHO INOX-PRO.....	23-24
TACHO TIPO FRANCÊS.....	23
TACHO VIOLET.....	30-31
TACHOS DE MEDIÇÃO.....	145
TAMPA BATERIA.....	23, 29, 30, 39
TAMPA CHAMPANHE.....	520
TAMPA CHÁVENA PEQUENO-ALMOÇO.....	544
TAMPA GN.....	160, 162, 167, 169, 170, 172
TAMPA INOX PARA PRATOS.....	509
TAMPA INOX-PRO.....	23
TAMPA PARA CESTO.....	186
TAMPA PARA TIGELA PAREDE DUPLA.....	467

ARTIGO	PÁGINA
TAMPA POLINORM®.....	162, 167, 170, 172
TAMPA PRATOS.....	509
TAMPA PRATOS PLÁSTICO.....	509
TAMPA UNIVERSAL.....	520
TAMPA VIOLET.....	30
TAMPAS GN TRANSPARENTES.....	455
TAPETE DE BAR PAR ESCORRER TAÇAS.....	518
TAPETE DE SILICONE.....	78
TAPETES.....	147
TERMO COM DOSEADOR.....	528-529
TERMÓMETRO.....	143-145
TERRACOTA.....	371-373
TERRINA.....	471
TIGELA.....	106, 364, 366, 369, 372, 381, 402, 467-469, 544
TIGELA ESTRIADA INCLINADA.....	467
TIGELA PAREDE DUPLA.....	106, 467-469
TOALHA DE MESA ANTIDESLIZANTE PARA BANDEJA.....	522
TOALHAS DE MESA INDIVIDUAIS.....	500-501
TOP LINE.....	28-29
TORRADEIRA.....	298-302
TRAVESSA FONDUE CHOCOLATE.....	340
TRAVESSA FUNDA CÓNICA.....	244
TRAVESSA OVAL.....	364, 367-368, 385-386, 470
TRIPÉ PANELA DE PAELHA.....	65
T-VERSION.....	178-183
UTENSÍLIOS CABO MADEIRA.....	100
UTENSÍLIOS DE SERVIÇO.....	473-481
VERSATIL MACHINE.....	131
VIOLET COLLECTION.....	30-31, 101-109, 172
VITRINAS APRESENTAÇÃO.....	454-455
WOK AÇO.....	63
WOK BLACK SERIES.....	59
WOK INOX.....	52
WOK MULTIMETAL.....	57
WOK STEEL PRO.....	61

Артикул	Страница
BAR KEEP®	523
BLACK FIRST	60
BLACK PRO	58-59
CAYENNE®	330-334
COOL • LINE	32, 404-409
ELEGANCE	375
GASTRONORM МЕЛАМИНОВАЯ ПОСУДА	394-399
LIDSAVER®	534-539
MEDITERRANEAN	376
MIRAGE®	326-327, 289-290
MIRAMAR® НАБОР КАСТРЮЛЬ ПРЕЗЕНТАЦИОННЫЙ	416-421
MIRAMAR® ТРАФАРЕТЫ	420-421
NEW YORK®	458-459
SIGNATURE	195-197
SPOODLE®	86-88, 106
STONE	374
SUPER PAN 3®	159-161
SUPER PAN® SUPER SHAPES	412-414
TERRACOTA	371-373
T-VERSION	178-183
АКРИЛОВЫЙ ПРОТЕКТОР ПРОТИВОДЫХАТЕЛЬНЫЙ	462
АЛЮМИНИЕВАЯ ЛИТАЯ МИНИ-КАСТРЮЛЯ	41
АЛЮМИНИЕВЫЙ ПОДНОС С ПРОТИВОПРИГАРНЫМ ПOKPЫТИЕМ	70, 73
БАРНОЕ СИТО СТРЭЙНЕР	517
БАРНЫЙ КОВРИК ДЛЯ СУШКИ БОКАЛОВ	518
БАРЬЕРНЫЕ СТОЛБИКИ	482
БЛЕНДЕРЫ	322
БЛЕНДЕРЫ КУВШИННЫЕ	311-321
БЛЕНДЕРЫ ПОГРУЖНЫЕ	308-310
БЛИННИЦА	297
БРУС ДЛЯ ЗАМЕТОК	120
БУТЫЛКА ДЛЯ БАРА	523
БУФЕТ	465
БУФЕТ "CUBIC" ТЕЛЕЖКА БУФЕТНАЯ	422-447
БУФЕТ CUBIC ВИТРИНА	437, 440-442
БУФЕТ CUBIC КУБЫ И ПОЛКИ	438
БУФЕТ ДЛЯ ИНДУКЦИОННОЙ КУХНИ	465
БУФЕТ ДЛЯ НАРЕЗКИ	339
ВЕДРО ДЛЯ ЛЬДА	515
ВЕДРО ДЛЯ МУСОРА НАСТОЛЬНОЕ	506
ВЕДРО ДЛЯ ШАМПАНСКОГО	512-514
ВЕДРО С ОСНОВОЙ	514
ВЕНЧИК	107, 245
ВЕСЛО	120
ВЕСЫ	141-143
ВИЛКА	85, 91, 120, 473-475
ВИТРИНА GASTRONORM	399
ВИТРИНА ДЛЯ ВЫПЕЧКИ	454-455
ВИТРИНА ТРЕХ-УРОВНЕВАЯ CUBIC	434
ВИТРИНЫ	453
ВОРОНКА	115, 253
ВОРОНКА С ДОЗАТОРОМ	253
ВСТАВКИ	286, 327, 290, 458-459
ГАЗОВАЯ ГОРЕЛКА	251
ГАСТРОЕМКОСТЬ GASTRONORM, БЕЗ ДФП	168-169
ГАСТРОЕМКОСТЬ VIOLET	172
ГАСТРОЕМКОСТЬ ИЗ НЕРЖ. СТАЛИ	240

Артикул	Страница
ГЕЛЬ СМАЗОЧНЫЙ САНИТАРНЫЙ	136
ГОРЮЧЕЕ ДЛЯ ЧАФИНДИША	463
ГОРЯЧАЯ ПЛИТА	338, 240
ГОФРЕНИЦА	297
ГРИЛЬ	304
ГРИЛЬ САЛАМАНДРА	296
ДЕЛИТЕЛЬ ДЛЯ ТОРТА	249
ДЕРЖАТЕЛИ ДЛЯ КОНДИТЕРСКИХ МЕШКОВ	264
ДЕРЖАТЕЛЬ ДЛЯ ВИЗИТОК	508
ДЕРЖАТЕЛЬ ДЛЯ КИТАЙСКОГО ДУРШЛАГА ИЛИ ВОРОНКИ	113
ДЕРЖАТЕЛЬ ДЛЯ КОНУСНОГО СТАКАНЧИКА	239
ДЕРЖАТЕЛЬ ДЛЯ МЕНЮ	508
ДЕРЖАТЕЛЬ ДЛЯ ПАЛОЧЕК	505
ДЕРЖАТЕЛЬ ДЛЯ ПОДНОСОВ С ПРИБОРАМИ GN	542
ДЕРЖАТЕЛЬ ДЛЯ РАЗДЕЛОЧНЫХ ДОСОК	163
ДЕРЖАТЕЛЬ НОМЕРКОВ	504
ДЖИГЕР	517
ДИСПЕНСЕР ДЛЯ ЗЛАКОВЫХ	464
ДИСПЕНСЕР ДЛЯ МЕШОЧКОВ ЧАЯ И САХАРА CUBIC	437
ДИСПЕНСЕР ДЛЯ МОЛОКА	464
ДИСПЕНСЕР ДЛЯ СОКОВ	459, 464
ДИСПЕНСЕР ПОД ДАВЛЕНИЕМ	116-118
ДИСПЕНСЕР С КОНТРОЛЕМ ПОРЦИЙ	254
ДИСПЕНСЕР С ОДНОРАЗОВЫМИ ПОЛИЭТИЛЕНОВЫМИ ЧЕХЛАМИ	211
ДИСПЕНСЕРЫ	254, 434, 443, 459, 464
ДОСКА ДЛЯ НАРЕЗКИ VIOLET	140
ДОСКА РАЗДЕЛОЧНАЯ	137-140
ДОСКИ	483
ДУРШЛАГ	112-114
ДУРШЛАГ	114
ДУРШЛАГ ДЛЯ МАКАРОННЫХ ИЗДЕЛИЙ	26
ДУХОВЫЕ ШКАФЫ	296
ЕМКОСТЬ ДЛЯ ПРЕЗЕНТАЦИИ МЕЛАМИНОВЫХ ПИАЛ CUBIC	439
ЖАРОВНЯ-ГРИЛЬ	59, 60
ЗАЩИТНЫЕ ПЕРЧАТКИ	146
ЗАЩИТНЫЙ ВИНИЛОВЫЙ ЧЕХОЛ	214
ИДЕНТИФИКАЦИОННЫЙ ЗНАЧЕК	177
ИДЕНТИФИКАЦИОННЫЙ КЛИП	178, 184-185, 189-190
ИЗОТЕРМИЧЕСКИЙ ОХЛАДИТЕЛЬ	515
ИНВЕНТАРЬ С ДЕРЕВЯННЫМИ РУЧКАМИ	100
ИНДИВИДУАЛЬНЫЕ КОВРИКИ ДЛЯ СЕРВИРОВКИ	500-501
ИНДУКЦИОННАЯ ПЛИТА	284-291
ИНДУКЦИОННАЯ ПЛИТА 3-D MIRAGE	326-327
ИНДУКЦИОННЫЙ НАГРЕВАТЕЛЬ MIRAGE	289-290
ИНФОРМАЦИОННОЕ ТАБЛО	482
КАСТРЮЛЬКА	82, 91, 106, 388, 473-477
КАСТРЮЛЯ COOL • LINE	32
КАСТРЮЛЯ IDEA	35-36
КАСТРЮЛЯ INOX-PRO	22
КАСТРЮЛЯ TOP LINE	29
КАСТРЮЛЯ VIOLET	30-31
КАСТРЮЛЯ АЛЮМИНИЕВАЯ	38
КАСТРЮЛЯ ВОК PUJADAS 1921	61
КАСТРЮЛЯ ВОК MULTIMETAL	57
КАСТРЮЛЯ ВОК ИЗ НЕРЖАВЕЮЩЕЙ СТАЛИ	52
КАСТРЮЛЯ ВОК ИЗ СТАЛИ	63
КАСТРЮЛЯ ВОК СЕРИИ BLACK	59

Артикул	Страница
КАСТРЮЛЯ ГЛУБОКАЯ	22, 26
КАСТРЮЛЯ ГЛУБОКАЯ COOL • LINE	32, 407
КАСТРЮЛЯ ГЛУБОКАЯ IDEA	35
КАСТРЮЛЯ ГЛУБОКАЯ TOP LINE	29
КАСТРЮЛЯ ГЛУБОКАЯ АЛЮМИНИЕВАЯ	38
КАСТРЮЛЯ ДЛЯ КУС-КУСА	25
КАСТРЮЛЯ ИЗ ЛИТОГО АЛЮМИНИЯ	41
КАСТРЮЛЯ ПАРОВАРКА ИЗ НЕРЖАВЕЮЩЕЙ СТАЛИ	26
КАСТРЮЛЯ ПАЗЛЯ INOX-PRO	22
КАСТРЮЛЯ ПАЗЛЯ TOP LINE	29
КАСТРЮЛЯ ПАЗЛЯ АЛЮМИНИЕВАЯ	55
КАСТРЮЛЯ ПАЗЛЯ ВАЛЕНСИЙСКАЯ	64
КАСТРЮЛЯ ПАЗЛЯ ИЗ СТАЛИ, ЭМАЛИРОВАННАЯ	64
КАСТРЮЛЯ ПАЗЛЯ, ЭМАЛИРОВАННАЯ, ДЛЯ ГАЗОВОЙ ПЛИТЫ	65
КАСТРЮЛЯ С КРАНОМ	26
КАСТРЮЛЯ СЕРИИ BLACK	41
КАСТРЮЛЯ-СОУСНИК ИЗ НЕРЖАВЕЮЩЕЙ СТАЛИ	23-24
КАСТРЮЛЯ-СОУСНИК КОНИЧЕСКИЙ	24, 39, 43, 243
КАСТРЮЛЯ-СОУСНИК ФРАНЦУЗСКОГО ТИПА	23
КИСТОЧКА	248
КИТАЙСКИЙ ДУРШЛАГ	113
КОВРИКИ	147
КОКТЕЙЛЬ	516-517
КОЛЛЕКЦИЯ VIOLET	30-31, 101-109, 172
КОЛЬЦО	260
КОЛЬЦО ДЛЯ БУТЫЛКИ ВИНА	521
КОНТЕЙНЕР ДЛЯ ПРИБОРОВ	447, 203, 210, 541-542
КОРЗИНА ДЛЯ БОЛЬШИХ ПОДНОСОВ	190
КОРЗИНА ДЛЯ ИЗОТЕРМИЧЕСКИХ ПОДНОСОВ	190
КОРЗИНКА ДЛЯ ПРИБОРОВ	186, 196
КОРЗИНКА ДЛЯ ПРИБОРОВ	186
КОРЗИНКА СЕТЧАТАЯ	452
КОРЗИНКА ХЛЕБНАЯ	495-496
КОРЗИНЫ ДЛЯ ТАРЕЛОК	187-190, 196
КОРЗИНЫ ЗАКРЫТЫЕ	184-185
КОРЗИНЫ ОТКРЫТЫЕ	180-183
КОРЗИНЫ ПОЛИПРОПИЛЕНОВЫЕ	496-499
КОРОБКА GN БАМБУКОВАЯ	449
КОРОБКА ДЛЯ ПРИПРАВ	519
КОТЕЛ	243
КОФЕЦНИЦА	525-526
КРЫШКА GN	160, 162, 167, 169, 170, 172
КРЫШКА POLINORM®	162, 167, 170, 172
КРЫШКА VIOLET	30
КРЫШКА ДЛЯ КАСТРЮЛЬ	23, 29, 30, 39
КРЫШКА ДЛЯ КОРЗИНЫ	186
КРЫШКА ДЛЯ ПИАЛЫ С ДВОЙНЫМИ СТЕНКАМИ	467
КРЫШКА ДЛЯ ТАРЕЛОК	509
КРЫШКА ИЗ НЕРЖАВЕЮЩЕЙ СТАЛИ	23
КРЫШКА НА ЧАШКУ ДЛЯ ЗАВТРАКА	544
КРЮЧОК	115
КУВШИН	530-531
КУВШИН VIOLET	320
КУВШИН ДЛЯ ВОДЫ	530-531
КУВШИН ИЗ ПОЛИКАРБОНАТА	530-531
КУВШИН-ТЕРМОС	528-529
КУХОННЫЙ ПРОЦЕССОР	306-307
ЛАМПА ПОДОГРЕВА	336-338

Артикул	Страница
ЛЕЙКА ДЛЯ МАСЛА	120
ЛЕНТА КОНДИТЕРСКАЯ ИЗ ПВХ ДЛЯ МУССА	261
ЛИМОНОВЫЖИМАЛКА	517
ЛОЖКА	84-85, 90, 91, 107, 246, 388, 473-478
ЛОЖКА ДЛЯ СМАЗКИ	99-100
ЛОЖКА КОКТЕЙЛЬНАЯ	517
ЛОЖКА СЕРВИРОВОЧНАЯ	85, 107
ЛОМТЕРЕЗКА	125-126
ЛОПАТКА ДЛЯ КАРТОФЕЛЬНЫХ ЧИПСОВ	97
ЛОПАТКА ДЛЯ ПИЦЦЫ	78
ЛОПАТКА ДЛЯ РЫБЫ	83, 99
ЛОПАТКА ДЛЯ СБОРА ОВОЩЕЙ	140
ЛОПАТКА ДЛЯ ТОРТОВ	100
ЛОПАТКА ДЛЯ ФАСТ-ФУДА	99
ЛОПАТКА	83, 91, 98, 107, 246, 473-478
ЛОТКИ ДЛЯ МОРОЖЕНОГО	240
МАНДОЛИНЫ	136
МАШИНА "VERSATIL MACHINE"	131
МАШИНА ДЛЯ ВЫЖИМАНИЯ	131
МЕЛАМИНОВАЯ ЁМКость SLIM	396-397
МЕЛАМИНОВАЯ ПОСУДА ДЛЯ ПРЕЗЕНТАЦИИ	360-403
МЕЛКИ ДЛЯ ОТМЕТОК	483
МЕЛЬНИЦА ДЛЯ ПЕРЦА	502
МЕЛЬНИЦА ДЛЯ СОЛИ	502
МЕНЗУРКА	145
МЕРНЫЕ ЛОЖКИ	145
МЕТАЛЛИЧЕСКАЯ ЩЕТКА	120
МЕШКИ КОНДИТЕРСКИЕ	263-264
МИКРОВОЛНОВАЯ ПЕЧЬ	295
МИНИАТЮРЫ ИЗ МЕЛАМИНА	401-402
МИНИАТЮРЫ ЧУГУННЫЕ	486-487
МИСКА КОНИЧЕСКАЯ	244
МОЛОЧНИК	524-526
МОРОЖЕНИЦА	354-357
МОРОЖЕНОЕ	344-358, 238-240
МРАМОРНАЯ ПОДСТАВКА ДЛЯ ПРЕЗЕНТАЦИИ	393
НАБОР КАСТРЮЛЬ IDEA	34-36
НАБОР КАСТРЮЛЬ ПРЕЗЕНТАЦИОННЫЙ	416-421
НАБОР КАСТРЮЛЬ ЦВЕТНОЙ	32, 404-409
НАБОРЫ SUBIS	430-433
НАБОРЫ ДЛЯ СПЕЦИЙ	118
НАГРЕВАТЕЛИ	324-325, 333-334, 409, 411
НАКАЛЫВАТЕЛЬ ДЛЯ ЗАМЕТОК	505
НАСАДКА	265-268
НАСАДКА ИЗ ПОЛИКАРБОНАТА	268
НАСТОЛЬНАЯ ПОДСТАВКА ПОД ПОДНОС ДЛЯ МОРЕПРОДУКТОВ	505
НАСТОЛЬНЫЙ МИКСЕР	306
НАТУРАЛЬНЫЙ БАМБУК И ДЕРЕВО	492-493
НЕРЖАВЕЮЩАЯ КРЫШКА ДЛЯ ТАРЕЛОК	509
НОЖ	473, 475, 478
НОЖ / ЗАПАСНОЙ ВАЛИК	135
НОЖ ДЛЯ НАРЕЗКИ КАРТОФЕЛЯ ФРИ	127
НОЖ ДЛЯ РЕЗКИ ТОМАТОВ	133
НОЖ ДЛЯ РЕЗКИ ЯБЛОК И ВЫЕМКИ СЕРДЦЕВИНЫ	135
НОЖ ДЛЯ РЕЗКИ ЯИЦ	135
НОМЕРА ДЛЯ СТОЛОВ	504
ОВАЛЬНОЕ БЛЮДО	364, 367-368, 385-386, 470
ОВАЛЬНЫЙ ПОДНОС	470

Артикул	Страница
ОСНОВА ДЛЯ ПИЦЦЫ	77
ОТКРЫВАЛКА ПРОМЫШЛЕННАЯ.....	135
ОТКРЫВАТЕЛЬ УСТРИЦ.....	134
ОХЛАДИТЕЛЬ БУТЫЛОК ДЛЯ БУФЕТА SUBIC	437
ОХЛАДИТЕЛЬНАЯ ПАНЕЛЬ.....	471
ОХЛАДИТЕЛЬНЫЙ ЧЕХОЛ.....	513
ПАНЕЛЬ УГЛОВАЯ АДАПТИРОВОЧНАЯ.....	453
ПАРОВАРКА.....	24, 334, 340, 409, 411, 462
ПЕПЕЛЬНИЦА.....	403, 506
ПЕРФОРИРОВАННОЕ ДНО	
GASTRONORM.....	157, 158, 161, 167, 169, 171, 208
ПИАЛА.....	106, 364, 366, 369, 372, 381, 402, 467-469, 544
ПИАЛА С ДВОЙНЫМИ СТЕНКАМИ.....	106, 467-469
ПИАЛА УДЛИНЕННАЯ С НАКЛОНОМ.....	467
ПЛАСТМАССОВАЯ КРЫШКА ДЛЯ ТАРЕЛОК.....	509
ПЛАСТМАССОВОЕ ВЕДРО ДЛЯ ЛЬДА.....	512
ПЛОСКАЯ СКОВОРОДА-ГРИЛЬ С АЛЮМИНИЕВЫМИ РУЧКАМИ.....	75
ПОДНОС.....	70-73, 76, 366, 368-371, 380-386, 378, 470, 522, 541-542
ПОДНОС GASTRONORM.....	70
ПОДНОС ДЛЯ ПРЕЗЕНТАЦИИ.....	389
ПОДНОС ДЛЯ ПРИБОРОВ.....	542
ПОДНОС ДЛЯ САМООБСЛУЖИВАНИЯ ИЗ НЕРЖ. СТАЛИ.....	541-542
ПОДНОС ИЗОТЕРМИЧЕСКИЙ.....	544
ПОДНОС КОНДИТЕРСКИЙ.....	72-73, 76, 389
ПОДНОС ОФИЦИАНТА.....	522
ПОДНОС ФАСТ-ФУД.....	541
ПОДНОСЫ SUBIC.....	436
ПОДНОСЫ ИЗ СТЕКЛОВОЛОКНА.....	541
ПОДНОСЫ С ПРОТИВОСКОЛЬЗЯЩИМ ПОКРЫТИЕМ.....	505, 522
ПОДОГРЕВАТЕЛИ ПИЩИ.....	326-333
ПОДОГРЕВАТЕЛЬ.....	326-333
ПОДОГРЕВАТЕЛЬ РЕТРО.....	328-329
ПОДОГРЕВАТЕЛЬ ТАРЕЛОК.....	343
ПОДСАЛФЕТНИК.....	507
ПОДСТАВКА ДЛЯ КРЫШЕК GN.....	163
ПОДСТАВКА ДЛЯ ПИЦЦЫ.....	78
ПОДСТАВКА ДЛЯ ПОДНОСОВ БОЛЬШОГО РАЗМЕРА.....	505
ПОДСТАВКА ДЛЯ ТОРТА.....	252
ПОДСТАВКА ДЛЯ ШПАЖЕК. SUBIC.....	435
ПОДСТАВКА ПОД ВЕДРО ДЛЯ ШАМПАНСКОГО.....	513
ПОДСТАВКА ПРЕЗЕНТАЦИОННАЯ ИЗ БЕЛОГО ДЕРЕВА.....	391
ПОЛКИ.....	218-235
ПОРЦИОННАЯ ЛОЖКА С НАЖАТИЕМ.....	238-239
ПОРЦИОННАЯ ЛОЖКА ДЛЯ МОРОЖЕНОГО.....	90, 107, 238-239
ПРЕЗЕНТАЦИОННАЯ ВИТРИНА.....	454-455
ПРЕЗЕНТАЦИОННАЯ ЛОПАТКА.....	390
ПРЕЗЕНТАЦИОННАЯ ПОДСТАВКА ДЛЯ ШПАЖЕК. SUBIC.....	435
ПРИСПОСОБЛЕНИЯ ДЛЯ ДОЗИРОВАНИЯ.....	534-539
ПРОБКА ДЛЯ ШАМПАНСКОГО.....	520
ПРОЗРАЧНЫЕ КРЫШКИ GN.....	455
ПРОТЕКТОР ПРОТИВОДЫХАТЕЛЬНЫЙ.....	462
ПРОТИВОАЛЛЕРГИЧЕСКИЙ.....	30-31, 101-109
ПРОТИВОМИКРОБНЫЙ.....	86-88
ПРОФИЛЬ РАЗДЕЛИТЕЛЬНЫЙ.....	157, 414
ПРОЦЕССОР РУЧНОЙ АДАПТИРУЕМЫЙ.....	135
ПРОЦЕССОРЫ РУЧНЫЕ ДЛЯ ПЕРЕРАБОТКИ ПРОДУКТОВ.....	121-136
ПЮРЕШНИЦА.....	115
РАМКИ ДЛЯ ПОДНОСОВ.....	72

Артикул	Страница
РАСПРЕДЕЛИТЕЛЬ ДЛЯ СОКА.....	434, 443
РЕГУЛИРУЕМАЯ ТЕЛЕЖКА ДЛЯ ТАРЕЛОК.....	214
РЕШЕТКИ GN.....	74
РЕШЕТКИ КОНДИТЕРСКИЕ.....	74, 254
РИСОВАРКА.....	296
РОЛИК ДЛЯ НАРЕЗКИ ПИЦЦЫ.....	99
РУКАВИЦА.....	146
САЛАТНИЦА АКРИЛЛОВАЯ.....	471
САЛФЕТНИЦА SUBIC.....	437
САХАРНИЦА.....	525
СЕРВИРОВОЧНЫЕ ПРИНАДЛЕЖНОСТИ.....	473-481
СЕРИИ BLACK.....	41, 75
СЕРИЯ GASTRONORM ИЗ ПОЛИКАРБОНАТА.....	166-167
СЕРИЯ GASTRONORM С УТОЛЩЕННЫМ ДНОМ СЭНДВИЧ.....	165
СЕРИЯ ALU-PRO.....	37-39
СЕРИЯ FLAP-RACK®.....	174-191
СЕРИЯ GASTRONORM ИЗ ПОЛИПРОПИЛЕНА.....	170-171
СЕРИЯ GASTRONORM, НЕРЖ.СТАЛЬ.....	156-162, 165
СЕРИЯ INOX-PRO.....	20-26
СЕРИЯ MULTIMETAL.....	43, 57
СЕРИЯ PUJADAS 1921. ЧУГУН СВЕРХЛЕГКИЙ	
ДЛЯ ИНДУКЦИОННЫХ ПЛИТ.....	61
СЕРИЯ TOP LINE.....	28-29
СИЛИКОНОВАЯ БУМАГА.....	78
СИЛИКОНОВАЯ ЛЕНТА ДЛЯ ЗАКУПОРКИ.....	164
СИЛИКОНОВАЯ САЛФЕТКА.....	146
СИЛИКОНОВАЯ САЛФЕТКА.....	78
СИТЕЧКО-ШАРИК ДЛЯ ЗАВАРИВАНИЯ ТРАВЯНОГО ЧАЯ.....	527
СИТО.....	252
СКАЛКА ДЛЯ ТЕСТА.....	247-248
СКАТЕРТЬ ПРОТИВОСКОЛЬЗЯЩАЯ ДЛЯ ПОДНОСА.....	522
СКОВОРОДА "LYONNAISE".....	63
СКОВОРОДА IDEA.....	52
СКОВОРОДА MULTIMETAL.....	57
СКОВОРОДА PUJADAS 1921.....	61
СКОВОРОДА VIOLET.....	56
СКОВОРОДА АЛЮМИНИЕВАЯ.....	54-56
СКОВОРОДА АЛЮМИНИЕВАЯ.....	58-59
СКОВОРОДА ГЛУБОКАЯ, ЭМАЛИРОВАННАЯ, С РУЧКАМИ.....	64
СКОВОРОДА ГРИЛЬ.....	68-69, 75
СКОВОРОДА ДЛЯ БЛИНОВ.....	56
СКОВОРОДА ДЛЯ ФРАНЦУЗСКИХ БЛИНОВ.....	56, 59, 60, 63
СКОВОРОДА СЕРИИ BLACK.....	58-59
СКОВОРОДА, НЕРЖ. СТАЛЬ.....	50-52
СКОВОРОДЫ.....	48-63
СКОВОРОДЫ COOL • LINE.....	408
СКРЕБОК.....	99-100, 120, 249
СКРЕБОК ДЛЯ СБОРА КРОШЕК.....	504
СКРЕБОК ДЛЯ ЧИСТКИ РЫБЫ.....	120
СЛАЙСЕР.....	130
СЛАЙСЕР ДЛЯ ЗЕЛЕННОГО САЛАТА.....	128
СЛАЙСЕР ДЛЯ КУБИКОВ.....	134
СЛАЙСЕР ДЛЯ ЛУКА.....	129
СЛАЙСЕР ДЛЯ СЫРА.....	134
СЛАЙСЕР ДЛЯ ФРУКТОВ И ОВОЩЕЙ.....	129
СЛАНЦЕВО-МРАМОРНАЯ ПОДСТАВКА ДЛЯ ПРЕЗЕНТАЦИИ.....	393
СЛАНЦЕВЫЕ ДОСКИ ДЛЯ ПРЕЗЕНТАЦИИ.....	490-491
СОВОК.....	244

Артикул	Страница
СОСУД ДЛЯ СОУСОВ	371, 373, 400, 402
СОТЕЙНИК VIOLET	30-31
СОТЕЙНИК АЛЮМИНИЕВЫЙ	39
СОТЕЙНИК ИЗ НЕРЖАВЕЮЩЕЙ СТАЛИ	24
СОУСНИК	503
СОУСНИК / НАБОР ДЛЯ ЗАКУСКИ	503
СОУСНИК COOL • LINE	32
СОУСНИК IDEA	35-36
СОУСНИК АЛЮМИНИЕВАЯ	39
СОУСНИК С ВОЛНИСТЫМ КРАЕМ	503
СТАКАН	376, 545
СТЕНД ДЛЯ ГАСТРОЕМКОСТЕЙ GN	163, 399
СТОЛ ДЛЯ НАРЕЗКИ	140
СТОЛИК БУФЕТНЫЙ SUBIC	437
СУПНИЦА	471
ТАБЛИЧКА "ЗАРЕЗЕРВИРОВАНО"	504
ТАБЛИЧКА "НЕ КУРИТЬ"	504
ТАРЕЛКИ	364-369, 373, 374, 376-379, 387, 544
ТАРЕЛКИ ЦВЕТНЫЕ	377
ТЕЛЕЖКА GUERIDON	446
ТЕЛЕЖКА ДВОЙНАЯ ДЛЯ ПОДНОСОВ ФАСТ-ФУД	209
ТЕЛЕЖКА ДЕРЕВЯННАЯ	444-447
ТЕЛЕЖКА ДЛЯ ГАСТРОЕМКОСТЕЙ GASTRONORM	204-208
ТЕЛЕЖКА ДЛЯ КОРЗИНОК	212
ТЕЛЕЖКА ДЛЯ ЛЬДА	215
ТЕЛЕЖКА ДЛЯ ПРИБОРОВ	447, 210, 541
ТЕЛЕЖКА ДЛЯ РАЗМОРАЖИВАНИЯ	208
ТЕЛЕЖКА ДЛЯ РАЗМОРАЖИВАНИЯ GASTRONORM	208
ТЕЛЕЖКА ДЛЯ СБОРА ПОСУДЫ	200, 203
ТЕЛЕЖКА ДЛЯ ТЯЖЕЛЫХ ГРУЗОВ	211
ТЕЛЕЖКА ПЛАСТМАССОВАЯ	200, 214-215
ТЕЛЕЖКА С НАПРАВЛЯЮЩИМИ	204-209, 211-212
ТЕЛЕЖКА С НАПРАВЛЯЮЩИМИ, РАЗБОРНАЯ	205-207
ТЕЛЕЖКА С РАБОЧЕЙ ПОВЕРХНОСТЬЮ	211
ТЕЛЕЖКА СЕРВИРОВОЧНАЯ АЛЮМИНИЕВАЯ	200
ТЕЛЕЖКА СЕРВИРОВОЧНАЯ ИЗ НЕРЖ. СТАЛИ	201-203
ТЕЛЕЖКА СЕРВИРОВОЧНАЯ РАЗБОРНАЯ	202
ТЕЛЕЖКА ШПИЛЬКА	205-207
ТЕПЛОВОЙ ШКАФ	341-342
ТЕРКА	110-111
ТЕРМОМЕТР	143-145
ТЕРМОС С ДОЗАТОРОМ	528-529
ТОСТЕР	298-302
ТОЧИЛО ДЛЯ НОЖЕЙ	322
ТРАФАРЕТЫ	420-421
ТРЕНОЖНИК ДЛЯ КАСТРЮЛИ ПАЭЛЬЯ	65
ТЯПКА ДЛЯ ОТБИВАНИЯ МЯСА	119
УКОМПЛЕКТОВАННЫЕ НАБОРЫ ПОЛОК	225-231
УНИВЕРСАЛЬНАЯ КОНЗИНКА	186, 196
УНИВЕРСАЛЬНАЯ ПРОБКА	520
УЧРЕЖДЕНИЯ	541-542, 544-545
ФОНТАН ДЛЯ ШОКОЛАДНОГО ФОНДЮ	340
ФОРМА ГНЕЗДО	84
ФОРМА ДЛЯ ВЫПЕЧКИ "СЛЕЗА"	261
ФОРМА ДЛЯ ВЫПЕЧКИ "КЕЙК"	255, 262, 271
ФОРМА ДЛЯ ВЫПЕЧКИ "СЕРДЦЕ"	261
ФОРМА ДЛЯ ВЫПЕЧКИ ОВАЛЬНАЯ	257, 261
ФОРМА ДЛЯ ВЫПЕЧКИ ПОЛУСФЕРА	244

Артикул	Страница
ФОРМА ДЛЯ ВЫПЕЧКИ ШЕСТИУГОЛЬНАЯ	261
ФОРМА ДЛЯ ПИЦЦЫ	77
ФОРМА ДЛЯ РУЛЕТА	262
ФОРМА ДЛЯ ЯЙЦА	119
ФОРМА-СТАКАНЧИК ДЛЯ ФЛАНА	262, 271
ФОРМЫ ДЛЯ ВЫПЕЧКИ "FLEXIPAN"	274-281
ФОРМЫ ДЛЯ ВЫПЕЧКИ СИЛИКОНОВЫЕ	269-273
ФОРМЫ ДЛЯ ВЫРЕЗАНИЯ ТЕСТА	247, 259
ФОРМЫ КОНДИТЕРСКИЕ	255-258, 260-262, 269-281
ФОРМЫ СИЛИКОНОВЫЕ 600 X 400	272-273
ФРИТЮРНИЦА	292-293
ЦИФРОВЫЕ КУХОННЫЕ ЧАСЫ	143
ЧАЙНИК	525-527
ЧАЙНИК С ФИЛЬТРОМ	527
ЧАЙНИЧЕК ДЛЯ ТРАВЯНОГО ЧАЯ	527
ЧАФИНГ-ДИШ	456-461
ЧАФИНГ-ДИШ INTRIGUE	456-457
ЧАФИНГ-ДИШ NEW YORK, NEW YORK	458-459
ЧАФИНГ-ДИШ ЭКОНОМИЧНЫЕ	461
ЧАФИНГ-ДИШ, ДОПОЛНИТЕЛЬНЫЕ ПРИНАДЛЕЖНОСТИ	457, 462-463
ЧАША	388
ЧАША ДЛЯ МОРОЖЕНОГО	239
ШАМПАННИЦА	512-514
ШАМПАННИЦА, ДОПОЛНИТЕЛЬНЫЕ ПРИНАДЛЕЖНОСТИ	520-521
ШАМПУР / ПАЛОЧКА	505
ШЕЙКЕР	516
ШТОПОР	521
ШТОПОР НАСТЕННЫЙ	521
ШУМОВКА	83-84, 91, 473-476
ШУМОВКА СЕТЧАТАЯ	84
ЩЕПЦЫ СЕРВИРОВОЧНЫЕ	479-481
ЩИПЦЫ	91, 93-97, 106, 478-481, 493, 517
ЩИПЦЫ ДЛЯ БУФЕТА	94-95, 479-480
ЩИПЦЫ ДЛЯ ВЫПЕЧКИ	480
ЩИПЦЫ ДЛЯ КОЛБАСНЫХ ИЗДЕЛИЙ	481
ЩИПЦЫ ДЛЯ КОЛКИ ОРЕХОВ	481
ЩИПЦЫ ДЛЯ МОРЕПРОДУКТОВ	481
ЩИПЦЫ СЕРВИРОВОЧНЫЕ	93
ЭЛЕКТРИЧЕСКАЯ КАСТРЮЛЯ	334
ЭЛЕКТРИЧЕСКАЯ ЛАМПА	251
ЭЛЕКТРИЧЕСКИЙ ЭЛЕМЕНТ ДЛЯ ЧАФИНДИША	463
ЭЛЕКТРИЧЕСКИЙ СЛАЙСЕР ДЛЯ КОЛБАСНЫХ ИЗДЕЛИЙ	307
ЯЩИК ДЛЯ ПРИБОРОВ ДЛЯ СЕРВИРОВОЧНОЙ ТЕЛЕЖКИ	203

ÍNDICE NUMÉRICO / NUMERICAL INDEX /
INDEX NUMÉRIQUE / NUMMERISCHER INDEX

REF.	Pag.	REF.	Pag.	REF.	Pag.	REF.	Pag.	REF.	Pag.
0643N	133	15604	129	4075803	307	46586	467	47146	90
0643SGN	133	1612-06	522	4075902	307	46587	467	47147	107
0644N	133	1811	134	4075903	307	4658715	469	47150	238
0644SGN	133	1812	134	4076002	307	4658725	469	47151	238
0653	133	1823	134	4076003	307	4658750	469	47152	238
0654	133	1837	134	40761	306	4658760	469	47153	238
1009-01	178	1838	134	40762	306	4658765	106	47154	238
1009-02	178	1853	134	40763	306	46590	467	47155	238
1009-03	178	19184	453	40764	306	4659015	469	47156	238
1009-04	178	19196	453	40765	307	4659025	469	47157	238
1009-05	178	2208-1354	117	40766	307	4659050	469	47158	238
1009-06	178	2331-99	518	40767	307	4659060	469	47159	238
1009-08	178	25154	339	40768	307	4659065	106	47160	238
1009-19	178	26120-13	118	40769	307	46591	467	47161	238
1009-32	178	26240-13	118	40770	307	4659115	469	47169	238
1078-13	509	26320-13	118	40771	307	4659125	469	47170	238
1400	136	2803-18	254	40772	307	4659150	469	47171	238
1474-0606	522	2808-13	117	40773	307	4659160	469	47172	238
1476-0606	522	2812-13	117	40774	307	4659165	106	47200	238
15000	126	2908-13	118	40775	307	46592	467	47274	238
15001	126	2912-13	118	40776	307	4659215	469	47275	238
15002	126	306	130	40777	307	4659225	469	47276	238
15003	126	308	130	40778	307	4659250	469	47277	238
15005	126	3100020	414	40779	307	4659260	469	47278	238
15006	126	3100040	414	40780	307	4659265	106	47279	238
15007	126	3100220	414	434	128	46665	467	47322	97
15008	126	3100240	414	435	128	46666	467	47325	97
1500-C80	105	3100320	414	4400N	128	46667	467	47326	97
15016	126	3100321	414	4408	128	46668	467	47329	97
15017	126	3100340	414	45682	127	46669	467	47378	107
15050	126	3100341	414	45749-1	127	46671	339	47390	90
15052	126	3101015	413	45750-1	127	46672	339	47391	90
15053	126	3101020	413	45751-1	127	4667470	465	47392	90
15054	126	3101040	413	46009	453	4667570	465	47393	90
15055	126	3101120	413	4600960	453	4667670	465	47395	90
15058	126	3101220	413	46070	458	46714	503	47396	90
15059	126	3101240	413	46080	458	46716	503	47397	90
15060	126	3102015	413	46090	459	46760	481	47398	90
15061	126	3102020	413	46093	459	46774	520	47399	90
15062	126	3102040	413	46094	459	46791	516	47400	107
15063	126	3102120	414	46095	459	46793	516	47403	90
15064	126	3102220	413	46110	340	4689760	90	4741-06	519
15065	126	3102240	413	46115	340	4689815	90	4743-06	519
15067	126	3103040	413	46125	457	4689830	90	4747	519
15068	126	3316-13	117	46130	457	4689840	90	47488	327
15069	126	3316-13191	117	46131	457	4689850	90	47488	332
15070	126	3332-13	117	46134	457	4689860	90	47490	327
15072	126	336	130	46135	457	4689960	90	47490	332
15073	126	338	130	46136	457	46926	479	47602	521
15076	126	3616	523	46137	457	46928	480	47609	520
15078	126	3628	523	46268	459	46929	481	47612	516
15081	126	3632	523	46280	459	46938	479	47619	467
15082	126	3648	523	46311-2	329	47002	107	4761915	469
15083	126	3664	523	4635210	464	47003	107	4761925	469
15085	126	3821-06	538	46407-2	329	47004	107	4761950	469
15086	126	3825-06	538	46527	329	47005	107	4761960	469
15103	133	400N	128	46569	467	47006	107	4761965	106
15104	133	401N	128	4656915	469	47042	97	47632	467
15105	133	402NC	128	4656925	469	47046	97	4763215	469
15113	133	403N	128	4656950	469	47049	97	4763225	469
15114	133	403NH	129	4656960	469	47104	517	4763250	469
15115	133	4075502	306	4656965	106	47139	90	4763260	469
15149	136	4075503	306	46575	467	47140	90	4763265	106
15205	133	4075602	306	46576	467	47141	90	47634	467
15209	133	4075603	306	46577	467	47142	90	4763415	469
1522-C80	105	4075702	307	46582	467	47143	90	4763425	469
1527-C80	105	4075703	307	46584	467	47144	90	4763450	469
15601	129	4075802	307	46585	467	47145	90	4763460	469

ÍNDICE NUMÉRICO / NUMERICAL INDEX /
INDEX NUMÉRIQUE / NUMMERISCHER INDEX

REF.	Pag.	REF.	Pag.	REF.	Pag.	REF.	Pag.	REF.	Pag.
4763465	106	4808720	98	521035	353	52760	194	55490	125
47635	467	4808780	107	52160	529	52761	194	55491	125
4763515	469	4808815	98	52162	529	52762	194	55492	125
4763525	469	4808820	98	52164	529	52763	194	55493	125
4763550	469	4808880	107	52170	529	52764	194	55494	125
4763560	469	4808915	98	52172	529	52765	194	55495	125
4763565	106	4808920	98	52174	529	52766	194	595027502	289
47637	467	48144	475	5220	76	52767	194	595027503	289
4763715	469	48148	475	5223	76	52768	194	595087502	289
4763725	469	4842-06	539	5228	76	52769	194	595087503	289
4763750	469	4843-06	539	52643	186	52770	194	59601	286
4763760	469	484C	128	52670	196	52771	194	59602	286
4763765	106	485	128	52671	196	52772	195	5960810I	290
47703	127	485	129	52672	196	52773	195	5960820I	290
47704	131	49130	457	52680	196	52774	195	5960835I	290
47713	127	49136	457	52681	196	52775	195	5960845I	290
47714	127	4916-13	117	52682	196	52776	195	5960910I	290
47715	127	4924-13	117	52683	196	52777	195	5960920I	290
4780610	96	4932-13	117	52684	195	52778	195	5960935I	290
4780620	95	49410	418	52689	195	52779	195	5960945I	290
4780630	95	49411	418	52691	194	52780	195	59641	290
4780640	95	49412	418	52692	194	52781	195	59642	290
4780650	95	49413	418	52693	194	52782	195	59650	286
4780660	95	49414	419	52694	194	52783	195	59651	286
4780670	95	49415	419	52695	196	52784	195	6000-13	530
4780680	106	49416	418	52696	196	52785	195	6001X	322
4780910	96	49417	418	52699	195	52786	195	606N	130
4780912	96	49418	418	52702	194	52787	195	62300	509
478091280	106	49419	419	52703	194	52788	195	62302	509
4780920	95	49420	418	52704	194	52789	195	62303	509
4780922	96	49423	419	52706	194	52790	195	62312	509
4780930	95	49424	418	52707	194	52811	195	62313	509
4780940	95	49425	419	52708	194	52812	195	62314	509
4780950	95	49426	419	52709	194	52813	195	62315	509
4780960	95	49427	419	52710	195	52816	195	62318	509
4780970	95	49428	418	52711	195	52817	195	62321	509
4780980	106	49429	419	52712	195	52832	195	62326	509
4781210	96	49430	419	52713	195	5284120	98	6412230	88
4781212	96	49431	419	52714	195	5284220	90	6412335	88
4781220	95	49432	419	52715	195	5284320	90	6412445	88
4781222	96	49433	419	52716	195	52844	195	6412655	88
4781230	95	49434	419	52717	195	52845	195	6412865	88
4781240	95	49435	419	52718	194	52846	195	64130	85
4781250	95	4961-1301	118	52719	194	52847	195	64132	85
4781260	95	4961-1308	118	52720	194	52848	195	6414015	85
4781270	95	4961-13191	118	52721	194	52849	195	6414030	85
4781280	106	4961-1332	118	52722	195	5303	76	6414040	85
4781610	96	4980120	82	52723	195	5324-13	118	6414050	85
4781612	96	4980230	82	52724	195	5382	134	6414070	85
4781620	95	4980280	106	52725	195	55179	104	6414080	107
4781622	96	4980322	329	52726	194	55457	125	6414215	85
4781630	95	4980335	82	52727	194	55458	125	6414230	85
4781640	95	4980422	329	52728	194	55459	125	6414240	85
4781650	95	4980445	82	52729	194	55460	125	6414250	85
4781660	95	4980480	106	52730	194	55470	125	6414270	85
4781670	95	4980622	329	52731	194	55471	125	6414280	107
4781680	106	4980655	82	52732	194	55472	125	6422230	88
4790910	96	4980822	329	52733	195	55473	125	6422335	88
4791210	96	4980865	82	52734	195	55477	125	6422445	88
4791610	96	500N	129	52735	195	55478	125	6422655	88
47933	244	501N	129	52736	194	55479	125	6422865	88
47934	244	502N	129	52737	194	55480	125	6432230	88
47935	244	503N	129	52738	195	55481	125	6432335	88
47938	244	509	129	52739	195	55482	125	6432445	88
47943	244	510	129	52740	195	55483	125	6432480	106
4804-06	539	511	129	52754	194	55484	125	6432655	88
4806-06	539	512	129	52755	194	55485	125	6432865	88
4808715	98	521030	353	52757	194	55486	125	6433230	88

ÍNDICE NUMÉRICO / NUMERICAL INDEX /
INDEX NUMÉRIQUE / NUMMERISCHER INDEX

REF.	Pag.	REF.	Pag.	REF.	Pag.	REF.	Pag.	REF.	Pag.
6433335	88	78730	462	90023	161	CAC95I-10	320	LDS-4CUP	539
6433445	88	78740	462	90042	159	CADJ-1	538	LS02G-LS02H	536
6433480	106	78760	462	90043	161	CADJ-2	538	LS02IB-T1	537
6433580	106	808N	130	90052	159	CADJ-3	536	LS02IS18B-T1	537
6433655	88	808SG	130	90053	161	CADJ-3	538	LS02IVB-T1	537
6433865	88	82005	467	90062	159	CB15VE	321	LS02J-LS02M	537
6525-13	539	82006	467	90063	161	CT2-23035002	299	LS02MS18B-T5	537
6950502	287	82060	470	90082	159	CT2-23035003	299	LS02MVS18B-T5	537
6950503	287	82061	470	90102	159	CT4-2301000	298	LS02PB-T1	537
6954302	287	82062	470	90112	159	CT4-23080002	298	LS02PS18B-T1	537
6954303	287	82090	470	90122	159	CT4-23080003	298	LS02PVB-T1	537
6954702	287	82091	470	90142	159	CTC-3X2V	539	MB98719	462
6954703	287	82092	470	90162	159	CTNO-06	539	MB98720	462
700-1	130	82093	470	90182	159	CTS1000E	300	MB98721	462
700-4	130	82094	470	90202	159	E111X-302I-A	347	MB98722	462
704	130	82095	470	90212	159	E112X-302	351	MBA92821	462
706	130	8242010	420	90213	161	E131X-302I2	348	MX1000XTPEE	320
708	130	8242014	420	90222	159	F111X-302I2	347	MX1000XTXEE	320
712	130	8242310	420	90223	161	F112X-302	352	MX1100XTXSEE	320
7217310	329	8242314	420	90242	159	F131X-302I2	348	MX1200XTXEE	319
7217335	329	8242414	420	90243	161	F144X-302I2	350	MX1500XTXSEE	319
7217350	329	8242514	420	90252	159	F231X-302I2P	349	N-0001B	164
7217355	329	8242610	420	90262	159	G1-L	536	N-0002B	164
7217360	329	8242614	420	90263	161	G1LLDS-T1	537	N-0003B	164
7217410	329	8242710	420	90282	159	G2H-LC-T1-T2	536	N-0006B	164
7217435	329	8242714	420	90302	160	G2H-LL-T1-T1	536	P1	536
7217450	329	8242810	421	90312	160	G2H-LP-T1-T4	536	P100.002P	163
7217455	329	8242814	421	90322	160	G2VLCCLDS-T1-T2	537	P100.003P	163
7217460	329	8242914	421	90342	160	G2V-LC-T1-T2	536	P100.004P	163
7217810	329	8243014	421	90352	160	G2VLLLLDS-T1-T1	537	P100.005P	163
7217835	329	8243114	421	90362	160	G2V-LL-T1-T1	536	P100.006P	163
7217850	329	8243210	421	90382	160	G2V-LP-T1-T4	536	P100.008P	163
7217855	329	8243214	421	90402	160	G3H-LCC-T1-T2-T2	536	P100.511	492
7217860	329	8243314	421	90412	160	G3H-LCP-T1-T2-T4	536	P100.512	492
7217910	329	86100	541	90422	160	G3H-LCS-T1-T2-T3	536	P100.520	492
7217935	329	86101	541	90442	160	G3H-LLL-T1-T1-T1	536	P100.521	492
7217950	329	86103	541	90452	160	G3VLCCLDS-T1-T2-T2	537	P100.522	492
7217955	329	86104	541	90462	160	G3V-LCC-T1-T2-T2	536	P100.530	493
7217960	329	86105	541	90482	160	G3V-LCP-T1-T2-T4	536	P100.531	493
72522	332	86106	541	90502	160	G3V-LCS-T1-T2-T3	536	P100.540	493
72550	333	86107	541	90512	160	G3V-LLL-T1-T1-T1	536	P100.541	493
72553	333	86108	541	90522	160	G4H-LCCC-T1-T2-T2-T2	536	P100.542	493
72620	333	86109	541	90542	160	G4H-LCCP-T1-T2-T2-T4	536	P100.543	493
72630	333	86110	541	90552	160	G4H-LCCS-T1-T2-T2-T3	536	P100.544	493
72958	334	86111	541	90562	160	G4H-LLCC-T1-T1-T2-T2	536	P100.550	493
72959	334	86113	541	90622	160	G4V-LCCC-T1-T2-T2-T2	536	P100.551	493
74110210	327	86114	541	90642	160	G4V-LCCP-T1-T2-T2-T4	536	P100.552	493
74110240	327	86115	541	90662	160	G4V-LCCS-T1-T2-T2-T3	536	P100.553	493
741102D	327	86116	541	90682	160	G4V-LLCC-T1-T1-T2-T2	536	P100.554	493
74110310	327	86117	541	90922	160	G4X-LCCC-T1-T2-T2-T2	536	P100.570	493
74110340	327	86118	541	90942	160	G4X-LCCP-T1-T2-T2-T4	536	P100.571	493
741103D	327	86119	541	918-13	509	G4X-LCCS-T1-T2-T2-T3	536	P100.572	493
7470210	327	86120	541	93100	160	G4X-LLCC-T1-T1-T2-T2	536	P100.600	492
7470240	327	86121	541	93110	160	H1-L-T1	536	P100.601	492
74702D	327	86123	541	93200	160	H2V-LL-T1-T1	536	P100.740	496
7470310	327	86124	541	93300	160	H3V-LLL-T1-T1-T1	536	P100.741	496
7470340	327	86125	541	93400	160	H4V-4L-T1-T1-T1-T1	536	P100.742	496
74703D	327	86126	541	93500	160	ICE140-06	215	P100.752	496
75013	414	86127	541	ADC-4	214	INC-80	536	P100.753	496
75015	414	86128	541	ADP	214	INC-80	538	P100.754	496
7512-06	539	86129	541	ADVC	214	INC-80S18	538	P100.755	496
77540	465	88184	327	BB255E	313	J1-L-T5	537	P100.760	496
77541	465	88204	327	BB300E	313	J2H-LL-T5-T5	537	P100.761	496
78184	332	90002	159	BB340E	313	J2V-LL-T5-T5	537	P100.770	496
78204	332	90012	159	CAC132	313	J3V-LLL-T5-T5-T5	537	P100.780	496
78710	462	90013	161	CAC93XI	320	LBC1418-3F-06	454	P100.790	497
78720	462	9002	76	CAC93XI-10	320	LD2-2	538	P100.792	497
78725	462	90022	159	CAC95I	320	LD3-2	538	P100.800	497

ÍNDICE NUMÉRICO / NUMERICAL INDEX /
INDEX NUMÉRIQUE / NUMMERISCHER INDEX

REF.	Pag.	REF.	Pag.	REF.	Pag.	REF.	Pag.	REF.	Pag.
P100.803	497	P110.0P1	169	P114.070	69	P120.124	56	P128.026	54
P100.804	497	P110.0P1	170	P114.540	69	P120.128	56	P128.028	54
P100.805	497	P110.0P2	162	P114.545	69	P120.201	156	P128.032	54
P100.807	495	P110.0P3	162	P115.000	157	P120.401	156	P128.036	54
P100.808	495	P110.0P4	162	P115.000	208	P120.651	156	P128.040	54
P100.813	497	P110.0P5	162	P115.020	38	P120.652	158	P128.120	54
P100.814	497	P110.0P6	172	P115.024	38	P120.6BF	168	P128.124	54
P100.816	495	P110.201	156	P115.028	38	P120.6C1	166	P128.128	54
P100.817	495	P110.202	158	P115.032	38	P120.6F1	165	P128.132	54
P100.820	497	P110.401	156	P115.040	38	P120.6F3A	406	P128.220	54
P100.821	497	P110.402	158	P115.050	38	P120.6F3G	406	P128.224	54
P100.826	495	P110.551	156	P115.060	38	P120.6F3N	406	P128.228	54
P100.827	495	P110.552	158	P115.0BF	169	P120.6F3R	406	P128.232	54
P100.836	495	P110.651	156	P115.0C1	167	P120.6P1	170	P128.320	54
P100.837	495	P110.652	158	P115.0P1	171	P120.820	53	P128.324	54
P100.838	495	P110.6BF	168	P116.125	38	P120.824	53	P128.328	54
P100.840	498	P110.6C1	166	P116.130	38	P120.828	53	P128.332	54
P100.841	498	P110.6F1	165	P116.135	38	P120.832	53	P128.420	54
P100.842	498	P110.6F3A	406	P116.140	38	P120.920	53	P128.424	54
P100.851	498	P110.6F3G	406	P116.145	38	P120.924	53	P128.428	54
P100.860	498	P110.6F3N	406	P116.150	38	P120.928	53	P128.432	54
P100.861	498	P110.6F3R	406	P116.160	38	P120.932	53	P128.920	53
P100.862	498	P110.6P1	170	P117.125	38	P121.001	156	P128.924	53
P100.870	498	P111.001	156	P117.127	38	P121.002	158	P128.928	53
P100.871	498	P111.002	158	P117.130	38	P121.0BF	168	P128.932	53
P100.880	498	P111.0BF	168	P117.132	38	P121.0C1	166	P130.000	162
P100.881	498	P111.0C1	166	P117.135	38	P121.0P1	170	P130.001	162
P100.882	498	P111.0F1	165	P117.138	38	P121.501	156	P130.002	162
P100.890	498	P111.0F2	165	P117.140	38	P121.502	158	P130.004	162
P100.891	498	P111.0P1	170	P117.145	38	P121.5BF	168	P130.0BF	169
P100.892	498	P111.111	157	P117.150	38	P121.5C1	166	P130.0C1	167
P100.900	497	P111.501	156	P117.160	38	P121.5P1	170	P130.0C1	171
P100.931	499	P111.502	158	P118.125	38	P121.5P6	172	P130.0P1	162
P100.932	499	P111.5BF	168	P118.127	38	P122.001	156	P130.0P1	167
P100.940	499	P111.5C1	166	P118.130	38	P122.002	158	P130.0P1	169
P100.950	499	P111.5F1	165	P118.132	38	P122.040	69	P130.0P1	170
P100.951	499	P111.5F2	165	P118.135	38	P122.050	69	P130.0P2	162
P100.955	499	P111.5P1	170	P118.140	38	P122.060	69	P130.0P3	162
P100.960	499	P111.5P6	172	P118.145	38	P122.0BF	168	P130.0P4	162
P100.965	499	P112.001	156	P118.150	38	P122.0C1	166	P130.0P5	162
P103.016	39	P112.002	158	P118.160	38	P122.0P1	170	P130.0P6	172
P103.020	39	P112.020	39	P120.000	162	P122.222	157	P130.201	156
P103.022	39	P112.025	39	P120.001	162	P123.040	73	P130.202	158
P103.024	39	P112.027	39	P120.002	162	P123.060	73	P130.401	156
P104.018	39	P112.030	39	P120.004	162	P123.140	73	P130.402	158
P104.020	39	P112.032	39	P120.005	162	P123.160	73	P130.651	156
P104.022	39	P112.035	39	P120.018	54	P123.240	73	P130.652	158
P104.024	39	P112.038	39	P120.020	54	P123.260	73	P130.6BF	168
P106.020	39	P112.040	39	P120.022	54	P124.020	55	P130.6C1	166
P106.024	39	P112.045	39	P120.024	54	P124.024	55	P130.6P1	171
P106.028	39	P112.050	39	P120.026	54	P124.028	55	P131.001	156
P106.032	39	P112.060	39	P120.028	54	P124.032	55	P131.002	158
P106.040	39	P112.0BF	168	P120.032	54	P124.036	55	P131.022	56
P109.030	114	P112.0C1	166	P120.036	54	P124.040	55	P131.026	56
P109.035	114	P112.0P1	170	P120.040	54	P125.000	157	P131.0BF	168
P109.040	114	P113.030	68	P120.0BF	169	P125.038	55	P131.0C1	166
P109.045	114	P113.035	68	P120.0C1	167	P125.0BF	169	P131.0P1	171
P109.050	114	P113.040	68	P120.0C1	171	P125.0C1	167	P131.501	156
P110.000	162	P113.045	68	P120.0P1	162	P125.0P1	171	P131.502	158
P110.001	162	P113.050	68	P120.0P1	167	P127.024	55	P131.5BF	168
P110.002	162	P113.055	68	P120.0P1	169	P127.028	55	P131.5C1	166
P110.004	162	P113.060	68	P120.0P1	170	P127.032	55	P131.5P1	171
P110.005	162	P113.065	68	P120.0P2	162	P127.036	55	P131.5P6	172
P110.0BF	169	P113.070	68	P120.0P3	162	P127.040	55	P132.001	156
P110.0C1	167	P114.040	69	P120.0P4	162	P128.018	54	P132.002	158
P110.0C1	171	P114.045	69	P120.0P5	162	P128.020	54	P132.040	73
P110.0P1	162	P114.050	69	P120.0P6	172	P128.022	54	P132.060	73
P110.0P1	167	P114.060	69	P120.120	56	P128.024	54	P132.0BF	168

ÍNDICE NUMÉRICO / NUMERICAL INDEX /
INDEX NUMÉRIQUE / NUMMERISCHER INDEX

REF.	Pag.	REF.	Pag.	REF.	Pag.	REF.	Pag.	REF.	Pag.
P132.0C1	166	P148.020	55	P152.030	75	P190.0P1	167	P205.040	22
P132.0P1	171	P148.024	55	P152.035	75	P190.0P1	169	P205.045	22
P132.140	73	P148.028	55	P153.025	75	P190.0P1	170	P205.050	22
P132.160	73	P148.032	55	P153.034	75	P190.0P2	162	P205.060	22
P132.240	73	P149.120	58	P153.050	75	P190.0P3	162	P209.014	23
P132.260	73	P149.124	58	P160.000	162	P190.0P4	162	P209.016	23
P132.365	70	P149.128	58	P160.001	162	P190.0P5	162	P209.018	23
P132.560	70	P149.130	58	P160.002	162	P190.651	157	P209.020	23
P135.000	157	P149.228	58	P160.004	162	P190.6BF	169	P209.022	23
P135.0BF	169	P149.330	59	P160.0BF	169	P190.6C1	167	P209.024	23
P135.0C1	167	P149.520	60	P160.0C1	167	P190.6P1	171	P209.028	23
P135.0P1	171	P149.524	60	P160.0C1	171	P191.001	157	P209.030	23
P135.120	63	P149.528	60	P160.0P1	162	P191.0BF	169	P209.032	23
P135.124	63	P15.000	293	P160.0P1	167	P191.0C1	167	P209.035	23
P135.128	63	P15.001	293	P160.0P1	169	P191.0P1	171	P209.040	23
P135.132	63	P15.002	293	P160.0P1	170	P1912-6	189	P209.045	23
P135.136	63	P15.003	293	P160.0P2	162	P1912-6 F1	189	P209.050	23
P135.140	63	P15.004	304	P160.0P3	162	P195.000	489	P209.060	23
P135.330	63	P15.005	304	P160.0P4	162	P20.041	508	P21.000	483
P135.424	63	P15.006	304	P160.0P5	162	P20.042	508	P21.001	483
P136.006	262	P15.007	304	P160.0P6	172	P20.043	508	P21.003	483
P136.007	262	P15.008	304	P160.651	157	P20.050	508	P21.004	483
P136.008	262	P15.009	304	P160.6BF	169	P20.066	508	P21.005	483
P139.012	56	P15.010	340	P160.6C1	167	P20.069	508	P21.006	483
P140.000	162	P15.014	334	P160.6P1	171	P20.072	437	P21.008	483
P140.001	162	P15.020	334	P161.001	157	P200.012	23	P21.015	483
P140.002	162	P15.027	343	P161.0BF	169	P200.014	23	P21.016	483
P140.004	162	P15.028	343	P161.0C1	167	P200.016	23	P21.017	483
P140.0BF	169	P15.029	336	P161.0P1	171	P200.018	23	P21.020	483
P140.0C1	167	P15.030	336	P161.501	157	P200.020	23	P21.023	483
P140.0C1	171	P15.031	337	P161.5BF	169	P200.022	23	P21.025	483
P140.0P1	162	P15.032	337	P161.5C1	167	P200.024	23	P21.027	483
P140.0P1	167	P15.033	338	P161.5P1	171	P200.028	23	P21.028	483
P140.0P1	169	P15.034	338	P161.5P6	172	P200.116	23	P21.029	483
P140.0P1	170	P15.035	296	P162.001	157	P200.120	23	P210.201	156
P140.0P2	162	P15.036	296	P165.0BF	169	P200.320	24	P210.202	158
P140.0P3	162	P15.038	301	P165.0C1	167	P200.324	24	P210.401	156
P140.0P4	162	P15.039	301	P165.0P1	171	P201.016	23	P210.402	158
P140.0P5	162	P15.040	302	P166.032	61	P201.018	23	P210.651	156
P140.201	157	P15.041	302	P169.020	61	P201.020	23	P210.652	158
P140.651	157	P15.042	300	P169.024	61	P201.024	23	P211.001	156
P140.6BF	169	P15.070	293	P169.028	61	P201.028	23	P211.002	158
P140.6C1	167	P15.071	293	P169.030	61	P201.032	23	P211.501	156
P140.6P1	171	P15.072	288	P170.020	42	P2011-5	189	P211.502	158
P141.001	157	P15.073	340	P170.024	42	P2011-5 F1	189	P2110-5	189
P141.016	41	P15.074	340	P170.028	42	P202.016	23	P2110-5 F1	189
P141.020	41	P15.075	297	P171.024	42	P202.018	23	P212.001	156
P141.024	41	P15.077	288	P171.028	42	P202.020	23	P212.002	158
P141.028	41	P15.078	288	P173.016	42	P202.024	23	P213.018	52
P141.032	41	P15.079	288	P19.100	482	P202.028	23	P213.020	52
P141.036	41	P15.080	295	P19.101	482	P202.032	23	P213.022	52
P141.040	41	P15.089	307	P19.103	482	P203.016	24	P213.024	52
P141.0BF	169	P15.090	307	P19.104	482	P203.018	24	P213.026	52
P141.0C1	167	P15.091	307	P19.105	482	P203.020	24	P213.028	52
P141.0P1	171	P15.096	340	P19.106	482	P203.024	24	P213.032	52
P141.501	157	P15.097	340	P19.107	482	P204.020	24	P213.036	52
P141.5BF	169	P150.028	60	P19.114-A	482	P204.024	24	P213.040	52
P141.5C1	167	P150.128	59	P19.114-N	482	P204.028	24	P214.016	23
P141.5P1	171	P151.012	41	P19.114-R	482	P204.030	24	P214.018	23
P1412-6	189	P151.014	41	P19.115-A	482	P204.032	24	P214.020	23
P1412-6 F1	189	P151.016	41	P19.115-N	482	P204.035	24	P214.022	23
P142.000	60	P151.020	41	P19.115-R	482	P204.040	24	P214.024	23
P142.001	157	P151.024	41	P19.116	482	P205.020	22	P215.000	157
P142.100	59	P151.028	41	P190.000	162	P205.024	22	P215.000	208
P145.000	157	P151.032	41	P190.0BF	169	P205.028	22	P216.016	22
P145.0BF	169	P1510-5	189	P190.0C1	167	P205.030	22	P216.018	22
P145.0C1	167	P1510-5 F1	189	P190.0C1	171	P205.032	22	P216.020	22
P145.0P1	171	P152.025	75	P190.0P1	162	P205.035	22	P216.024	22

ÍNDICE NUMÉRICO / NUMERICAL INDEX /
INDEX NUMÉRIQUE / NUMMERISCHER INDEX

REF.	Pag.	REF.	Pag.	REF.	Pag.	REF.	Pag.	REF.	Pag.
P216.028	22	P22.040	398	P22.165	382	P22.322	370	P22.641N	392
P216.030	22	P22.041	395	P22.166	382	P22.323	370	P22.642B	392
P216.032	22	P22.042	398	P22.167	383	P22.324	370	P22.642N	392
P216.035	22	P22.043	395	P22.168	383	P22.325	370	P22.650	390
P216.040	22	P22.044	398	P22.169	381	P22.326	370	P22.651	390
P216.045	22	P22.045	395	P22.170	381	P22.327	370	P22.652	390
P216.050	22	P22.046	398	P22.171	381	P22.328	370	P22.660	391
P216.060	22	P22.047	395	P22.172	381	P22.329	369	P22.661	391
P217.016	22	P22.048	398	P22.173	381	P22.330	369	P22.662	391
P217.018	22	P22.049	395	P22.174	386	P22.331	369	P22.663	391
P217.020	22	P22.050	398	P22.175	386	P22.332	365	P22.664	391
P217.024	22	P22.051	395	P22.176	386	P22.333	369	P22.690	392
P217.028	22	P22.052	398	P22.177	383	P22.334	369	P22.691	392
P217.030	22	P22.053	395	P22.178	388	P22.335	369	P22.692	392
P217.032	22	P22.054	398	P22.179	388	P22.336	368	P22.695	393
P217.035	22	P22.079	398	P22.180	388	P22.337	368	P22.696	393
P217.040	22	P22.080	395	P22.181	388	P22.338	368	P22.697	393
P217.045	22	P22.081	398	P22.182	387	P22.339	368	P22.698	393
P217.050	22	P22.082	395	P22.183	387	P22.340	368	P22.700	372
P217.060	22	P22.083	398	P22.184	387	P22.341	368	P22.701	372
P218.016	22	P22.084	395	P22.185	403	P22.342	368	P22.702	372
P218.018	22	P22.085	386	P22.200	384	P22.343	368	P22.703	372
P218.020	22	P22.086	386	P22.200A	384	P22.344	367	P22.704	372
P218.024	22	P22.087	398	P22.200AM	384	P22.345	367	P22.705	372
P218.028	22	P22.088	400	P22.200N	384	P22.346	367	P22.710	372
P218.030	22	P22.090	386	P22.200R	384	P22.347	367	P22.711	372
P218.032	22	P22.094	398	P22.200V	384	P22.348	367	P22.712	372
P218.035	22	P22.099	385	P22.201	384	P22.349	380	P22.715	373
P218.040	22	P22.100	383	P22.202	384	P22.350	380	P22.716	373
P218.045	22	P22.101	383	P22.202A	384	P22.351	380	P22.717	373
P218.050	22	P22.102	383	P22.202AM	384	P22.352	380	P22.720	376
P218.060	22	P22.103	382	P22.202N	384	P22.353	380	P22.721	373
P22.000	385	P22.104	400	P22.202R	384	P22.354	379	P22.722	373
P22.001	385	P22.105	400	P22.202V	384	P22.355	379	P22.724	376
P22.002	384	P22.106	400	P22.203	384	P22.356	379	P22.725	376
P22.0021	384	P22.107	400	P22.203A	384	P22.357	379	P22.726	376
P22.0023	384	P22.108	400	P22.203AM	384	P22.358	379	P22.727	376
P22.003	383	P22.109	400	P22.203N	384	P22.359	380	P22.728	376
P22.0031	383	P22.110	400	P22.203R	384	P22.360	380	P22.729	376
P22.0033	383	P22.111	387	P22.203V	384	P22.501	383	P22.730	373
P22.004	385	P22.112	387	P22.204	384	P22.502	383	P22.731	373
P22.005	385	P22.113	387	P22.211	384	P22.600	391	P22.732	373
P22.006	398	P22.114	387	P22.220	383	P22.601	391	P22.733	373
P22.007	398	P22.115	387	P22.221	383	P22.602	391	P22.734	373
P22.008	398	P22.116	387	P22.222	383	P22.603	391	P22.735	373
P22.009	395	P22.117	388	P22.250	388	P22.604	391	P22.740	371
P22.010	395	P22.118	388	P22.251	388	P22.605	391	P22.741	371
P22.011	395	P22.120	402	P22.301	364	P22.606	391	P22.742	371
P22.012	385	P22.124	393	P22.302	364	P22.610B	391	P22.743	371
P22.013	385	P22.125	393	P22.303	364	P22.610N	391	P22.744	371
P22.014	385	P22.126	393	P22.304	364	P22.611B	391	P22.745	371
P22.015	385	P22.127	390	P22.305	364	P22.611N	391	P22.746	371
P22.016	385	P22.128	390	P22.306	364	P22.612B	391	P22.750	371
P22.017	393	P22.129	390	P22.307	364	P22.612N	391	P22.751	371
P22.019	386	P22.144	393	P22.308	364	P22.613B	391	P22.752	371
P22.020	386	P22.145	393	P22.309	364	P22.613N	391	P22.755	371
P22.021	386	P22.150	385	P22.310	366	P22.614B	391	P22.756	371
P22.022	386	P22.151	385	P22.311	366	P22.614N	391	P22.758	376
P22.023	386	P22.154	399	P22.312	366	P22.615B	391	P22.759	376
P22.030	403	P22.155	399	P22.313	366	P22.615N	391	P22.760	371
P22.031	403	P22.156	399	P22.314	366	P22.616B	391	P22.770	372
P22.033	388	P22.157	399	P22.315	366	P22.616N	391	P22.772	372
P22.034	388	P22.158	399	P22.316	366	P22.620	391	P22.775	389
P22.035	403	P22.160	399	P22.317	366	P22.621	391	P22.776	389
P22.036	403	P22.161	392	P22.318	365	P22.622	391	P22.777	389
P22.037	382	P22.162	392	P22.319	365	P22.640B	392	P22.778	389
P22.038	382	P22.163	385	P22.320	365	P22.640N	392	P22.779	389
P22.039	395	P22.164	382	P22.321	365	P22.641B	392	P22.780	375

ÍNDICE NUMÉRICO / NUMERICAL INDEX /
INDEX NUMÉRIQUE / NUMMERISCHER INDEX

REF.	Pag.	REF.	Pag.	REF.	Pag.	REF.	Pag.	REF.	Pag.
P22.781	375	P220.026	50	P230.402	158	P28.502	491	P301.118	82
P22.782	375	P220.028	50	P230.651	156	P28.503	491	P301.165	82
P22.783	375	P220.032	50	P230.652	158	P28.504	491	P301.206	82
P22.784	375	P220.036	50	P231.001	156	P28.505	491	P301.208	82
P22.800	374	P220.040	50	P231.002	158	P28.506	491	P301.210	82
P22.801	374	P220.820	52	P231.501	156	P28.600	490	P301.212	82
P22.802	374	P220.824	52	P231.502	158	P28.610	490	P301.214	82
P22.803	374	P220.828	52	P232.001	156	P28.620	490	P301.216	82
P22.815	374	P220.832	52	P232.002	158	P28.621	490	P302.108	83
P22.816	374	P223.035	26	P234.020	43	P29.600	489	P302.110	83
P22.817	374	P223.040	26	P234.024	43	P29.610	489	P302.112	83
P22.823	374	P224.023	26	P235.000	157	P29.620	489	P302.114	83
P22.824	374	P224.026	26	P239.036	57	P29.630	489	P302.116	83
P22.825	374	P23.003	527	P239.136	57	P290.120	29	P302.118	83
P22.830	377	P23.004	527	P239.236	52	P290.124	29	P302.120	83
P22.833	377	P23.008	527	P239.336	52	P290.128	29	P302.210	83
P22.834	377	P23.009	527	P239.436	57	P290.130	29	P302.212	83
P22.835	377	P23.010	527	P239.536	57	P290.132	29	P302.214	83
P22.838	377	P23.015	527	P24.407	503	P290.135	29	P302.216	83
P22.839	377	P23.030	397	P24.409	503	P290.140	29	P303.016	113
P22.844	377	P23.031	397	P240.040	25	P290.145	29	P303.018	113
P22.845	377	P23.032	397	P240.050	25	P290.150	29	P303.020	113
P22.850	374	P23.033	397	P240.401	156	P291.120	29	P303.022	113
P22.851	374	P23.034	397	P240.651	156	P291.124	29	P303.024	113
P22.852	374	P23.035	397	P241.001	156	P291.128	29	P303.026	113
P22.860	394	P23.036	397	P241.040	25	P291.130	29	P303.200	113
P22.861	394	P23.037	397	P241.050	25	P291.132	29	P303.265	82
P22.862	394	P23.038	397	P241.501	156	P291.135	29	P304.016	243
P22.863	394	P23.039	397	P242.024	25	P291.140	29	P304.018	243
P22.864	394	P23.040	397	P242.028	25	P291.145	29	P304.020	243
P22.865	394	P23.041	397	P242.032	25	P291.150	29	P304.022	243
P22.866	394	P23.042	397	P242.035	25	P291.160	29	P304.024	243
P22.867	394	P23.043	397	P243.024	25	P292.120	29	P306.035	243
P22.868	394	P23.044	397	P243.028	25	P292.124	29	P307.020	243
P22.869	394	P23.045	397	P243.032	25	P292.128	29	P307.025	243
P22.870	394	P23.046	397	P243.035	25	P292.130	29	P307.030	243
P22.871	394	P23.500	486	P244.020	26	P292.132	29	P307.035	243
P22.872	394	P23.501	486	P244.024	26	P292.135	29	P307.040	243
P22.873	394	P23.502	486	P244.028	26	P292.140	29	P307.045	243
P22.874	394	P23.503	486	P244.032	26	P292.145	29	P307.050	243
P22.875	394	P23.504	487	P244.035	26	P292.150	29	P307.060	243
P22.876	394	P23.505	487	P248.028	26	P292.160	29	P307.070	243
P22.877	394	P23.506	487	P248.032	26	P293.132	29	P307.125	243
P22.878	394	P23.507	487	P248.035	26	P293.135	29	P307.130	243
P22.879	394	P23.508	487	P248.040	26	P293.140	29	P307.140	243
P22.880	394	P23.509	487	P248.045	26	P299.020	29	P307.150	243
P22.881	394	P23.800	401	P25.000	507	P299.024	29	P308.030	114
P22.882	394	P23.810	401	P25.002	507	P299.028	29	P308.035	114
P22.883	394	P23.824	401	P25.020	507	P299.030	29	P308.040	114
P22.890	400	P23.825	401	P26.000	147	P299.032	29	P308.045	114
P22.901	378	P23.830	401	P26.001	147	P299.035	29	P308.050	114
P22.902	378	P23.835	401	P26.100	518	P299.040	29	P309.035	68
P22.911	378	P23.836	401	P270.114	36	P299.045	29	P309.040	68
P22.912	378	P23.840	401	P270.116	36	P299.050	29	P309.050	68
P22.920	402	P23.841	401	P270.118	36	P299.060	29	P309.060	68
P22.930	402	P23.842	402	P270.620	36	P300.024	114	P310.000	515
P22.940	378	P23.843	402	P270.624	36	P300.030	114	P311.002	514
P22.950	378	P23.844	402	P270.628	36	P300.325	114	P311.004	515
P22.960	378	P23.845	402	P270.716	36	P300.335	114	P311.006	514
P22.971	378	P23.990	389	P270.720	36	P300.340	114	P311.020	515
P22.972	378	P23.991	389	P270.724	36	P3008-4	189	P311.071	514
P22.973	381	P23.992	389	P270.728	36	P3008-4 F1	189	P312.000	515
P22.974	381	P23.993	389	P28.202	491	P301.108	82	P313.025	115
P22.975	381	P230.000	162	P28.252	491	P301.109	82	P313.030	115
P220.018	50	P230.001	162	P28.302	491	P301.110	82	P313.126	115
P220.020	50	P230.201	156	P28.303	491	P301.112	82	P313.132	115
P220.022	50	P230.202	158	P28.403	491	P301.114	82	P313.500	115
P220.024	50	P230.401	156	P28.501	491	P301.116	82	P314.110	83

ÍNDICE NUMÉRICO / NUMERICAL INDEX /
INDEX NUMÉRIQUE / NUMMERISCHER INDEX

REF.	Pag.	REF.	Pag.	REF.	Pag.	REF.	Pag.	REF.	Pag.
P314.112	83	P328.020	110	P348.008	112	P362.000	473	P396.012	82
P314.210	83	P328.023	110	P348.010	112	P362.100	474	P397.247	85
P314.212	83	P328.600	110	P348.012	112	P363.000	473	P397.347	85
P314.300	83	P33.601	476	P348.015	112	P363.100	474	P398.024	246
P315.010	83	P33.602	476	P348.018	112	P364.000	473	P398.035	246
P315.012	83	P33.603	476	P350.230	252	P364.100	474	P398.042	246
P315.015	83	P33.604	476	P350.235	252	P365.000	473	P398.125	246
P315.017	83	P33.614	476	P350.330	252	P365.100	474	P398.135	246
P315.020	83	P33.621	477	P350.335	252	P366.000	473	P398.140	246
P316.025	245	P33.622	477	P350.426	252	P367.000	473	P398.225	246
P316.030	245	P33.623	477	P350.430	252	P367.100	474	P398.235	246
P316.035	245	P33.624	477	P350.435	252	P368.000	473	P398.240	246
P316.040	245	P33.625	477	P350.440	252	P369.000	473	P398.290	246
P316.045	245	P33.801	478	P350.530	252	P369.100	474	P399.000	517
P316.050	245	P33.802	478	P350.535	252	P372.200	463	P399.400	519
P316.125	245	P33.803	478	P350.630	252	P373.020	112	P399.500	519
P316.130	245	P33.804	478	P350.635	252	P373.024	112	P399.600	519
P316.135	245	P33.805	478	P350.730	252	P373.028	112	P410.020	30
P316.140	245	P33.806	478	P350.735	252	P374.013	112	P410.624	30
P316.145	245	P33.807	478	P351.000	480	P374.015	112	P410.632	30
P316.150	245	P33.808	478	P352.000	480	P374.018	112	P410.724	30
P317.025	470	P33.809	478	P353.000	480	P374.020	112	P410.732	30
P317.030	470	P330.035	516	P354.025	245	P374.026	112	P410.920	30
P317.035	470	P330.050	516	P354.030	245	P375.010	100	P410.924	30
P317.040	470	P330.070	516	P354.035	245	P375.030	112	P410.932	30
P317.045	470	P331.039	239	P354.040	245	P375.035	112	P4407-3	190
P317.050	470	P331.044	239	P354.045	245	P375.061	100	P4407-3 F1	190
P317.425	470	P331.050	239	P354.050	245	P375.070	100	P454.012	35
P317.430	470	P331.056	239	P355.007	262	P375.110	100	P454.014	35
P317.435	470	P331.059	239	P355.008	262	P376.037	84	P454.016	35
P317.440	470	P331.066	239	P356.016	244	P376.137	84	P454.018	35
P317.445	470	P331.070	239	P356.020	244	P377.037	84	P456.016	35
P317.450	470	P332.010	239	P356.024	244	P377.137	85	P456.020	35
P318.005	70	P332.095	239	P356.028	244	P379.065	461	P456.024	35
P318.040	72	P333.010	503	P356.032	244	P379.500	461	P456.028	35
P318.060	72	P333.020	503	P357.000	507	P38.150.250	357	P456.032	35
P318.100	517	P333.035	503	P358.024	94	P38.240.250	355	P457.016	35
P318.211	70	P334.050	120	P358.029	94	P38.250.250	354	P457.020	35
P319.000	517	P334.100	120	P358.040	94	P38.550.250	355	P457.024	35
P319.100	517	P334.200	120	P358.230	479	P380.000	99	P457.028	35
P3208-3	190	P335.002	530	P358.231	479	P381.008	99	P458.024	35
P3208-3 F1	190	P337.030	529	P358.232	479	P381.010	99	P458.028	35
P321.020	114	P337.060	529	P358.237	479	P382.000	99	P459.020	52
P321.022	114	P337.090	529	P358.241	94	P383.000	99	P459.024	52
P321.024	114	P337.150	529	P358.242	94	P384.000	99	P459.028	52
P321.026	114	P337.200	529	P358.243	94	P385.020	99	P460.018	56
P322.101	111	P340.000	542	P358.244	94	P385.026	99	P460.020	56
P322.102	111	P340.010	91	P358.245	94	P385.030	99	P460.022	56
P322.103	111	P340.020	91	P358.246	94	P385.500	100	P460.024	56
P322.104	111	P340.030	91	P358.247	94	P386.000	99	P460.026	56
P322.201	111	P340.040	91	P358.301	94	P387.065	461	P460.028	56
P322.202	111	P340.050	91	P358.302	94	P387.100	463	P460.030	56
P322.203	111	P340.060	91	P358.303	94	P387.200	463	P460.032	56
P322.204	111	P340.070	91	P358.304	94	P387.500	460	P490.014	32
P323.050	120	P340.080	91	P358.305	94	P388.018	517	P490.014A	407
P324.013	112	P340.090	91	P358.306	94	P389.000	481	P490.014G	407
P324.016	112	P341.000	475	P358.307	94	P390.000	135	P490.014N	407
P324.019	112	P342.000	475	P358.401	94	P390.100	135	P490.014R	407
P324.022	112	P343.000	475	P358.402	94	P391.000	110	P490.016	32
P324.025	112	P343.400	93	P358.403	94	P392.065	82	P490.016A	407
P325.008	112	P343.500	93	P358.404	94	P393.080	245	P490.016G	407
P325.010	112	P343.600	93	P358.405	94	P393.100	245	P490.016N	407
P325.012	112	P343.700	93	P358.406	94	P393.125	245	P490.016R	407
P325.015	112	P343.800	93	P358.407	94	P394.008	84	P490.018	32
P325.018	112	P344.000	475	P359.000	480	P394.012	84	P490.020	32
P325.020	112	P345.000	475	P36.790.250	356	P395.038	85	P490.220A	408
P326.000	514	P347.020	113	P361.000	473	P396.009	82	P490.220G	408
P327.000	515	P347.024	113	P361.100	474	P396.010	82	P490.220N	408

ÍNDICE NUMÉRICO / NUMERICAL INDEX /
INDEX NUMÉRIQUE / NUMMERISCHER INDEX

REF.	Pag.	REF.	Pag.	REF.	Pag.	REF.	Pag.	REF.	Pag.
P490.220R	408	P5019	186	P5490 E5	183	P630.020	504	P688.045	336
P490.224A	408	P5062	186	P5490 E5F1	185	P630.030	504	P688.065	287
P490.224G	408	P508.015	338	P5490 F1	184	P630.040	504	P688.085	296
P490.224N	408	P5090	180	P5491	181	P6305-2	190	P688.087	296
P490.224R	408	P5090 E1	182	P5491 F1	184	P6305-2 F1	190	P688.250	337
P490.228A	408	P5090 E1F1	185	P590.001	454	P632.001	504	P688.251	337
P490.228G	408	P5090 E2	182	P590.002	454	P632.002	504	P688.260	337
P490.228N	408	P5090 E2F1	185	P590.003	454	P632.003	504	P688.261	337
P490.228R	408	P5090 E3	182	P590.004	454	P632.004	504	P688.265	336
P490.616	32	P5090 E3F1	185	P590.005	454	P632.005	504	P688.266	336
P490.620	32	P5090 E4	182	P590.006	454	P632.006	504	P688.600	338
P490.620A	407	P5090 E4F1	185	P590.110	455	P632.007	504	P688.620	338
P490.620G	407	P5090 E5	182	P590.120	455	P632.008	504	P7000	226
P490.620N	407	P5090 E5F1	185	P590.130	455	P632.009	504	P7001	226
P490.620R	407	P5090 F1	184	P590.240	455	P632.010	504	P7002	226
P490.624	32	P5091	180	P595.100	449	P632.011	504	P7003	226
P490.624A	407	P5091 F1	184	P595.110	449	P632.012	504	P7004	226
P490.624G	407	P5160	180	P595.111	449	P632.013	504	P7004R	225
P490.624N	407	P5160 E1	182	P595.120	449	P632.014	504	P7005	226
P490.624R	407	P5160 E1F1	185	P595.121	449	P632.015	504	P7005R	225
P490.628	32	P5160 E2	182	P595.130	449	P632.016	504	P7006	226
P490.628A	407	P5160 E2F1	185	P595.131	449	P632.017	504	P7006R	225
P490.628G	407	P5160 E3	182	P595.200	449	P632.018	504	P7007	226
P490.628N	407	P5160 E3F1	185	P595.300	449	P632.019	504	P7008	226
P490.628R	407	P5160 E4	182	P596.110	452	P632.020	504	P7009	226
P490.632A	407	P5160 E4F1	185	P596.111	452	P632.021	504	P7010	226
P490.632G	407	P5160 E5	182	P596.120	452	P632.022	504	P7011	226
P490.632N	407	P5160 E5F1	185	P596.121	452	P632.023	504	P7012	226
P490.632R	407	P5160 F1	184	P596.130	452	P632.024	504	P7013	226
P490.716	32	P5161	180	P596.131	452	P632.025	504	P7014	226
P490.720	32	P5161 F1	184	P597.110	450	P632.026	504	P7015	226
P490.724	32	P5250	180	P597.120	450	P632.027	504	P7016	226
P490.724A	407	P5250 E1	182	P597.130	450	P632.028	504	P7017	226
P490.724G	407	P5250 E1F1	185	P597.140	451	P632.029	504	P7018	226
P490.724N	407	P5250 E2	182	P597.150	451	P632.030	504	P7019	226
P490.724R	407	P5250 E2F1	185	P597.160	451	P633.000	504	P702.026	255
P490.728	32	P5250 E3	182	P597.170	450	P633.002	504	P702.028	255
P490.728A	407	P5250 E3F1	185	P598.700	455	P633.003	504	P702.230	255
P490.728G	407	P5250 E4	182	P598.800	455	P634.000	504	P7020	226
P490.728N	407	P5250 E4F1	185	P600.005	142	P635.000	508	P7021	226
P490.728R	407	P5250 E5	182	P602.015	142	P636.000	508	P7022	226
P490.732	32	P5250 E5F1	185	P603.012	145	P637.000	508	P7023	226
P490.732A	407	P5250 F1	184	P603.015	145	P637.100	508	P7024	226
P490.732G	407	P5251	180	P604.001	145	P638.000	506	P7025	226
P490.732N	407	P5251 F1	184	P604.002	145	P639.000	506	P7026	226
P490.732R	407	P5360	181	P604.500	145	P640.000	200	P7027	226
P490.928A	407	P5360 E1	183	P605.000	480	P641.100	200	P7028	226
P490.928G	407	P5360 E1F1	185	P606.000	480	P642.000	200	P7029	226
P490.928N	407	P5360 E2	183	P607.000	78	P643.000	200	P703.020	256
P490.928R	407	P5360 E2F1	185	P609.010	142	P644.100	531	P703.024	256
P490.932A	407	P5360 E3	183	P609.200	142	P644.175	531	P703.028	256
P490.932G	407	P5360 E3F1	185	P609.705	143	P644.200	531	P703.032	256
P490.932N	407	P5360 E4	183	P610.000	135	P644.240	531	P7030	226
P490.932R	407	P5360 E4F1	185	P611.000	143	P644.275	531	P7031	226
P5000	186	P5360 E5	183	P611.001	97	P646.000	513	P7032	226
P5001	186	P5360 E5F1	185	P615.000	481	P646.100	531	P7033	226
P5002	186	P5360 F1	184	P615.100	481	P646.103	531	P7034	226
P5003	186	P5361	181	P616.000	517	P646.105	531	P7035	226
P5004	186	P5361 F1	184	P617.017	480	P646.200	531	P7036	226
P501 F1	177	P5490	181	P618.000	481	P646.300	531	P7037	226
P501 F2	177	P5490 E1	183	P619.000	522	P646.301	531	P7038	226
P501 F3	177	P5490 E1F1	185	P619.002	522	P646.310	531	P7039	226
P501 F4	177	P5490 E2	183	P620.001	97	P646.400	530	P704.024	255
P501 F5	177	P5490 E2F1	185	P621.000	97	P649.050	530	P704.030	255
P501 F6	177	P5490 E3	183	P621.001	97	P649.100	530	P7040	226
P5015	212	P5490 E3F1	185	P623.003	503	P650.000	506	P7041	226
P5017	212	P5490 E4	183	P625.000	504	P685.004	463	P7042	226
P5018	186	P5490 E4F1	185	P630.010	504	P688.010	295	P7043	226

ÍNDICE NUMÉRICO / NUMERICAL INDEX /
INDEX NUMÉRIQUE / NUMMERISCHER INDEX

REF.	Pag.	REF.	Pag.	REF.	Pag.	REF.	Pag.	REF.	Pag.
P7044	226	P710.205	338	P7154	226	P721.005	258	P7270	230
P7045	226	P710.206	338	P7155	226	P721.006	258	P7271	230
P7046	226	P7100	230	P7156	226	P721.007	258	P7272	230
P7047	228	P7101	230	P7157	226	P721.008	258	P7273	230
P7048	228	P7102	230	P7158	226	P721.010	258	P7274	230
P7049	228	P7103	230	P7159	226	P7210	228	P7275	230
P705.024	77	P7104	230	P7160	226	P7211	228	P7276	230
P705.028	77	P7105	230	P7161	226	P7212	228	P7277	230
P705.032	77	P7106	230	P7162	226	P7213	228	P7278	230
P7050	228	P7107	230	P7163	226	P7214	228	P7279	230
P7051	228	P7108	230	P7164	226	P7215	228	P7280	230
P7052	228	P7109	230	P7165	226	P7216	228	P7281	230
P7053	228	P711.010	256	P7166	226	P7217	228	P7282	227
P7054	228	P711.012	256	P7167	226	P7218	228	P7283	227
P7055	228	P711.020	256	P7168	226	P7219	228	P7284	227
P7056	228	P711.024	256	P7169	226	P722.000	258	P7285	227
P7057	228	P711.028	256	P717.008	258	P7220	228	P7286	227
P7058	228	P711.032	256	P717.010	258	P7221	228	P7287	227
P7059	228	P7110	230	P7170	226	P7222	228	P7288	227
P706.039	255	P7111	230	P7171	226	P7223	228	P7289	227
P7060	228	P7112	230	P7172	226	P7224	228	P7290	227
P7061	228	P7113	230	P7173	226	P7225	228	P7291	227
P7062	228	P7114	230	P7174	226	P7226	228	P7292	227
P7063	228	P7115	230	P7175	226	P7227	228	P7293	227
P7064	228	P7116	230	P7176	226	P7228	228	P7294	227
P7065	228	P7117	230	P7177	226	P7229	228	P7295	227
P7066	228	P7118	230	P7178	226	P723.024	256	P7296	227
P7067	228	P7119	230	P7179	226	P723.028	256	P7297	227
P7068	228	P712.022	257	P718.006	258	P7230	228	P7298	227
P7069	228	P7120	230	P718.008	258	P7231	228	P7299	227
P707.039	255	P7121	230	P718.010	258	P7232	228	P7300	227
P7070	228	P7122	230	P718.011	258	P7233	228	P7301	227
P7071	228	P7123	230	P7180	226	P7234	228	P7302	227
P7072	228	P7124	230	P7181	226	P7235	230	P7303	227
P7073	228	P7125	230	P7182	226	P7236	230	P7304	227
P7074	228	P7126	230	P7183	226	P7237	230	P7305	227
P7075	228	P7127	230	P7184	226	P7238	230	P7306	227
P7076	228	P7128	230	P7185	226	P7239	230	P7307	227
P7077	228	P7129	230	P7186	226	P7240	230	P7308	227
P7078	228	P713.075	257	P7187	226	P7241	230	P7309	227
P7079	228	P7130	230	P7188	228	P7242	230	P7310	227
P708.008	257	P7131	230	P7189	228	P7243	230	P7311	227
P708.022	257	P7132	230	P7190	228	P7244	230	P7312	227
P708.024	257	P7133	230	P7191	228	P7245	230	P7313	227
P7080	228	P7134	230	P7192	228	P7246	230	P7314	227
P7081	228	P7135	230	P7193	228	P7247	230	P7315	227
P7082	228	P7136	230	P7194	228	P7248	230	P7316	227
P7083	228	P7137	230	P7195	228	P7249	230	P7317	227
P7084	228	P7138	230	P7196	228	P7250	230	P7318	227
P7085	228	P7139	230	P7197	228	P7251	230	P7319	227
P7086	228	P7140	230	P7198	228	P7252	230	P732.000	259
P7087	228	P7141	226	P7199	228	P7253	230	P7320	227
P7088	228	P7142	226	P720.005	258	P7254	230	P7321	227
P7089	228	P7143	226	P720.006	258	P7255	230	P7322	227
P709.035	255	P7144	226	P720.007	258	P7256	230	P7323	227
P7090	228	P7145	226	P720.008	258	P7257	230	P7324	227
P7091	228	P7145R	225	P720.010	258	P7258	230	P7325	227
P7092	228	P7146	226	P720.012	258	P7259	230	P7326	227
P7093	228	P7146R	225	P7200	228	P7260	230	P7327	227
P7094	230	P7147	226	P7201	228	P7261	230	P7328	227
P7095	230	P7147R	225	P7202	228	P7262	230	P7329	229
P7096	230	P7148	226	P7203	228	P7263	230	P733.000	259
P7097	230	P7149	226	P7204	228	P7264	230	P7330	229
P7098	230	P715.006	257	P7205	228	P7265	230	P7331	229
P7099	230	P7150	226	P7206	228	P7266	230	P7332	229
P710.020	256	P7151	226	P7207	228	P7267	230	P7333	229
P710.024	256	P7152	226	P7208	228	P7268	230	P7334	229
P710.028	256	P7153	226	P7209	228	P7269	230	P7335	229

ÍNDICE NUMÉRICO / NUMERICAL INDEX /
INDEX NUMÉRIQUE / NUMMERISCHER INDEX

REF.	Pag.	REF.	Pag.	REF.	Pag.	REF.	Pag.	REF.	Pag.
P7336	229	P7402	231	P7470	229	P7538	231	P7609	225
P7337	229	P7403	231	P7471	229	P7539	231	P7610	225
P7338	229	P7404	231	P7472	229	P7540	231	P7611	225
P7339	229	P7405	231	P7473	229	P7541	231	P7612	225
P7340	229	P7406	231	P7474	229	P7542	231	P7613	225
P7341	229	P7407	231	P7475	229	P7543	231	P7614	225
P7342	229	P7408	231	P7476	229	P7544	231	P7615	225
P7343	229	P7409	231	P7477	229	P7545	231	P7616	225
P7344	229	P7410	231	P7478	229	P7546	231	P7617	225
P7345	229	P7411	231	P7479	229	P7547	231	P7618	225
P7346	229	P7412	231	P7480	229	P7548	231	P7628	224
P7347	229	P7413	231	P7481	229	P7549	231	P7629	224
P7348	229	P7414	231	P7482	229	P7550	231	P7630	224
P7349	229	P7415	231	P7483	229	P7551	231	P7631	224
P7350	229	P7416	231	P7484	229	P7552	231	P7632	224
P7351	229	P7417	231	P7485	229	P7553	231	P7633	224
P7352	229	P7418	231	P7486	229	P7554	231	P7634	224
P7353	229	P7419	231	P7487	229	P7555	231	P7635	224
P7354	229	P7420	231	P7488	229	P7556	231	P7636	224
P7355	229	P7421	231	P7489	229	P7557	231	P7637	224
P7356	229	P7422	231	P7490	229	P7558	231	P7638	224
P7357	229	P7423	227	P7491	229	P7559	231	P7639	224
P7358	229	P7424	227	P7492	229	P7560	231	P764.008	244
P7359	229	P7425	227	P7493	229	P7561	231	P764.010	244
P736.030	77	P7426	227	P7494	229	P7562	231	P764.012	244
P736.034	77	P7427	227	P7495	229	P7563	231	P764.014	244
P7360	229	P7428	227	P7496	229	P7565	222	P7640	224
P7361	229	P7429	227	P7497	229	P7566	222	P7641	224
P7362	229	P7430	227	P7498	229	P7567	222	P7642	224
P7363	229	P7431	227	P7499	229	P7568	222	P7643	224
P7364	229	P7432	227	P7500	229	P7569	222	P7646	223
P7365	229	P7433	227	P7501	229	P7570	222	P7647	223
P7366	229	P7434	227	P7502	229	P7571	222	P765.020	261
P7367	229	P7435	227	P7503	229	P7572	222	P765.024	261
P7368	229	P7436	227	P7504	229	P7573	222	P768.006	261
P7369	229	P7437	227	P7505	229	P7574	222	P768.008	261
P7370	229	P7438	227	P7506	229	P7575	222	P769.008	261
P7371	229	P7439	227	P7507	229	P7576	222	P769.010	261
P7372	229	P7440	227	P7508	229	P7577	222	P769.018	261
P7373	229	P7441	227	P7509	229	P7578	222	P769.020	261
P7374	229	P7442	227	P7510	229	P7579	222	P769.022	261
P7375	229	P7443	227	P7511	229	P7580	222	P771.025	261
P7376	231	P7444	227	P7512	229	P7581	222	P777.540	72
P7377	231	P7445	227	P7513	229	P7582	222	P777.548	72
P7378	231	P7446	227	P7514	229	P7583	222	P777.560	72
P7379	231	P7447	227	P7515	229	P7584	222	P778.040	72
P7380	231	P7448	227	P7516	229	P7585	223	P778.048	72
P7381	231	P7449	227	P7517	231	P7586	223	P778.060	72
P7382	231	P7450	227	P7518	231	P7587	223	P779.017	72
P7383	231	P7451	227	P7519	231	P7588	223	P779.021	72
P7384	231	P7452	227	P7520	231	P7589	223	P779.026	72
P7385	231	P7453	227	P7521	231	P7590	223	P779.060	72
P7386	231	P7454	227	P7522	231	P7591	223	P780.006	260
P7387	231	P7455	227	P7523	231	P7592	223	P780.008	260
P7388	231	P7456	227	P7524	231	P7593	223	P780.010	260
P7389	231	P7457	227	P7525	231	P7594	223	P781.006	260
P7390	231	P7458	227	P7526	231	P7595	223	P781.008	260
P7391	231	P7459	227	P7527	231	P7596	223	P781.010	260
P7392	231	P7460	227	P7528	231	P7597	223	P782.008	260
P7393	231	P7461	227	P7529	231	P7598	223	P782.010	260
P7394	231	P7462	227	P7530	231	P7599	223	P782.012	260
P7395	231	P7463	227	P7531	231	P76.430	224	P782.014	260
P7396	231	P7464	227	P7532	231	P7603	225	P782.016	260
P7397	231	P7465	227	P7533	231	P7604	225	P782.018	260
P7398	231	P7466	227	P7534	231	P7605	225	P782.020	260
P7399	231	P7467	227	P7535	231	P7606	225	P782.022	260
P7400	231	P7468	227	P7536	231	P7607	225	P782.024	260
P7401	231	P7469	227	P7537	231	P7608	225	P782.026	260

ÍNDICE NUMÉRICO / NUMERICAL INDEX /
INDEX NUMÉRIQUE / NUMMERISCHER INDEX

REF.	Pag.	REF.	Pag.	REF.	Pag.	REF.	Pag.	REF.	Pag.
P782.028	260	P80.610	211	P812.007	265	P850.007	270	P859.141	275
P782.075	260	P80.620	211	P812.009	265	P850.012	270	P859.142	275
P783.006	260	P80.630	211	P812.011	265	P850.017	270	P859.143	276
P783.008	260	P80.640	211	P813.016	265	P850.018	270	P859.144	276
P783.010	260	P80.670	204	P813.020	265	P850.022	270	P859.150	276
P783.012	260	P80.680	203	P813.028	265	P850.023	270	P859.151	276
P783.014	260	P80.700	542	P814.000	266	P850.024	270	P859.152	276
P783.016	260	P80.710	542	P815.004	266	P850.025	270	P859.153	276
P783.018	260	P80.720	542	P815.006	266	P850.026	270	P859.154	277
P783.020	260	P80.730	542	P815.009	266	P850.027	270	P859.155	277
P783.022	260	P80.740	210	P815.012	266	P850.028	270	P859.156	277
P783.024	260	P80.740	541	P815.015	266	P850.031	270	P859.157	277
P783.026	260	P80.750	212	P815.018	266	P850.033	270	P859.158	277
P783.028	260	P80.760	212	P816.011	265	P850.124	271	P859.159	277
P783.030	260	P80.770	212	P816.013	265	P850.128	271	P859.167	277
P784.020	262	P80.780	211	P816.015	265	P850.222	271	P859.169	277
P784.025	262	P80.810	208	P817.005	265	P850.424	271	P859.171	278
P784.030	262	P80.811	208	P817.006	265	P850.426	271	P859.172	278
P784.035	262	P80.813	208	P817.008	265	P850.528	271	P859.174	280
P784.040	262	P80.814	208	P818.000	120	P850.614	271	P859.179	281
P785.006	260	P80.840	207	P820.000	266	P851.040	263	P859.183	278
P785.008	260	P80.850	207	P821.000	266	P851.046	263	P859.184	278
P785.010	260	P80.870	207	P822.000	267	P851.050	263	P859.185	278
P788.025	262	P80.880	207	P823.000	267	P853.004	268	P859.186	278
P788.050	262	P80.900	200	P824.000	267	P853.006	268	P859.189	278
P789.025	262	P80.910	209	P830.001	253	P853.008	268	P859.190	278
P789.050	262	P80.940	203	P830.002	253	P853.010	268	P859.191	278
P796.000	259	P80.941	203	P830.003	253	P853.012	268	P859.192	279
P796.100	259	P80.950	209	P830.004	253	P853.014	268	P859.195	279
P798.040	264	P80.951	209	P830.005	253	P854.006	268	P859.196	279
P798.055	264	P80.960	202	P833.001	78	P854.008	268	P859.197	279
P798.056	264	P80.961	202	P833.002	78	P854.010	268	P859.198	279
P798.065	264	P80.970	205	P833.003	78	P854.012	268	P859.200	280
P80.210	446	P800.030	263	P834.000	455	P854.014	268	P859.201	280
P80.216	446	P800.035	263	P835.000	455	P854.016	268	P859.202	280
P80.219	446	P800.040	263	P836.110	249	P855.000	268	P859.203	281
P80.220	446	P800.045	263	P836.120	249	P856.000	268	P859.204	281
P80.240	201	P800.050	263	P836.147	249	P857.000	268	P859.205	281
P80.250	201	P800.055	263	P836.200	249	P859.101	276	P859.206	279
P80.260	201	P800.060	263	P836.215	249	P859.102	276	P859.207	279
P80.270	201	P800.065	263	P837.003	252	P859.103	276	P859.210	280
P80.280	201	P800.070	263	P837.005	252	P859.104	276	P859.211	280
P80.290	201	P801.040	248	P837.007	252	P859.105	276	P859.212	280
P80.300	201	P801.048	248	P837.300	252	P859.106	279	P859.219	277
P80.310	201	P802.000	248	P839.000	247	P859.107	279	P859.900	272
P80.320	201	P803.000	248	P840.000	247	P859.109	276	P859.901	272
P80.330	202	P804.000	248	P842.000	247	P859.110	276	P859.902	272
P80.340	202	P805.000	247	P845.040	248	P859.111	276	P859.903	272
P80.350	202	P807.000	247	P845.050	248	P859.112	281	P859.904	272
P80.360	202	P81.000	342	P845.060	248	P859.113	275	P859.905	272
P80.374	203	P81.010	342	P845.075	248	P859.114	278	P859.906	273
P80.380	210	P81.020	342	P845.110	248	P859.115	275	P859.907	273
P80.390	210	P810.004	265	P845.138	248	P859.116	280	P859.908	273
P80.430	204	P810.006	265	P845.155	248	P859.117	279	P859.909	273
P80.440	206	P810.008	265	P846.025	145	P859.119	281	P859.910	273
P80.460	207	P810.010	265	P846.050	145	P859.120	281	P859.911	273
P80.470	205	P810.012	265	P846.100	145	P859.121	281	P861.045	541
P80.480	206	P810.014	265	P846.200	145	P859.122	277	P861.053	541
P80.500	207	P811.004	265	P846.300	145	P859.123	277	P862.100	505
P80.510	206	P811.006	265	P848.008	249	P859.124	277	P863.000	505
P80.520	205	P811.008	265	P848.014	249	P859.125	278	P867.030	400
P80.530	207	P811.010	265	P849.000	264	P859.126	278	P867.060	400
P80.540	211	P811.012	265	P850.001	270	P859.129	279	P867.090	400
P80.550	211	P811.014	265	P850.002	270	P859.130	277	P867.120	400
P80.560	211	P811.016	265	P850.003	270	P859.132	275	P868.001	117
P80.570	211	P811.018	265	P850.004	270	P859.134	275	P868.002	117
P80.580	212	P812.003	265	P850.005	270	P859.135	275	P868.003	117
P80.590	212	P812.005	265	P850.006	270	P859.139	275	P868.004	117

ÍNDICE NUMÉRICO / NUMERICAL INDEX /
INDEX NUMÉRIQUE / NUMMERISCHER INDEX

REF.	Pag.	REF.	Pag.	REF.	Pag.	REF.	Pag.	REF.	Pag.
P868.005	117	P894.528	411	P904.611	438	P911.302	139	P924.002	545
P868.006	117	P894.528A	409	P904.612	438	P911.303	139	P924.002A	545
P868.007	117	P894.528G	409	P904.613	438	P911.304	139	P924.002R	545
P868.008	117	P894.528N	409	P904.650	438	P911.305	139	P924.002V	545
P868.009	117	P894.528R	409	P904.651	438	P911.306	139	P925.001	209
P870.000	119	P894.532	411	P904.652	438	P911.401	139	P925.002	209
P871.000	119	P894.532A	409	P904.653	438	P911.402	139	P926.002	501
P872.000	100	P894.532G	409	P904.660	438	P911.403	139	P926.003	501
P872.500	249	P894.532N	409	P904.661	438	P911.404	139	P926.004	501
P873.045	120	P894.532R	409	P904.680	438	P911.405	139	P926.005	501
P873.060	120	P894.632	411	P904.681	438	P911.406	139	P926.006	501
P873.090	120	P894.632A	409	P904.682	438	P911.407	140	P926.007	501
P874.000	505	P894.632G	409	P904.683	438	P911.408	139	P926.008	501
P875.003	239	P894.632N	409	P904.711	436	P911.501	140	P926.009	501
P875.004	239	P894.632R	409	P904.720	437	P911.502	140	P926.010	501
P880.020	526	P895.006	529	P904.721	443	P911.503	140	P926.011	501
P880.035	526	P895.010	529	P904.725	437	P911.504	140	P926.012	501
P880.050	526	P895.015	529	P904.740	436	P911.505	140	P926.051	500
P881.100	526	P895.020	529	P904.760	436	P911.506	140	P926.052	500
P881.175	526	P896.001	528	P904.780	436	P911.507	140	P926.053	500
P882.015	526	P896.002	528	P904.790	434	P911.508	140	P927.000	471
P882.035	526	P896.003	527	P904.800	434	P911.601	140	P928.000	471
P882.050	526	P896.008	527	P904.801	443	P911.602	140	P928.001	471
P882.100	526	P896.500	527	P904.804	443	P911.603	140	P929.025	77
P885.025	526	P897.500	460	P904.806	443	P911.604	140	P929.028	77
P885.040	526	P898.001	528	P904.807	443	P911.605	140	P929.030	77
P885.060	526	P898.002	528	P904.809	443	P911.606	140	P929.036	77
P886.035	526	P899.200	464	P904.810	437	P911.607	140	P929.040	77
P886.060	526	P899.202	464	P904.820	437	P911.608	140	P937.000	131
P887.015	526	P899.300	464	P904.850	437	P911.701	139	P938.000	135
P887.025	526	P899.302	464	P904.890	437	P911.801	139	P94.500.250	358
P887.035	526	P90.490	444	P904.937	439	P911.802	139	P940.000	120
P887.060	526	P90.492	444	P904.950	439	P911.803	139	P940.090	120
P887.100	526	P90.492	445	P904.975	439	P911.804	139	P940.120	120
P890.025	525	P90.493	444	P904.980	439	P911.805	139	P941.013	84
P890.035	525	P90.493	445	P904.990	439	P911.806	139	P941.015	84
P890.060	525	P90.495	445	P905.015	119	P911.808	139	P941.018	84
P890.125	525	P90.813	447	P905.200	433	P911.901	140	P941.020	84
P891.035	525	P90.8132	447	P905.300	432	P911.902	140	P941.022	84
P891.060	525	P90.814	447	P905.310	432	P911.903	140	P941.024	84
P891.100	525	P90.8142	447	P905.320	433	P911.904	140	P941.028	84
P891.150	525	P900.000	542	P905.340	433	P911.905	140	P942.000	119
P892.015	525	P901.014	140	P905.400	431	P911.906	140	P943.000	119
P892.015B	524	P901.018	140	P905.410	432	P911.908	140	P944.000	120
P892.015N	524	P902.000	481	P905.504	430	P912.001	139	P945.037	115
P892.015R	524	P903.001	471	P905.506	430	P913.000	140	P945.050	115
P892.025	525	P903.002	471	P905.508	431	P913.501	140	P945.051	115
P892.035	525	P904.100	442	P905.516	430	P913.601	140	P946.001	118
P892.035B	524	P904.113	440	P905.518	431	P913.701	140	P946.002	118
P892.035N	524	P904.120	440	P907.024	471	P913.901	140	P946.003	118
P892.035R	524	P904.120W	440	P907.026	471	P914.080	240	P946.004	118
P892.060	525	P904.140	441	P908.000	239	P914.120	240	P947.301	146
P892.060B	524	P904.142	442	P908.001	239	P914.150	240	P947.302	146
P892.060N	524	P904.145	441	P908.002	239	P915.080	240	P947.303	146
P892.060R	524	P904.146	443	P908.003	239	P916.000	240	P947.400	146
P892.100	525	P904.155	437	P908.004	239	P916.120	240	P947.600	146
P892.150	525	P904.157	437	P909.111	74	P917.080	240	P947.700	146
P892.200	525	P904.160	441	P909.121	74	P918.000	240	P948.066	78
P893.025	525	P904.165	440	P909.211	74	P919.000	544	P948.090	78
P893.035	525	P904.200	442	P909.221	74	P920.001	544	P948.132	78
P894.003	529	P904.300	455	P909.340	74	P920.002	544	P948.163	78
P894.004	529	P904.350	435	P909.360	74	P920.003	544	P949.025	77
P894.005	529	P904.360	435	P909.460	74	P921.001	544	P949.030	77
P894.524	411	P904.400	442	P909.559	254	P922.000	544	P949.035	77
P894.524A	409	P904.500	442	P910.008	334	P922.100	544	P949.040	77
P894.524G	409	P904.600	438	P911.201	139	P923.000	544	P950.000	340
P894.524N	409	P904.601	438	P911.202	139	P923.001	544	P951.010	244
P894.524R	409	P904.610	438	P911.301	139	P924.001	545	P951.015	244

ÍNDICE NUMÉRICO / NUMERICAL INDEX /
INDEX NUMÉRIQUE / NUMMERISCHER INDEX

REF.	Pag.	REF.	Pag.	REF.	Pag.	REF.	Pag.
P951.019	244	P977.015	78	P998.070	65	VDBM300	550
P951.024	244	P979.000	251	P999.000	65	VPB316	550
P952.001	244	P979.100	251	PLC-1	538	VPB318	550
P952.002	244	P979.200	251	PLC-2	538	VPB51602	550
P952.003	244	P980.000	143	PLC-3	538	VPB51802	550
P953.001	244	P980.050	143	RE 937.001	131	VPB5P1802	550
P953.002	244	P980.200	143	RE 937.002	131	VTB300	551
P953.003	244	P980.400	145	RE 937.003	131	VTB50002	551
P953.004	244	P981.400	144	RE 940.001	120	VTB5P0002	551
P953.005	244	P981.500	144	RE 964.100	135	WCT708E	302
P954.013	115	P981.600	144	RE 964.200	135	WKS800E	322
P954.015	115	P981.650	144	RE 975.001	127	WMO90E	295
P954.020	115	P983.000	521	RE 975.002	127	WSB2W	310
P954.025	115	P984.100	521	RE 975.901	133	WSB33XE	310
P955.010	84	P984.500	521	RSCL-4	538	WSB40E	310
P955.012	84	P985.000	520	S1	536	WSB50ST	309
P955.015	84	P988.100	513	SAC-SQ5-06	214	WSB55ST	309
P955.017	84	P988.200	513	SAVC	214	WSB60ST	309
P955.020	84	P988.300	513	SBC1014-2F-06	454	WSB65ST	309
P956.035	522	P988.400	512	SE1000	320	WSB70ST	309
P956.040	522	P988.500	512	SE500	320	WSBPPCE	309
P956.135	522	P988.600	512	SF144X-302I2	350	WW180E	297
P956.140	522	P988.700	512	SO2-23010.5	299	WW200E	297
P958.010	115	P988.800	513	SO2-23014.5	299	WWCM180E	297
P958.012	115	P988.900	513	T3660	464	XMIX0702	306
P958.014	115	P99.00.000	358	T7206	238	XMIX0703	306
P958.016	115	P990.000	513	TBB145E	317	XMIX0704	306
P958.018	115	P991.010	251	TBB160E	317	XMIX0705	306
P959.025	245	P992.040	261	TR11	180		
P959.030	245	P992.045	261	TR11 G	182		
P959.035	245	P992.050	261	TR11 GG	182		
P959.040	245	P994.020	64	TR11 GGG	182		
P959.045	245	P994.022	64	TR11 GGGG	182		
P959.050	245	P994.024	64	TR11 GGGGG	182		
P960.225	246	P994.026	64	TR12	181		
P960.230	246	P994.030	64	TR12 H	183		
P960.235	246	P994.032	64	TR12 HH	183		
P962.002	463	P994.034	64	TR12 HHH	183		
P962.003	463	P994.036	64	TR12 HHHH	183		
P963.025	77	P994.038	64	TR12 HHHHH	183		
P963.030	77	P994.040	64	TR13	181		
P963.035	77	P994.042	64	TR13 M	183		
P963.040	77	P994.046	64	TR13 MM	183		
P964.001	135	P994.050	64	TR13 MMM	183		
P967.001	502	P994.055	64	TR13 MMMM	183		
P967.002	502	P994.065	64	TR18	180		
P967.003	502	P994.080	64	TR18 J	182		
P967.004	502	P994.090	64	TR18 JJ	182		
P967.005	502	P995.010	64	TR18 JJJ	182		
P967.006	502	P995.016	64	TR18 JJJJ	182		
P967.007	502	P995.020	64	TR18 JJJJJ	182		
P967.008	502	P995.026	64	TR21	190		
P967.009	502	P995.030	64	TR22	190		
P968.000	505	P995.034	64	TR23	190		
P968.125	505	P995.036	64	TR30	190		
P968.130	505	P995.038	64	TR33	186		
P968.135	505	P995.040	64	TRG	180		
P969.000	505	P995.042	64	TRH	181		
P970.000	113	P995.050	64	TRJ	180		
P972.053	78	P995.060	64	TRM	181		
P972.060	78	P997.014	64	VCBL300	550		
P974.000	515	P997.016	64	VCBL50002	550		
P975.000	127	P997.028	64	VCBL5P0002	550		
P975.500	136	P997.032	64	VCBM300	550		
P975.600	136	P997.036	64	VCBM50002	550		
P975.900	133	P997.040	64	VDBBM300	551		
P976.200	514	P998.035	65	VDBBM50002	551		
P976.300	514	P998.050	65	VDBBM5P0002	551		

1. Disposiciones legales

Todas las ventas realizadas por PUJADAS – Una compañía del grupo Vollrath (en adelante, “el vendedor”) están sujetas a los presentes términos y condiciones, y están expresamente condicionadas por la aceptación de los presentes términos y condiciones. Ningún otro término o condición adicional o diferente será vinculante para el vendedor a menos que se acuerde lo contrario específicamente por escrito. Por el presente el vendedor no acepta otros términos adicionales o diferentes y notifica al comprador que no está dispuesto a vender en virtud de términos diferentes de los presentes términos y condiciones. **Cada contrato de venta, incluyendo los presentes términos y condiciones, constituirá el acuerdo indivisible entre el vendedor y el comprador, y se regirá, interpretará y entenderá según las leyes de España, sin remisión a los Principios sobre Conflictos de Leyes. Los derechos y las obligaciones de las partes en virtud del presente no se regirán por la Convención de las Naciones Unidas sobre los Contratos de Compraventa Internacional de Mercaderías de 1980; y por el presente ambas partes se someten expresamente a la jurisdicción de los tribunales de Barcelona (España), para cualquier proceso judicial que surja de las presentes condiciones generales de venta o relacionado con estas.** No existe ninguna condición que afecte al acuerdo de las partes que no esté expresada en los presentes términos y condiciones.

2. Impuestos y otros cargos

Los impuestos del fabricante, impuesto por ocupación, impuesto por el uso, impuesto sobre las ventas, impuesto sobre consumos específicos, impuesto sobre el valor añadido, tasas, tarifas de personalización, inspección o prueba, o cualquier otro impuesto, tasa, interés o cargo de cualquier naturaleza impuesto por una autoridad gubernamental, en virtud de la transacción entre el comprador y el vendedor serán pagados por el comprador, además de los precios cotizados o facturados. Si el vendedor debiera pagar dichos impuestos u otros cargos, el comprador deberá reembolsarlos al vendedor.

3. Entrega y flete

Todos los productos se entregarán bajo FCA punto de origen (Incoterms 2010). Con la excepción de lo establecido a continuación, los pedidos realizados desde la zona de la Península Ibérica y las Islas Baleares con un valor superior a 500 € (1.400 € en las Islas Canarias) con envío a un sitio se enviarán PREPAGADOS por el vendedor. Los pedidos con un valor inferior a 500 € se grabarán con un cargo por flete de 20 € (55 € en las Islas Canarias). Para destinos finales fuera de España, todos los productos estarán sujetos a FCA muelle de carga del vendedor (según la definición de este último en Incoterms 2010). La entrega de los productos al transportista se considerará entrega al comprador; e independientemente de los términos de envío o el pago del flete, el comprador asumirá todos los riesgos por pérdida o daño durante el transporte. El vendedor se reserva el derecho a hacer la entrega en múltiples envíos, a menos que se estipule lo contrario expresamente en el presente; dichos envíos se facturarán por separado y se pagarán en la fecha que indica cada factura, independientemente de las entregas posteriores. El vendedor se reserva los derechos de propiedad de todos los materiales enviados hasta el pago completo de estos.

a. Gestión por pedido mínimo

Se aplicará un cargo de 6 € por la gestión de pedidos inferiores a 100 € NETOS. El vendedor se reserva el derecho a no aceptar pedidos de envío directo para los mismos productos a uno o múltiples sitios.

b. Cantidad

Los materiales se enviarán con el embalaje completo que contenga la cantidad indicada en nuestras tarifas.

c. Utensilios de cocina a medida

Los pedidos de utensilios de cocina a medida se ejecutan con entregas parciales/sobreenvíos, sin que la diferencia suponga un 10% más o menos de la cantidad original pedida.

d. Pedidos Urgentes para todo territorio nacional, incluyendo islas Baleares y Canarias

1. Pedido inferiores a 5 referencias se les aplicará un cargo de 10 €
 2. Pedidos inferiores a 10 referencias se les aplicará un cargo de 15 €
 3. Pedidos inferiores a 15 referencias se les aplicará un cargo de 20 €
 4. Pedidos inferiores a 25 referencias se les aplicará un cargo de 35 €
- El envío será por “Transporte Urgente” con compromiso de entrega en 24 horas, a excepción de las Islas Canarias. En estos casos, el transporte será a cargo del cliente.

4. Reclamaciones, retrasos y fuerza mayor

No se aceptarán bajo ninguna circunstancia reclamaciones relativas al estado de la mercancía o a errores de envío tras 15 días laborables desde la recepción de esta.

Las reclamaciones por falta de materiales u otros errores en la entrega deben efectuarse por escrito ante el vendedor en el plazo de 15 días laborables tras la recepción del envío; y el hecho de no notificar dicha reclamación supone la aceptación absoluta y la renuncia a cualquier reclamación por parte del comprador. Las reclamaciones por pérdidas o daños en los productos durante el transporte deben efectuarse ante el transportista y no ante el vendedor. **NUUESTRA RESPONSABILIDAD POR EL ENVÍO FINALIZA CON LA ACEPTACIÓN DE ESTE POR PARTE DE LOS TRANSPORTISTAS.**

Todas las fechas de entrega son aproximadas. El retraso en la entrega de cualquier envío no exime al comprador de su obligación de aceptar los envíos restantes. Además, el vendedor no será responsable por las pérdidas o los daños que resulten de los retrasos o de la falta de entrega por cualquier causa fuera del control razonable del vendedor, incluyendo sin limitación fuerza mayor, actos del comprador, embargo u otro acto, norma o petición gubernamental, incendio, accidente, huelga, parones, guerra, acto de terrorismo, disturbios, retraso en el transporte o incapacidad para conseguir la mano de obra, los materiales o las instalaciones de producción necesarios. En caso de algún retraso de este tipo, la fecha de entrega se ampliará durante un plazo igual al tiempo perdido debido al retraso. El único remedio del comprador por otros retrasos y por la incapacidad del vendedor de efectuar la entrega por cualquier motivo será la rescisión de su contrato de compra.

5. Modificaciones

En cualquier momento, el vendedor podrá realizar modificaciones en el diseño y la construcción de los productos, los componentes o las partes como el vendedor lo crea apropiado, sin previo aviso al comprador. El vendedor puede ofrecer sustitutos apropiados del material no disponible debido a las prioridades o normas establecidas por la autoridad gubernamental o la falta de materiales por parte de los proveedores.

6. Garantía

El vendedor garantiza que cualquier utensilio de cocina subministrado en virtud del presente está libre de disconformidad con cualquier especificación adjunta y libre de defectos en los materiales y la calidad, que aparezcan en el plazo de 60 días. El vendedor también garantiza que cualquier equipo subministrado en virtud del presente está libre de disconformidad con cualquier especificación adjunta y libre de defectos en los materiales y la calidad, que aparezcan en el plazo de 18 meses desde la fecha de envío o 12 meses desde la fecha de compra por el usuario final, lo que ocurra antes. Si en dichos plazos cualquier producto pertinente se demuestra a satisfacción del vendedor que es defectuoso, la pieza afectada será reparada o sustituida sin cargo, bajo FCA destino original del comprador, o el vendedor devolverá el precio de compra de la parte afectada. La reparación, la sustitución o la devolución (lo que el vendedor determine, a su discreción) constituirá la única obligación del vendedor y el único remedio del comprador para cualquier deficiencia en los productos subministrados en virtud del presente, y estará condicionada por la devolución de dichos productos al vendedor por parte del comprador, bajo DDP muelle de carga del vendedor (según la definición de este último en Incoterms 2010). Cualquier pieza reparada o sustituida en virtud de esta garantía se garantiza solo durante el período restante de garantía sobre la pieza que ha sido reparada o sustituida. El vendedor no garantiza productos que hayan sido dañados por accidente, imprudencia, instalación indebida, configuración o supervisión (cuando proceda) inadecuadas o que hayan sido instalados o puestos en funcionamiento de cualquier modo que sea contrario a las instrucciones de instalación y funcionamiento. El vendedor no garantiza ningún servicio de reparación efectuado por personal no autorizado o agencias de servicios no autorizadas.

LAS GARANTÍAS ANTERIORES SON EXCLUSIVAS Y SUSTITUYEN TODAS LAS OTRAS ASEVERACIONES Y GARANTÍAS, EXPRESAS O IMPLÍCITAS; Y EL VENDEDOR NO ACEPTA Y EXCLUYE EXPRESAMENTE CUALQUIER GARANTÍA IMPLÍCITA DE COMERCIALIZACIÓN O IDONEIDAD PARA CUALQUIER PROPÓSITO PARTICULAR, Y CUALQUIER GARANTÍA QUE PUEDA SURGIR DE UN ACUERDO O USO COMERCIAL.

7. Cancelaciones y devoluciones

Ningún pedido podrá ser cancelado ni modificado por el comprador excepto en virtud de los términos y condiciones que pueda aceptar el vendedor, tal como lo indique el consentimiento escrito del vendedor.

Se solicitará una autorización de devolución para todas las devoluciones. **SE RECHAZARÁN** las devoluciones de productos que no cuenten con la autorización previa por parte de la oficina del vendedor de Santa Coloma de Farners.

PUJADAS tiene libertad para autorizar y devolver y puede decidir rechazar la devolución según su propio criterio.

a. Las solicitudes de devoluciones de mercancía (que no sea mercancía defectuosa) deben efectuarse en el plazo de **90 DÍAS desde la FECHA DE LA FACTURA DE PUJADAS. DEBE INDICARSE EL NÚMERO DE ORDEN DE COMPRA o EL NÚMERO DE FACTURA DE PUJADAS al solicitar la autorización. NO SE EMITIRÁ NINGUNA AUTORIZACIÓN DE DEVOLUCIÓN a menos que se proporcione el número de orden de compra o el número de factura de Pujadas.**

b. Se aplicará un cargo por reposición de existencias como se indica a continuación: Para cualquier devolución se cargará un 20% del importe, por demérito y gestión, con un mínimo de 10 €.

c. Las devoluciones o los envíos de materiales a las instalaciones de PUJADAS para su pago, sustitución o reparación deberán efectuarse siempre por flete prepagado.

d. El número de autorización de la devolución deberá marcarse en todos los embalajes de los productos que se devuelvan.

e. Únicamente se aceptarán devoluciones de mercancía actual en su embalaje original, sin usar y en estado vendible. La mercancía devuelta que haya sido usada, esté obsoleta o desgastada se eliminará y NO se emitirá crédito.

1. La devolución de ESTANTERÍAS solo se efectuará si van en su embalaje completo, en palés si constan de más de un bulto y protegidas con film de plástico por encima.

2. La devolución de CARROS se efectuará en palés y con el embalaje protector completo.

f. Los siguientes productos no pueden devolverse: (1) utensilios de cocina a medida, (2) clips personalizados, (3) equipos personalizados. Tampoco se aceptará la devolución de materiales en los que PUJADAS haya efectuado alguna adaptación concreta para satisfacer el pedido.

8. Patentes, marcas comerciales y copyright

El vendedor, únicamente a su cargo, se defenderá de cualquier demanda realizada por cualquier persona contra el comprador por presunta violación de una patente de la Unión Europea, marca comercial o copyright relacionada con los productos o servicios ofrecidos por el vendedor en virtud del presente, y pagará cualquier indemnización por daños que se otorgue en firme, siempre y cuando el comprador haya realizado todos los pagos en virtud del presente y notifique por escrito al vendedor dicha demanda de inmediato, y transmita de inmediato al vendedor todas las notificaciones procesales y documentos recibidos, y permita al vendedor, a través de su abogado, defenderse de esta o resolverla, ya sea en nombre del comprador o del vendedor, y suministre toda la información, asistencia y autoridad necesarias para permitir al vendedor que así lo haga. Además, si el resultado de cualquier demanda es una resolución o un reconocimiento de infracción, el vendedor deberá, a elección del vendedor: (a) obtener para el comprador el derecho de continuar usando los bienes o productos o los servicios adquiridos del comprador, (b) sustituirlos con productos o servicios que no supongan ninguna infracción, (c), modificar dichos productos o servicios de manera que no supongan ninguna infracción, o (d) eliminar dichos bienes o productos o servicios y reembolsar al comprador la parte no devaluada del precio de compra, considerando una vida útil de cinco años.

En cuanto a los productos o servicios que el vendedor suministra al comprador fabricados partiendo de dibujos, diseños o especificaciones propuestas o suministradas por el comprador, el vendedor no será responsable y el comprador deberá indemnizar y eximir de responsabilidad al vendedor ante cualquier pérdida, responsabilidad, daño, reclamación y gasto (incluyendo sin limitación los honorarios razonables de los abogados del vendedor y otros costes de defensa) incurridos por el vendedor como resultado de una demanda por patente, marca comercial, copyright o violación del secreto comercial, o violación de otro derecho sobre la propiedad de terceros.

9. Perjuicios y otra responsabilidad; indemnización

La responsabilidad del vendedor respecto de los productos o servicios que se vendan en virtud del presente se limitará a la garantía y la indemnización establecidas en las secciones 7 y 9 de los presentes términos y condiciones de venta y, respecto de cualquier otro incumplimiento de su contrato con el comprador, se limitará al precio del contrato. **EL VENDEDOR NO ESTARÁ SUJETO A OTRA OBLIGACIÓN O RESPONSABILIDADES, YA SEA QUE SURJAN DE UN INCUMPLIMIENTO DE CONTRATO, GARANTÍA, ILÍCITO CIVIL (INCLUYENDO NEGLIGENCIA Y RESPONSABILIDAD POR HECHOS AJENOS) U OTRAS DOCTRINAS, RESPECTO DE LOS PRODUCTOS O LOS SERVICIOS OFRECIDOS POR EL VENDEDOR, O CUALQUIER EMPRENDIMIENTO, ACCIÓN U OMISIÓN RELACIONADA CON ESTOS.** Sin limitar el carácter general de lo antedicho, el vendedor específicamente rechaza cualquier responsabilidad por daños a la propiedad, multas, daños cuantificables o punitivos, daños por lucro cesante, inactividad, pérdida de clientela, coste de capital, coste de sustitución de productos o servicios, o cualquier otro tipo de pérdida de ventaja económica, o demandas de los clientes del comprador o de cualquier tercero por dichos daños, costes o pérdidas.

EL VENDEDOR NO SERÁ RESPONSABLE Y NO ACEPTA LA RESPONSABILIDAD POR PERJUICIOS, DAÑOS FORTUITOS, INDIRECTOS Y ACCIDENTALES DE CUALQUIER NATURALEZA.

El comprador eximirá y liberará al vendedor de cualquier pérdida, responsabilidad, daños y gastos (incluyendo sin limitación honorarios razonables de abogados y otros costes de defensa) en que pueda incurrir el vendedor como resultado de cualquier demanda del comprador, de los clientes del comprador o de cualquier tercero derivados de los productos y servicios que se vendan en virtud del presente o relacionados con estos, a menos que se determine en última instancia que dichas pérdidas, responsabilidades, daños o gastos son atribuibles únicamente a la conducta premeditada del vendedor.

10. Precios.

Los precios de venta son los que se especifican en nuestras tarifas, en referencia a la mercancía de nuestro almacén de Santa Coloma de Farners con embalaje de cartón no retornable.

11. Fotografías, información y medidas

Las fotografías, la información y las medidas indicadas en el catálogo del vendedor pueden sufrir cambios, sin previo aviso, debido a requisitos técnicos o de producción.

12. Protección de datos personales.

De conformidad con lo establecido en la normativa vigente en materia de protección de datos de carácter personal, VOLLRATH PUJADAS, S.A.U informa al comprador que los datos personales recogidos durante la relación comercial serán tratados e incorporados en los ficheros del vendedor, con el objetivo de poder prestar los servicios solicitados, así como también para mantenerlo informado de nuevos productos y servicios. Los datos facilitados se conservarán mientras se mantenga la relación comercial y una vez finalizada se conversarán aquellos que vengan exigidos por la legislación tributaria. En cualquier momento usted podrá ejercer los derechos de acceso, rectificación o supresión, limitación del tratamiento, portabilidad y oposición mediante una petición escrita a info@pujadas.es, acompañada de una fotocopia de su DNI/NIF. También podrá dirigirse a la Autoridad de Control competente para presentar la reclamación que considere oportuna.

Quedan reservados todos los derechos de cambio sin aviso previo, en especial colores o precios para los artículos que aparecen en este catálogo.

Fotografías no contractuales.

GENERAL SELLING CONDITIONS

ENGLISH

1. Governing Provisions

All sales by PUJADAS – A Vollrath Company ("Seller") are subject to these terms and conditions, and are expressly conditioned upon assent to these terms and conditions. No additional or different terms or conditions will be binding upon Seller unless specifically agreed to in writing. Seller hereby objects to any such additional or different terms, and notifies buyer that Seller is unwilling to sell on any terms other than these terms and conditions. Each contract of sale, including these terms and conditions shall constitute the entire agreement between Seller and buyer, and shall be governed by, construed and interpreted according to the laws of Spain, without reference to Principles of Conflicts of Laws. The rights and obligations of the Parties hereunder shall not be governed by the 1980 U.N. Convention on Contracts for the International Sale of Goods; and both parties hereby expressly submit to the jurisdiction of the Courts of Barcelona (Spain), in respect of any proceedings arising out of or in connection with the present General Selling Conditions. There are no conditions affecting the parties' agreement which are not expressed in these terms and conditions.

2. Taxes and Other Charges

Any manufacturer's tax, occupation tax, use tax, sales tax, excise tax, value added tax, duty, custom, inspection or testing fee, or any other tax, fee, interest or charge of any nature whatsoever imposed by any governmental authority on or measured by the transaction between Seller and buyer shall be paid by buyer in addition to the prices quoted or invoiced. In the event Seller is required to pay any such taxes or other charges, buyer shall reimburse Seller therefore on demand.

3. Delivery and Freight

All items are delivered FCA point of origin (Incoterms 2010). Except as provided below, orders made from the area of the Peninsula and the Balearic Islands with a value over 500 € (1,400 € in Canary Islands) or more shipping to one location will be shipped PREPAID by Seller. Orders with a value below 500 € will be assessed a 20 € freight charge. (55 € in Canary Islands). For ultimate destinations outside of Spain, all items are FCA Seller's loading dock (as the latter shipping term is defined in Incoterms 2010). Delivery of products to the carrier shall constitute delivery to buyer; and regardless of shipping terms or freight payment, buyer shall bear all risk of loss or damage in transit. Seller reserves the right to make delivery in multiple shipments, unless otherwise expressly stipulated herein; all such shipments to be separately invoiced and paid for when due per invoice, without regard to subsequent deliveries. Seller reserves ownership rights over all the materials supplied until full payment of the same.

a. Minimum Order Amount and Drop Ship Orders

A 6 € minimum order charge will apply to orders less than One Hundred Euro (100 €) NET. Seller reserves the right to refuse requests to drop ship orders for the same products to one or multiple locations.

b. Quantity

The materials will be supplied in complete packaging containing the quantity indicated in our rates.

c. Custom Smallwares

Custom Smallwares orders are completed with over/under shipments, not to exceed plus or minus 10% of the original order quantity.

4. Claims, Delays and Force Majeure

Under no circumstances shall claims concerning the condition of the merchandise or regarding shipping mistakes be accepted once 15 workdays have elapsed since the reception thereof.

Claims for shortages or other errors in delivery must be made in writing to Seller within 15 working days after receipt of shipment; and failure to give such notice shall constitute unqualified acceptance and a waiver of all such claims by buyer. Claims for loss of or damage to goods in transit must be made to the carrier, and not to Seller. OUR RESPONSIBILITY FOR SHIPMENT CEASES WITH ACCEPTANCE BY CARRIERS.

All delivery dates are approximate. Delay in delivery of any shipment shall not relieve buyer of its obligations to accept remaining shipments. Further, Seller shall not be liable for any losses or damages as a result of any delay or failure to deliver due to any cause beyond Seller's reasonable control, including but not limited to any act of God, act of buyer, arrest or other governmental act, regulation or request, fire, accident, strike, slowdown, war, act of terrorism, riot, delay in transportation, or inability to obtain

necessary labor, materials or manufacturing facilities. In the event of any such delay, the date of delivery shall be extended for a period equal to the time lost because of the delay. Buyer's exclusive remedy for other delays and for Seller's inability to deliver for any reason shall be rescission of its agreement to purchase.

5. Changes

Seller may at any time make such changes in design and construction of products, components or parts as Seller deems appropriate, without notice to buyer. Seller may furnish suitable substitutes for materials unobtainable because of priorities or regulations established by governmental authority or non-availability of materials from suppliers.

6. Warranties

Seller warrants any smallwares provided hereunder to be free from nonconformity to any attached specifications, and free of defects in materials and workmanship, appearing within 60 days. Seller also warrants any equipment provided hereunder to be free from nonconformity to any attached specifications, and free of defects in materials and workmanship, appearing within 18 months from date of shipment or 12 months from date of purchase by the end user, whichever ends earlier. If within such periods any such applicable goods shall be proved to Seller's satisfaction to be defective, the affected part will be repaired or replaced free of charge, FCA buyer's original destination, or Seller will refund the purchase price of the affected part. Such repair, replacement or refund (whichever Seller determines, in its discretion, to provide) shall be Seller's sole obligation and buyer's exclusive remedy for any deficiency in goods furnished hereunder, and shall be conditioned upon buyer's return of such goods to Seller, ., DDP Seller's loading dock (as the latter shipping term is defined in Incoterms 2010). Any parts repaired or replaced under this warranty are warranted only for the balance of the warranty period on the part that was repaired or replaced. Seller gives no warranty on any goods damaged by accident, carelessness, improper installation, lack of proper setup or supervision (when required) or installed or operated in any manner contrary to the installation and operating instructions. Seller gives no warranty on any repair services performed by unauthorized personnel or unauthorized service agencies.

THE ABOVE WARRANTIES ARE EXCLUSIVE AND IN LIEU OF ALL OTHER REPRESENTATIONS AND WARRANTIES, EXPRESS OR IMPLIED; AND SELLER EXPRESSLY DISCLAIMS AND EXCLUDES ANY IMPLIED WARRANTY OF MERCHANTABILITY OR FITNESS FOR ANY PARTICULAR PURPOSE, AND ANY WARRANTIES ARISING FROM COURSE OF DEALING OR USAGE OF TRADE.

7. Cancellations and Returns.

No order may be cancelled or altered by buyer except upon terms and conditions acceptable to Seller, as evidenced by Seller's written consent. Return Authorizations must be requested for all returns. Product returned without prior authorization from Seller's Santa Coloma de Farners office WILL BE REFUSED. PUJADAS is free to authorize the return and can decide refuse the return by its free criterion.

a. Requests for returns of merchandise (other than defective merchandise) must be made within **90 DAYS of the PUJADAS INVOICE DATE. PURCHASE ORDER NUMBER or PUJADAS INVOICE NUMBER MUST BE PROVIDED when requesting the authorization. NO RETURN AUTHORIZATION will be issued unless Purchase Order Number or PUJADAS Invoice Number is provided.**

b. A restocking charge applies as follows:

1. Merchandise less than 50 € value – 10 € restocking charge.
2. Merchandise more than 50 € value – 20% restocking charge.

c. The returns or shipments of materials to the facilities of PUJADAS whether for payment, replacement or repair should always be made by prepaid freight.

d. Return Authorization Number must be marked on all returned cartons.

e. Returns accepted only on current merchandise found in original carton and in new and saleable condition. Merchandise returned that is used, obsolete or shelf-worn will be disposed of and credit **WILL NOT** be issued.

1. The return of **SHELVING** shall only be performed in complete packaging, on pallets if it is more than one packaging and with plastic film protection over the same.

2. The return of **TROLLEYS** shall be made on pallets and with complete protective packaging.

f. The following items may not be returned: (1) Custom Smallware, (2)

Personalized flaps or clips, (3) Custom Equipment
Neither shall the return of materials be admitted in which PUJADAS has performed some specific adaptation to comply with the order.

8. Patents, Trademarks and Copyrights

Seller will, at its own expense, defend any suits that may be instituted by anyone against buyer for alleged infringement of any European Union patent, trademark or copyright relating to goods or services provided by Seller, and pay any final damage award therein, provided buyer shall have made all payments then due hereunder; shall give Seller immediate notice in writing of any such suit, shall transmit to Seller immediately upon receipt all processes and papers served upon buyer, and shall permit Seller, through its counsel, to defend or settle the same either in the name of buyer or in the name of Seller, giving Seller all needed information, assistance and authority to enable Seller to do so. Further, if the result of any such suit is a determination or acknowledgement of infringement, Seller shall, at Seller's option (a) obtain for buyer the right to continue to use the goods or products of the services purchased from Seller, or (b) replace the same with non-infringing goods or services, or (c) modify such goods or services so that they are non-infringing, or (d) remove such goods or products of services and refund to buyer the undepreciated portion of the purchase price, determined on the basis of a five-year useful life.

To the extent that any goods or services that Seller furnishes to buyer are manufactured in accordance with drawings, designs or specifications proposed or furnished by buyer, Seller shall not be liable, and buyer shall indemnify and hold harmless Seller from and against any and all losses, liabilities, damages, claims and expenses (including but not limited to Seller's reasonable attorneys' fees and other costs of defense) incurred by Seller as a result of any claim of patent, trademark, copyright or trade secret infringement, or infringement or any other proprietary rights of third parties.

9. Consequential Damages and Other Liability; Indemnity

Seller's liability with respect to the goods or services sold hereunder shall be limited to the warranty and indemnity provided in sections 7 and 9 of these terms and conditions of sale and, with respect to any other breaches of its contract with buyer, shall be limited to the contract price.

SELLER SHALL NOT BE SUBJECT TO ANY OTHER OBLIGATIONS OR LIABILITIES, WHETHER ARISING OUT OF BREACH OF CONTRACT, WARRANTY, TORT (INCLUDING NEGLIGENCE AND STRICT LIABILITY) OR UNDER OTHER THEORIES OF LAW OR EQUITY, WITH RESPECT TO GOODS OR SERVICES SOLD BY SELLER, OR ANY UNDERTAKINGS, ACTS OR OMISSIONS RELATING

THERE TO. Without limiting the generality of the foregoing, Seller specifically disclaims any liability for property damages, penalties, special or punitive damages, damages for lost profits or revenues, down-time, lost good will, cost of capital, cost of substitute goods or services, or for any other types of loss of economic advantage, or for claims of buyer's customers or any third party for any such damages, costs or losses.

SELLER SHALL NOT BE LIABLE FOR AND DISCLAIMS ALL CONSEQUENTIAL, INCIDENTAL, INDIRECT AND CONTINGENT DAMAGES WHATSOEVER.

Buyer shall indemnify and hold harmless Seller from and against any and all losses, liabilities, damages and expenses (including but not limited to attorneys' fees and other costs of defense) that Seller may incur as a result of any claim by buyer or by buyer's customers or by any third party arising out of or in connection with the goods or services sold hereunder, unless such losses, liabilities, damages or expenses are ultimately determined to be attributable solely to the willful misconduct of Seller.

10. Prices

The selling prices are those specified in our rates, in reference to the merchandise in our warehouse of Santa Coloma de Farners with non-returnable cardboard packaging.

11. Photos, Data and Measurements

The photos, data and measurements in the Seller's catalogue are subject to change, without prior notice, due to technical or production requirements.

12. Personal Data Protection

In accordance with the provisions of current legislation on the Protection

of Personal Data, VOLLRATH PUJADAS, S.A.U informs the buyer that the personal data collected during the commercial relationship will be processed and incorporated into the seller's files, with the aim of being able to provide the services requested, as well as to keep the buyer informed of new products and services. The data provided will be kept as long as the commercial relationship is maintained and, once it has ended, to meet those requests required under tax legislation. The buyer may, at any time, exercise the rights of access, rectification or erasure, restriction of processing, data portability and opposition by means of a written request to info@pujadas.es, accompanied by a photocopy of your DNI/NIF (National Identity Document/Tax Identification Number). You can also contact the competent Control Authority to submit any complaint that you consider appropriate.

All rights reserved to make changes, without prior notice to articles that appear in this catalogue, particularly in relation to colours and/or prices.

Photographs do not form part of the contract.

CONDITIONS GENERALES DE VENTE

FRANÇAIS

1. Dispositions applicables.

Toutes les ventes réalisées par PUJADAS – A Vollrath Company ("Le Vendeur") sont soumises à ces termes et conditions générales, et sont expressément conditionnées à l'acceptation de ces termes et conditions générales. Aucune modalité ou conditions générales différentes ou supplémentaires ne s'imposeront au Vendeur, sauf accord stipulé par écrit. Le vendeur s'oppose à l'ajout de modalités et de conditions différentes et informe l'acheteur que le Vendeur n'est pas disposé à vendre ses produits sous tout autre terme que ces termes et conditions.

Chaque contrat de vente, incluant ces termes et conditions constituera l'accord intégrale entre le Vendeur et l'acheteur, et sera régi par, et interprété conformément aux lois espagnoles, sans égard à aucun principe de conflit de lois. Les droits et obligations des Parties au contrat ne seront pas régis par la Convention 1980 des Nations Unies sur les Contrats de Vente Internationale de marchandise ; et les deux parties au contrat se soumettent expressément à la juridiction des tribunaux de Barcelone (Espagne) pour toute procédure découlant ou en relation avec les présentes conditions générales de vente. Il n'y a pas de conditions affectant l'accord entre les deux parties au contrat qui ne sont pas exprimés dans ces termes et conditions.

2. Taxes and Autres Frais

Toute taxe de fabricant, taxe d'occupation, taxe d'utilisation, taxe de vente, taxe d'accise, taxe sur la valeur ajoutée, droit de douane, taxe d'inspection ou d'examen, ou toute autre taxe, frais, intérêts ou frais de quelque nature que ce soit imposés par une autorité gouvernementale ou mesures pour la transaction entre le Vendeur et l'acheteur doit être payé par l'acheteur en plus du prix estimé ou facturé. Dans l'éventualité où le Vendeur serait tenu de payer de telles taxes ou autres frais, l'Acheteur devra les lui rembourser sur demande.

3. Livraison et fret

Tous les articles sont livrés FCA point d'origine (Incoterms 2010). A l'exception des dispositions ci-dessous, les commandes effectuées depuis la péninsule et depuis les Iles Baléares avec une valeur supérieure à 500 € (1,400 € pour les Iles Canaries) ou plus d'expéditions à un endroit seront expédiées PREPAID (PRÉPAYÉ) par le Vendeur. Les commandes d'une valeur inférieure à 500€ seront évaluées de frais de fret de 20€. (55€ aux Iles Canaries) Pour les commandes dont la destination finale est en dehors d'Espagne, les produits sont livrés FCA dock de chargement du Vendeur (ceci étant défini par les conditions d'expédition des Incoterms 2010). La livraison des produits au transporteur constituera la livraison à l'acheteur ; ce qui signifie qu'indépendamment des conditions d'expédition ou de paiement du fret, l'acheteur doit supporter tous les risques de perte ou de détérioration liés au transport. Le Vendeur se réserve le droit de procéder à la livraison en plusieurs envois, sauf si le contraire est expressément stipulé ci-inclus. Tous les envois multiples devront être facturés et payés séparément au moment de la facturation, sans tenir compte des livraisons ultérieures.

Le Vendeur se réserve le droit de propriété sur tous les produits fournis jusqu'au paiement complet de ces derniers.

a. Montant minimum de la commande et commandes Drop Ship

Des frais minimums de 6 € seront appliqués aux commandes inférieures à 100 € NET.

Le Vendeur se réserve le droit de refuser des demandes de dropshipping pour les mêmes produits à destination d'une ou plusieurs localités.

b. Quantité

Les matériaux seront fournis dans un emballage complet contenant la quantité indiquée dans nos tarifs.

c. Ustensiles personnalisés

Les commandes d'ustensiles personnalisés sont complétées avec des envois inférieurs ou supérieurs, ne dépassant pas plus ou moins 10% de la commande originale.

4. Réclamations, Retards et Force Majeure

En aucun cas, les réclamations concernant l'état de la marchandise ou des erreurs de livraison ne seront acceptées une fois que 15 jours ouvrables se sont écoulés depuis leur réception.

Les réclamations pour manque de produits ou tout autre erreur de livraison doivent être faites par écrit au Vendeur dans les 15 jours ouvrables suivant la réception de la marchandise. L'omission de donner un tel avis constituera une acceptation sans réserve et une renonciation à toute réclamation

ultérieure de l'acheteur. Les réclamations pour perte ou détériorations sont à effectuer auprès du transporteur et non de l'acheteur. NOTRE RESPONSABILITÉ QUAND AU TRANSPORT CESSE APRÈS ACCEPTATION DU TRANSPORTEUR.

Toutes les dates de livraison sont approximatives. Le retard d'une livraison ne libère pas l'acheteur de son obligation d'accepter les envois restants. En outre, Le Vendeur ne serait pas être tenu responsable des pertes ou des dégradations résultant d'un retard ou d'un défaut de livraison en raison de circonstances ou d'événements indépendants de la volonté du Vendeur, incluant sans s'y limiter tout acte de Dieu, d'actes émanant de l'acheteur, d'actes gouvernementaux, de règlements ou demandes, feu, accident, grève, ralentissement, guerre, acte de terrorisme, émeute, retard dans le transport, incapacité d'un travailleur, défaillance du matériel ou des installations du fabricant. En cas de retard, la date de livraison est prolongée pour une période égale au temps perdu en raison du retard. Le recours exclusif de l'acheteur pour d'autres retard et pour l'incapacité du Vendeur à livrer la marchandise peut être l'annulation du contrat d'achat.

5. Modifications

Le Vendeur peut à tout moment effectuer des changements concernant la conception ou la construction des produits, des composants ou de pièces si le Vendeur les juge appropriés, sans le notifier à l'Acheteur. Le Vendeur peut fournir des substituts appropriés pour les matériaux impossibles de se procurer à cause de priorités ou de règlements imposés par une autorité gouvernementale ou en cas de non disponibilités des matériaux auprès des fournisseurs.

6. Garanties

Le vendeur garantit que tous les produits fournis en vertu des présentes CGV sont exempts de non-conformité aux spécifications ci-jointes, et sans défauts de fabrications apparaissant dans les 60 jours. Le vendeur garantit également que tous les équipements fournis en vertu des présentes CGV sont exempts de non-conformité aux spécifications ci-jointes, et sans défauts de fabrications apparaissant dans les 18 mois suivant la date d'envoi ou dans les 12 mois suivant la date d'achat de l'utilisateur final, qui se termine plus tôt. Si au cours de ces périodes il était prouvé au Vendeur que les produits sont défectueux, la part correspondante serait remplacée gratuitement, FCA destination initiale de l'acheteur, ou le Vendeur rembourserait le prix d'achat de la part affectée. Une telle réparation, remplacement ou remboursement (que le Vendeur détermine et accepte à son gré) représente l'unique obligation du Vendeur et le recours exclusif de l'acheteur pour de tels défaut pour des produits fournis dans le cadre de ces conditions générales de vente, et est conditionné au retour des produits par l'acheteur au Vendeur, DDP au dock d'expédition du Vendeur (ceci étant défini par les conditions d'expédition des Incoterms 2010). Toute pièce réparé ou remplacé dans le cadre de cette garantie est garantie seulement sur le solde de la période de garantie de la pièce réparée ou remplacée. Le vendeur ne garantit aucun produit endommagé par accident, négligence, mauvaise installation, manque de maintenance (le cas échéant) ou installation ou utilisation contraires aux instructions d'installation et d'utilisation. Le vendeur n'offre aucune garantie sur les services de réparation effectués par du personnel non autorisé ou des agences non autorisées.

LES GARANTIES CI-DESSUS SONT EXCLUSIVES ET EN LIEU ET PLACE DE TOUTES AUTRES REPRESENTATIONS OU GARANTIES, EXPRESSES OU IMPLICITES, ET LE VENDEUR DECLINE ET EXCLUT TOUTE GARANTIE IMPLICITE DE QUALITE MARCHANDE OU D'ADAPTATION A UN USAGE PARTICULIER, ET TOUTE GARANTIE POUVANT DECOULER DE RAPPORTS D'AFFAIRES OU DE PRATIQUES COMMERCIALES.

7. Résiliations et renvois

Ningún pedido podrá ser cancelado ni modificado por el comprador. Aucune commande ne saurait être annulée ou modifiée par l'acheteur excepté dans le cadre des termes et conditions acceptables pour le Vendeur, et avec le consentement écrit de ce dernier.

Des Autorisations de Renvoi doivent être sollicitées pour tout renvoi.

Les produits renvoyer sans autorisation préalable de la part des bureaux du Vendeur à Santa Coloma de Farners SERONT REFUSÉS. PUJADAS est libre d'autoriser le renvoi et peut décider de refuser le renvoi sur critères propres.

a. Les demandes de renvoi de marchandise (pour un motif autre que produits défectueux) doivent être faites dans les 90 JOURS suivant la DATE DE FACTURATION par PUJADAS. LE NUMÉRO DE COMANDE ou

LE NUMÉRO DE LA FACTURE DOIT ÊTRE FOURNI pour une demande d'autorisation. AUCUNE AUTORISATION DE RENVOI ne sera émise si le numéro de commande ou le numéro de facture n'est pas fourni.

b. Des frais de restockage s'appliquent de la façon suivante :

1. Marchandise d'une valeur inférieure à 50€ - 10 € de frais de restockage.
2. Marchandise d'une valeur supérieure à 50 € - 20% comme frais de restockage.

c. Les renvois ou les envois de produit à destination des installations de PUJADAS pour des raisons de paiement, de remplacement ou de réparation devraient toujours être effectués en fret payé d'avance.

d. Le Numéro de l'Autorisation de Retour doit être indiqué sur tous les cartons retournés.

e. Les renvois sont acceptés uniquement pour les produits actuels, trouvé dans leurs cartons d'origine, à l'état de neuf et pouvant être revendu. Les produits renvoyés, s'ils sont usés, obsolètes ou présentent des marques de manipulation seront élimés et le crédit **NE SERA PAS** émis.

1. Le renvoi de RAYONNAGE devra uniquement être effectué dans son emballage complet, sur palette s'il s'agit de plus d'un emballage, et avec un film plastique protecteur autour de ce dernier.

2. Le renvoi de CHARIOTS doit être effectué sur palette et avec l'emballage de protection complet.

f. Les produits suivants ne peuvent pas être renvoyés : (1) Les ustensiles personnalisés, (2) Les rabats et les pinces personnalisés, (3) les équipements personnalisés.

Le renvoi de produits pour lesquels PUJADAS a dû faire des adaptations pour honorer une demande, ne se pas accepté non plus.

8. Brevets, Marque Déposée et Copyrights

Le vendeur défendra, à ses frais, tout procès qui pourrait être engagé par un tiers contre l'acheteur pour la présumée violation d'un brevet, d'une marque déposée ou d'un copyright de l'Union Européenne en relation avec des produits ou des services fournis par le Vendeur, et il paiera toute indemnité finale en cas de dommage et intérêts, à condition que l'acheteur ait effectué tous les paiements dus, l'acheteur devra immédiatement informer par écrit le Vendeur d'une telle poursuite, il devra de façon immédiate transmettre au Vendeur et dès leur réception les procédures et les documents qui sont notifiés à l'acheteur et devra permettre au Vendeur, via son avocat, de défendre ou régler cette affaire soit au nom de l'acheteur soit au nom du Vendeur, en donnant au Vendeur toutes les informations nécessaires, l'assistance et l'autorité pour lui permettre de le faire. En outre si le résultat d'un tel procès est une condamnation ou la reconnaissance d'une infraction, le Vendeur devra, à l'option du Vendeur (a) obtenir pour l'acheteur le droit de continuer à faire usage des produits ou des services achetés au Vendeur ou (b) remplacer ces derniers par des produits ou des services non litigieux, ou (c) modifier ces produits ou ces services de façon à ce qu'ils ne soient plus litigieux, ou (d) retirer ces produits ou services et rembourser à l'acheteur une valeur inférieure au prix d'achat déterminé en se basant sur une durée de vie utile de 5 ans.

Dans la mesure où tous les produits ou services fournis à l'acheteur par le Vendeur sont fabriqués conformément aux dessins, aux plans ou aux spécificités proposés ou fournis par l'acheteur, le Vendeur ne sera pas responsable, et l'acheteur devra indemniser et décharger le Vendeur pour et contre toute sorte de perte, d'en-cours, de dommages et intérêts, de réclamations et de dépenses (notamment, mais sans s'y limiter les honoraires engagés par le Vendeur pour sa défense et les autres coûts liés à sa défense) engagés par le Vendeur à la suite d'une réclamation pour atteinte au brevet, à la marque déposée, au copyright ou à une atteinte au secret commercial, ou pour tout autre violation du droit de propriété d'un tiers.

9. Dommages Consécutifs et autres Responsabilités ; Indemnité

La responsabilité du vendeur à l'égard des produits et des services vendus en vertu des conditions présentes est limitée aux garanties et aux indemnités prévues aux articles 7 et 9 des présentes conditions générales de vente et, en ce qui concerne tout autre manquement au contrat qu'il a avec l'acheteur, l'indemnité est limitée au montant du contrat. **LE VENDEUR N'EST SOUMIS A AUCUNE AUTRES OBLIGATIONS OU RESPONSABILITES, DECOULANT D'UNE VIOLATION DU CONTRAT, DE GARANTIES, DE TORTS (INCLUANT LES NEGLIGENCES OU LES RESPONSABILITES STRICTES) OU DANS LE CADRE D'AUTRES THEORIES LEGALES, RELATIVES AUX PRODUITS ET AUX SERVICES VENDUS PAR LE VENDEUR, OU TOUT AUTRE ENGAGEMENT OU OMISSION RELATIF EN CELA.**

Sans limiter la portée de ce qui précède, le vendeur décline expressément toute responsabilité pour les dommages matériels, les pénalités, les dommages spéciaux ou punitifs, les dommages pour la perte de profits ou de revenus, les pertes de temps, la perte de survaleur, le coût du capital, le coût de produits de substitution, ou pour tout autre perte d'un avantage économique ou pour les réclamations des clients de l'acheteur ou tout autre tiers pour de tels dommages, coûts ou pertes.

LE VENDEUR NE SERA PAS RESPONSABLE ET REJETTE TOUS LES DOMMAGES CONSÉCUTIFS, ACCESSOIRES, INDIRECTS ET ÉVENTUELS.

L'acheteur devra indemniser et décharger le Vendeur pour et contre toute sorte de perte, d'en-cours, de dommages et intérêts, et de dépenses (notamment, mais sans s'y limiter les honoraires engagés par le Vendeur pour sa défense et les autres coûts liés à sa défense) que le Vendeur peut encourir à la suite d'une réclamation de l'acheteur ou d'un client de l'acheteur ou d'un tiers découlant ou en relation avec les produits ou les services vendus selon les modalités des présentes, à moins que ces pertes, en-cours, dommages et intérêts ou dépenses ne soient finalement attribué uniquement à la seule faute intentionnelle du Vendeur.

10. Prix

Les prix de ventes sont ceux détaillés dans nos tarifs, faisant référence à la marchandise de notre entrepôt de Santa Coloma de Farners avec des emballages en carton non consignés.

11. Photos, Données et Dimensions

Les photos, données et dimensions présentes dans le catalogue du Vendeur sont susceptibles d'être modifiées, sans notification préalable, en raison d'exigences techniques ou de production.

12. Protection des données personnelles

Conformément à ce qu'établit la réglementation en vigueur en matière de protection de données à caractère personnel, VOLLRATH PUJADAS, S.A.U informe l'acheteur que les données personnelles collectées durant la relation commerciale seront traitées et stockées dans les fichiers du vendeur dans le but de pouvoir offrir les services requis ainsi que pour le tenir informé de nouveaux produits et services. Les données fournies seront conservées tant que durera la relation commerciale et, une fois celle-ci terminée, seules seront conservées celles exigées par la législation fiscale. À tout moment, vous pourrez exercer les droits d'accès, rectification ou suppression, limitation de traitement, portabilité et opposition moyennant demande par écrit adressée à info@pujadas.es, accompagnée d'une photocopie de votre numéro de pièce d'identité/numéro d'identification fiscale. Vous pourrez aussi vous adresser à l'autorité de contrôle compétente pour présenter la réclamation que vous jugerez pertinente.

Tous les droits de modification sans avis préalable sont réservés, en particulier les couleurs ou les prix des articles figurant dans ce catalogue.

Photographies non contractuelles.

1. Rechtshinweise

Alle durch PUJADAS – Ein Unternehmen der Vollrath-Gruppe (im Folgenden "der Verkäufer") realisierten Verkäufe unterliegen diesen Geschäftsbedingungen und sind ausdrücklich gebunden an die Zustimmung zu diesen Bestimmungen und Bedingungen. Für den Verkäufer sind keine anderen Bestimmungen oder Zusatzbedingungen bindend, es sei denn, hierzu erfolgt eine explizite schriftliche Vereinbarung. Hiermit stimmt der Verkäufer keinerlei anderen Bestimmungen oder Zusatzbedingungen zu und teilt dem Käufer mit, dass er keine Verkäufe zu anderen als den hier aufgeführten Geschäftsbedingungen realisiert. **Jeder Kaufvertrag, einschließlich dieser Geschäftsbedingungen, bildet eine untrennbare Vereinbarung zwischen Verkäufer und Käufer, unterliegt den spanischen Gesetzen und wird dementsprechend ausgelegt und verstanden, ohne dass die Grundsätze über Gesetzeskonflikte Anwendung finden. Die Rechte und Pflichten der Parteien gemäß dieser Geschäftsbedingungen unterliegen nicht den Vereinbarungen der Vereinten Nationen über internationale Kaufverträge von Waren aus dem Jahr 1980, und mit diesen Geschäftsbedingungen unterwerfen sich beide Parteien für alle Gerichtsverfahren, die aus diesen Allgemeinen Geschäftsbedingungen oder mit diesen verbundenen Bedingungen entstehen könnten, ausdrücklich der Jurisdiktion und den Gerichten von Barcelona (Spanien).** Es existiert keine Bedingung, die die Vereinbarung der Parteien betrifft, die nicht in diesen Allgemeinen Geschäftsbedingungen ausgedrückt ist.

2. Steuern und andere Kosten

Die Produktionssteuer, Belegsteuer, Nutzungssteuer, Verkaufssteuer, Verbrauchsteuer, Mehrwertsteuer, Gebühren, Kosten für Personalisierung, Prüfung oder Tests und alle anderen Steuern, Gebühren, Zinsen oder Kosten, die aufgrund der Transaktion zwischen dem Verkäufer und dem Käufer durch eine Regierungsbehörde auferlegt werden, werden vom Käufer bezahlt, ebenso wie die notierten oder in Rechnung gestellten Preise. Sollte der Verkäufer solche Steuern oder anderen Kosten übernehmen, muss der Käufer dem Verkäufer diese zurück erstatten.

3. Lieferung und Transport

Alle Produkte werden FCA Frei Frachtführer geliefert (Incoterms 2010). Mit den im Folgenden festgelegten Ausnahmen werden alle auf der Iberischen Halbinsel und den Balearen vorgenommenen Bestellungen, die einen Wert von mehr als 500 € haben (1400 € auf den Kanaren) nach VORKASSE vom Verkäufer versandt. Sendungen mit einem Wert von weniger als 500 € werden mit Versandkosten in Höhe von 20 € (55 € auf den Kanaren) belegt. Alle Sendungen mit Lieferort außerhalb Spaniens unterliegen FCA Verladerampe Verkäufer (gemäß der Definition in Incoterms 2010). Die Auslieferung der Produkte an den Transporteur wird als Auslieferung an den Käufer verstanden, und unabhängig von den Transportbedingungen oder -kosten, übernimmt der Käufer alle Risiken für Transportschäden oder -verluste. Der Verkäufer behält sich das Recht vor, die Lieferung in mehrere Teilsendungen aufzuteilen, es sei denn, es wird hier ausdrücklich das Gegenteil bestimmt. Die Teilsendungen werden einzeln in Rechnung gestellt und zum auf der entsprechenden Rechnung ausgewiesenen Datum bezahlt, unabhängig von späteren Lieferungen. Der Verkäufer behält sich das Eigentumsrecht aller versendeten Materialien vor, bis diese vollständig bezahlt wurden.

a. Mindestbestellwert und Bestellungen mit Direktlieferung

Für Bestellungen unter dem 100 € NETTO wird eine Gebühr von 6 € erhoben. Der Verkäufer behält sich das Recht vor, Bestellungen. Der Verkäufer behält sich das Recht vor, Bestellungen mit Direktlieferung für dieselben Produkte an eine oder mehrere Adressen nicht zu akzeptieren.

b. Menge

Die Materialien werden in ihrer vollständigen Verpackung, die die in unseren Preisen angegebenen Mengen enthält, geliefert.

c. Küchenutensilien nach Maß

Die Materialien werden in ihrer vollständigen Verpackung, die die in unseren Preisen angegebenen Mengen enthält, geliefert.

4. Reklamationen, Verzögerungen und höhere Gewalt

In keinem Fall werden Reklamationen in Bezug auf den Warenzustand oder Lieferfehler nach Ablauf von 15 Werktagen nach Erhalt der Ware akzeptiert.

Reklamationen von Materialfehlern oder anderen Mängeln bei der Lieferung müssen schriftlich innerhalb von 15 Werktagen nach Erhalt der Lieferung erfolgen, eine fehlende Reklamation bedeutet eine uneingeschränkte An-

nahme und den Verzicht auf jedwede Reklamation seitens des Käufers. Reklamationen aufgrund von Verlust von oder Schäden an den Produkten während des Transports müssen an den Transporteur und nicht an den Verkäufer gerichtet werden. UNSERE HAFTUNG IN BEZUG AUF DIE LIEFERUNG ENDET MIT DER ANNAHME DER WARE SEITENS DES TRANSPORTEURS.

Beim Lieferdatum handelt es sich um eine ungefähre Angabe. Eine Verzögerung jedweder Lieferung befreit den Käufer nicht von seiner Pflicht, die restlichen Lieferungen anzunehmen. Darüber hinaus haftet der Verkäufer nicht für Verluste oder Schäden, die sich aus Verzögerungen ergeben können, oder fehlende Lieferungen aus Gründen, die vernünftigerweise außerhalb der Kontrolle des Verkäufers liegen, einschließlich aber nicht beschränkt auf höhere Gewalt, Handlungen des Käufers, Embargo oder andere Handlungen, Richtlinien oder Anweisungen der Regierung, Brand, Unfall, Streik, Stillstand, Krieg, terroristische Akte, Unruhen, Transportverspätungen oder Unmöglichkeit, notwendige Arbeitskräfte, Materialien oder Produktionsstätten zu bekommen. Sollte eine Verzögerung dieser Art entstehen, wird die Lieferfrist um den aufgrund der Verzögerung verlorenen Zeitraum verlängert. Dem Käufer steht einzig die Möglichkeit einer Vertragsauflösung zur Verfügung, wenn eine Verzögerung aus anderen Gründen eintritt und der Verkäufer unfähig ist, die Lieferung zu realisieren.

5. Änderungen.

Der Verkäufer kann jederzeit nach seinem Ermessen Änderungen am Design und der Herstellung der Produkte, den Komponenten oder Teilen ohne Vorankündigung gegenüber dem Käufer vornehmen. Der Verkäufer kann geeigneten Ersatz für Material anbieten, das aufgrund von durch Regierungsbehörden festgelegte Prioritäten oder Richtlinien nicht verfügbar ist, oder wenn Zulieferer Materialien nicht liefern können.

6. Gewährleistung

Der Verkäufer haftet dafür, dass alle gemäß diesen Geschäftsbedingungen gelieferten Küchenutensilien jedweder angefügten Spezifizierung entsprechen und keine Fehler in Bezug auf Materialien und Qualität innerhalb von 60 Tagen aufweisen. Der Verkäufer haftet ebenfalls dafür, dass alle gemäß diesen Geschäftsbedingungen gelieferten Geräte jedweder angefügten Spezifizierung entsprechen und keine Fehler in Bezug auf Materialien und Qualität innerhalb der ersten 18 Monate ab Lieferung oder 12 Monate ab Datum des Kaufs durch den Endkunden auftreten, je nachdem, welcher Zeitraum zuerst endet. Sollte sich der Verkäufer innerhalb dieser Fristen zufrieden stellend überzeugen können, dass ein Produkt fehlerhaft ist, wird das entsprechende Teil kostenlos repariert oder ersetzt mit FCA ursprünglicher Lieferort des Käufers oder der Verkäufer erstattet des Kaufpreis des betroffenen teils zurück. Reparatur, Ersetzung oder Rückgabe (was der Verkäufer nach seinem Ermessen bestimmt) stellt die einzige Pflicht des Verkäufers und das einzige Mittel des Käufers dar in Bezug auf alle Mängel an den gelieferten Produkten gemäß dieser Geschäftsbedingungen und ist bedingt durch die Rückgabe der Produkte an den Verkäufer seitens des Käufers mittels DDP Verladerampe Verkäufer (gemäß der Definition in Incoterms 2010). Alle im Rahmen dieser Gewährleistung reparierten oder ersetzen Teile erhalten ausschließlich die restliche Gewährleistungszeit des ersetzten oder reparierten Teils. Der Verkäufer haftet nicht für Produkte, die durch Unfall, Fahrlässigkeit, unsachgemäße Installation, unangemessene Konfigurierung oder Überwachung (gegebenenfalls) beschädigt wurden, oder die auf eine Weise installiert oder in Betrieb genommen wurden, die nicht den Installations- oder Betriebsanweisungen entspricht. Der Verkäufer haftet nicht für Reparaturservices, die durch nicht autorisiertes Personal oder nicht autorisierte Serviceagenturen vorgenommen werden.

ES HANDELT SICH UM EINE AUSSCHLIEßLICHE GEWÄHRLEISTUNG, DIE ALLE ANDEREN VERSICHERUNGEN UND GEWÄHRLEISTUNGEN, OB AUSDRÜCKLICH ODER IMPLIZIT, ERSETZT, UND DER VERKÄUFER AKZEPTIERT KEINERLEI IMPLIZITE GEWÄHRLEISTUNG FÜR GEBRAUCHSTAUGLICHKEIT UND EIGNUNG FÜR JEDWEDEN BESONDEREN ZWECK ODER GEWÄHRLEISTUNGEN, DIE AUS KOMMERZIELLER VEREINBARUNG ODER NUTZUNG ENTSTEHEN KÖNNEN UND SCHLIEßT DIESE AUSDRÜCKLICH AUS.

7. Stornierungen und Rückgaben

Bestellungen können durch den Käufer weder storniert noch geändert werden, sofern dies nicht in den Bestimmungen und Bedingungen vorgesehen ist, die der Verkäufer akzeptiert hat, so wie in der schriftlichen

Einverständniserklärung des Verkäufers aufgeführt.

Für alle Rückgaben muss eine Rückgabegenehmigung beantragt werden. Produktrückgaben, die keine vorherige Rückgabegenehmigung durch das Büro des Verkäufers in Santa Coloma de Farners besitzen, werden ABGELEHNT.

PUJADAS hat die Freiheit, zu genehmigen und zurückzugeben und kann die Rückgabe nach eigenem Ermessen ablehnen.

a. Anträge auf Warenrückgabe (unbeschädigter Ware) müssen innerhalb einer Frist von **90 TAGEN ab RECHNUNGSDATUM VON PUJADAS erfolgen. Bei der Antragstellung sollte die BESTELLNUMMER oder die RECHNUNGNUMMER VON PUJADAS angegeben werden. Es werden keine RÜCKGABEGENEHMIGUNGEN ausgestellt, solange keine Angabe über die Bestellnummer oder die Rechnungsnummer von Pujadas erfolgt.**

b. Es wird eine Gebühr für Wiederauffüllung der Bestände wie folgt erhoben:
1. Ware mit einem Wert unter 50 €: 10 € Gebühr für Wiederauffüllung der Bestände.

2. Ware mit einem Wert über 50 €: 20% Gebühr für Wiederauffüllung der Bestände.

3. Rückgaben oder Materialsendungen an die Installationen von PUJADAS für ihre Bezahlung, Ersetzung oder Reparatur müssen immer mit im Voraus bezahltem Transport erfolgen.

c. Die Rückgabegenehmigungsnummer muss auf allen Verpackungen der Produkte, die zurückgegeben werden, markiert sein.

d. Es werden ausschließlich Rückgaben von Waren in Originalverpackung, ungenutzt und in verkäuflichem Zustand akzeptiert. Zurückgegebene Ware, die benutzt wurde, die obsolet oder abgenutzt ist, wird eliminiert und es erfolgt **KEINE** Rückerstattung.

1. Die Rückgabe von REGALEN kann nur in ihrer vollständigen Verpackung, auf Paletten, sollte es sich um mehr als ein Packstück handeln, und geschützt durch eine Plastikfolie erfolgen.

2. Die Rückgabe von WAGEN erfolgt auf Paletten und mit vollständiger Schutzverpackung.

e. Folgende Produkte sind von einer Rückgabe ausgeschlossen: (1) Küchensensoren nach Maß, (2) personalisierte Clips, (3) personalisierte Geräte.

Ebenfalls von der Rückgabe ausgeschlossen sind Materialien, an denen PUJADAS konkrete Anpassungen vorgenommen hat, um der Bestellung zu entsprechen.

8. Patente, Marken und Copyright

Der Verkäufer verteidigt sich, ausschließlich auf seine Kosten, gegenüber jedweder Klage, die jedwede Person gegen den Käufer wegen vermeintlicher Verletzung der Patentrechte der Europäischen Union, Marken- oder Copyright-Rechte anstrengt in Bezug auf die vom Verkäufer gemäß diesen Geschäftsbedingungen angebotenen Produkte oder Dienstleistungen und bezahlt jedwede Entschädigung, die rechtskräftig bewilligt wird, solange der Käufer alle Zahlungen gemäß dieser Geschäftsbedingungen geleistet hat, und dem Verkäufer schriftlich und unmittelbar über die Klage in Kenntnis setzt und dem Verkäufer über seinen Anwalt sofort alle Verfahrensmitteilungen und erhaltenen Unterlagen übermittelt, und den Verkäufer über seinen Anwalt befugt, die Klage zu verteidigen oder sie zu lösen, sowohl im Namen des Käufers als auch im Namen des Verkäufers, und ihm alle notwendigen Informationen, Hilfestellungen und Befugnisse zukommen lässt, damit dem Verkäufer dies möglich ist. Wenn das Ergebnis einer Klage eine Auflösung oder die Einräumung eines Verstoßes ist, sollte der Verkäufer außerdem, nach eigenem Ermessen: (a) für den Käufer das Recht erhalten, die vom Verkäufer erworbenen Waren und Produkte oder Dienstleistungen weiterhin zu nutzen, (b) sie durch Produkte oder Dienstleistungen ersetzen, die keine Verstöße bedeuten, (c), die fraglichen Produkte oder Dienstleistungen so verändern, dass sie keinen Verstoß mehr bedeuten oder (d) die Waren oder Produkte oder Dienstleistungen entfernen und dem Käufer den nicht geminderten Kaufpreis erstatten, wobei von einer Lebenszeit von fünf Jahren ausgegangen wird.

In Bezug auf Produkte oder Dienstleistungen, die der Verkäufer dem Käufer auf Basis von Zeichnungen, Entwürfen oder Spezifizierungen, die vom Käufer erstellt wurden, liefert, übernimmt der Verkäufer keine Haftung und der Käufer muss den Verkäufer für alle Verluste, Schäden, Reklamationen und Kosten (einschließlich aber nicht darauf beschränkt der vernünftigen Honorare für Anwälte des Verkäufers und andere Verteidigungskosten), die dem Verkäufer aus Klagen wegen Patent-, Marken- und Copyrightrechtsverstößen, Verletzung des Geschäftsgeheimnisses oder Verletzung anderer Eigentumsrechte Dritter, entschädigen und den Verkäufer von aller Haftung entbinden.

9. Schadensersatz und andere Haftungen

Die Haftung des Verkäufers in Bezug auf Produkte und Dienstleistungen, die gemäß diesen Geschäftsbedingungen verkauft werden, ist begrenzt auf die Gewährleistung und Entschädigungen, die unter Punkt 7 bis 9 dieser Geschäftsbedingungen festgelegt sind. In Bezug auf jede andere Nichterfüllung des Vertrags begrenzt sich die Haftung des Verkäufers auf den Vertragspreis. **DER VERKÄUFER UNTERLIEGT IN BEZUG AUF DIE PRODUKTE UND DIENSTLEISTUNGEN, DIE ER ANBIETET, ODER DAMIT VERBUNDENEN UNTERNEHMUNGEN, HANDLUNGEN ODER UNTERLASSUNGEN KEINEN WEITEREN PFLICHTEN ODER HAFTUNGEN, UNABHÄNGIG DAVON, OB ES SICH UM VERTRAGS-, GEWÄHRLEISTUNGS- ODER DELIKTHAFTUNG (EINSCHLIEßLICH FAHRLÄSSIGKEIT UND GEFÄHRDUNGSHAFTUNG) ODER ANDERWEITIGE HANDELT.** Ohne den allgemeinen Charakter des oben stehenden einzuschränken, lehnt der Verkäufer jede Haftung für Schäden am Eigentum, Strafgeldern, quantifizierbare und strafende Schäden, Schäden für entgangenen Gewinn, Inaktivität, Verlust von Kunden, Kapitalkosten, Kosten für die Ersetzung von Produkten und Dienstleistungen oder jede andere Art von Verlust von wirtschaftlichen Vorteilen oder Klagen von Kunden des Käufers oder Dritten bezüglich dieser Schäden, Kosten und Verluste, ab. **DER VERKÄUFER HAFTET NICHT UND ÜBERNIMMT KEINE HAFTUNG FÜR SCHADENSERSATZ UND ZUFÄLLIGE, INDIRECTE UND DURCH UNFALL ENTSTEHENDE SCHÄDEN JEDWEDER ART.**

Der Käufer nimmt den Verkäufer von allen Verlusten, Haftungen, Schäden und Kosten (einschließlich aber nicht darauf beschränkt der vernünftigen Honorare für Anwälte des Verkäufers und andere Verteidigungskosten), die dem Verkäufer als Ergebnis von Klagen des Käufers, Kunden des Käufers oder Dritten, die sich aus den Produkten und Dienstleistungen ableiten, die gemäß diesen Geschäftsbedingungen oder mit diesen verbunden verkauft werden, aus und befreit ihn davon, es sei denn, in letzter Instanz wird entschieden, dass diese Verluste, Haftungen, Schäden und Kosten ausschließlich einem bewussten Verhalten des Verkäufers zuzuschreiben sind.

10. Preise

Die Verkaufspreise werden in unseren Tarifen unter Bezug auf die Ware in unseren Lagern in Santa Coloma de Farners mit Einwegverpackungen spezifiziert.

11. Fotografien, Informationen und Maße

Die im Katalog des Verkäufers angegebenen Fotografien, Informationen und Maße können ohne vorherige Ankündigung aufgrund von technischen oder produktiven Anforderungen Änderungen unterliegen.

12. Datenschutz

In Übereinstimmung mit der gültigen Richtlinie über den Schutz personenbezogener Daten informiert VOLLRATH PUJADAS S.A.U. den Käufer, dass die während der Geschäftsbeziehung übermittelten Daten in eine Datei des Verkäufers aufgenommen und verarbeitet werden, um die angefragten Dienste leisten zu können, sowie Informationen über neue Produkte und Dienstleistungen zur Verfügung zu stellen. Die übermittelten Daten werden gespeichert, solange die Geschäftsbeziehung andauert. Nach Ende der Geschäftsbeziehung werden die Daten, für welche die Steuergesetzgebung dies vorschreibt, weiterhin aufbewahrt. Sie können jederzeit Ihr Recht auf Zugriff, Änderung oder Löschung, Verarbeitungseinschränkung, Portabilität und Widerspruch wahrnehmen, indem Sie sich schriftlich an info@pujadas.es wenden und eine Kopie Ihres Personalausweises anfügen. Sie können sich außerdem an die zuständige Kontrollbehörde wenden und eine Reklamierung einreichen, wenn Sie dies wünschen.

Alle Rechte auf Änderung ohne Vorankündigung, insbesondere bezüglich Farben oder Preise von Artikeln, die in diesem Katalog aufgeführt sind, sind vorbehalten.

Fotos gelten nicht verbindlich.

REF. CTPUJADAS2020



THE VOLLRATH COMPANY, L.L.C. HEADQUARTERS

1236 NORTH 18TH STREET
SHEBOYGAN, WISCONSIN 53081-3201 USA
CUSTOMER SERVICE: 920.457.4851
FAX: 920.459.6573
CREDIT: 920.459.5387

VOLLRATH PUJADAS SAU EMEA

CTRA. DE CASTANYET, 132
17430 STA. COLOMA DE FARNERS (GIRONA) - SPAIN
TEL: +34 972.84.32.01
EMAIL: INFO@PUJADAS.ES

VOLLRATH OF CHINA

VOLLRATH SHANGHAI TRADING LIMITED
29D, 855 SOUTH PU DONG ROAD
SHANGHAI, CHINA 200120
TEL: 86-21-50589580

VOLLRATH DE MEXICO S. DE R.L. DE C.V.

PERIFERICO SUR EDIFICIO 2-C
COL. SANTA MARÍA TEQUEPEPAN
45601 TLAQUEPAQUE, JALISCO MEXICO
TEL: (52) 333.133.6767 OR (52) 333.133.6769
FAX: (52) 333.133.6768

pujadas.es

vollrath.com

©2019 The Vollrath Company L.L.C.
An ISO 9001 Certified Company



Outperform every day.™

